

General information

Part number	S13LOC-P30PFG0-9200
Termination	crimp
Size	3
Locking principle	push
Coding	0_key
Cable Diameter	cable_mini_92
Cable outlet	standard

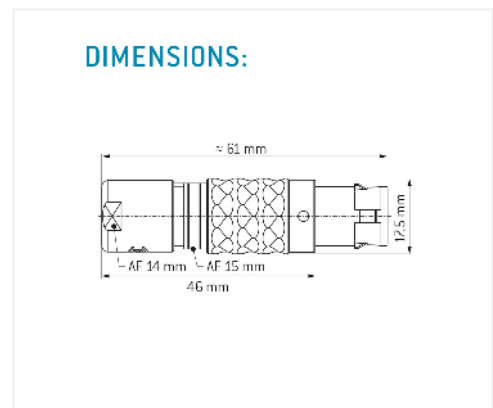
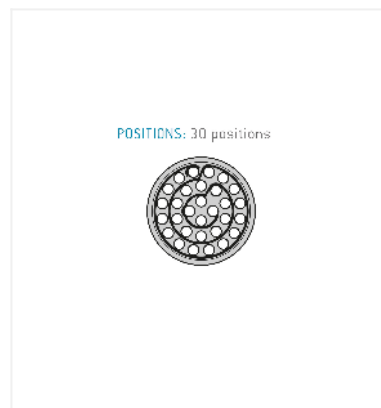

Contact insert description

Number of contacts	30
Contact type	pins
Contact diameter	07mm
Insulator material	peek
Wire cross section	22-26_awg
Termination	crimp

reverse_gender_on_request

Technical information

Max. creepage and air clearance distance	04_mm	10_mm
Nominal current single contact	075_a	iec_60512_5_2
Test voltage	09_kv_ac	sae_13441

safety_text

Mechanical and environmental data

Degree of protection*	ip50
-----------------------	------

Operating temperature	40_120_c
-----------------------	----------

Mating cycles	5000
---------------	------

mated_unmated

Material and surface treatments

Housing	m_chrome
---------	----------

Contact	cu_alloy_gold
---------	---------------

safety_text_2

ul_text

illustrative_text