

Jupiter SL869 EVK User Guide

1W0301004 Rev.3 - 2013-04-18



APPLICABILITY TABLE

PRODUCT
SL869



SPECIFICATIONS SUBJECT TO CHANGE WITHOUT NOTICE

Notice

While reasonable efforts have been made to assure the accuracy of this document, Telit assumes no liability resulting from any inaccuracies or omissions in this document, or from use of the information obtained herein. The information in this document has been carefully checked and is believed to be entirely reliable. However, no responsibility is assumed for inaccuracies or omissions. Telit reserves the right to make changes to any products described herein and reserves the right to revise this document and to make changes from time to time in content hereof with no obligation to notify any person of revisions or changes. Telit does not assume any liability arising out of the application or use of any product, software, or circuit described herein; neither does it convey license under its patent rights or the rights of others.

It is possible that this publication may contain references to, or information about Telit products (machines and programs), programming, or services that are not announced in your country. Such references or information must not be construed to mean that Telit intends to announce such Telit products, programming, or services in your country.

Copyrights

This instruction manual and the Telit products described in this instruction manual may be, include or describe copyrighted Telit material, such as computer programs stored in semiconductor memories or other media. Laws in the Italy and other countries preserve for Telit and its licensors certain exclusive rights for copyrighted material, including the exclusive right to copy, reproduce in any form, distribute and make derivative works of the copyrighted material. Accordingly, any copyrighted material of Telit and its licensors contained herein or in the Telit products described in this instruction manual may not be copied, reproduced, distributed, merged or modified in any manner without the express written permission of Telit. Furthermore, the purchase of Telit products shall not be deemed to grant either directly or by implication, estoppel, or otherwise, any license under the copyrights, patents or patent applications of Telit, as arises by operation of law in the sale of a product.

Computer Software Copyrights

The Telit and 3rd Party supplied Software (SW) products described in this instruction manual may include copyrighted Telit and other 3rd Party supplied computer programs stored in semiconductor memories or other media. Laws in the Italy and other countries preserve for Telit and other 3rd Party supplied SW certain exclusive rights for copyrighted computer programs, including the exclusive right to copy or reproduce in any form the copyrighted computer program. Accordingly, any copyrighted Telit or other 3rd Party supplied SW computer programs contained in the Telit products described in this instruction manual may not be copied (reverse engineered) or reproduced in any manner without the express written permission of Telit or the 3rd Party SW supplier. Furthermore, the purchase of Telit products shall not be deemed to grant either directly or by implication, estoppel, or otherwise, any license under the copyrights, patents or patent applications of Telit or other 3rd Party supplied SW, except for the normal non-exclusive, royalty free license to use that arises by operation of law in the sale of a product.



Usage and Disclosure Restrictions

License Agreements

The software described in this document is the property of Telit and its licensors. It is furnished by express license agreement only and may be used only in accordance with the terms of such an agreement.

Copyrighted Materials

Software and documentation are copyrighted materials. Making unauthorized copies is prohibited by law. No part of the software or documentation may be reproduced, transmitted, transcribed, stored in a retrieval system, or translated into any language or computer language, in any form or by any means, without prior written permission of Telit

High Risk Materials

Components, units, or third-party products used in the product described herein are NOT fault-tolerant and are NOT designed, manufactured, or intended for use as on-line control equipment in the following hazardous environments requiring fail-safe controls: the operation of Nuclear Facilities, Aircraft Navigation or Aircraft Communication Systems, Air Traffic Control, Life Support, or Weapons Systems (High Risk Activities"). Telit and its supplier(s) specifically disclaim any expressed or implied warranty of fitness for such High Risk Activities.

Trademarks

TELIT and the Stylized T Logo are registered in Trademark Office. All other product or service names are the property of their respective owners.

Copyright © Telit Communications S.p.A. 2012.



Contents

1.	Introduction	7
1.1.	Scope	7
1.2.	Audience	7
1.3.	Contact Information, Support.....	7
1.4.	Text Conventions	8
1.5.	Related Documents	8
2.	Preparing for the SL869 EVK.....	9
2.1.	What is Necessary.....	9
2.1.1.	Installing the USB Drivers.....	9
3.	SL869 Evaluation Kit	10
3.1.	What’s in the Box.....	10
3.2.	Jupiter Evaluation Board.....	11
4.	Step-by-Step: First Time Running the SL869 Evaluation Board.....	12
4.1.	Step-by-Step: First Time Connection	12
5.	TelitView	13
5.1.	Main Interface.....	13
5.2.	Connecting to the EVK.....	13
5.2.1.	Main Menu Bar	13
5.2.2.	Main Tool Bar	13
5.2.3.	‘Connect to GPS’ Window	14
5.3.	TelitView Tabular View	14
5.3.1.	Front Panel Status	15
5.3.2.	Scatter Plot.....	15
5.3.3.	NMEA Monitor	16
5.4.	User Menu Commands Manager	16
6.	Flashing Firmware with X-Loader	17
6.1.	Flashing Requirements.....	17
6.2.	Flashing Instructions.....	17



- 7. **Communication Interface** 18
 - 7.1. **Commands**..... 18
 - 7.2. **Messages Description** 18
 - 7.3. **Commands Description**..... 19
- 8. **Evaluation Kit Schematic** 20
- 9. **Document History** 21



1. Introduction

1.1. Scope

Scope of this document is to give an overview of the Evaluation kit of the GPS/GLONASS standalone module SL869

1.2. Audience

This document is intended for customers who are evaluating one or more products in the applicability table.

1.3. Contact Information, Support

For general contact, technical support, to report documentation errors and to order manuals, contact Telit Technical Support Center (TTSC) at:

TS-EMEA@telit.com
TS-NORTHAMERICA@telit.com

Alternatively, use:

<http://www.telit.com/en/products/technical-support-center/contact.php>

For detailed information about where you can buy the Telit modules or for recommendations on accessories and components visit:

<http://www.telit.com>

To register for product news and announcements or for product questions contact Telit Technical Support Center (TTSC).

Our aim is to make this guide as helpful as possible. Keep us informed of your comments and suggestions for improvements.

Telit appreciates feedback from the users of our information.



1.4. Text Conventions



Danger – This information MUST be followed or catastrophic equipment failure or bodily injury may occur.



Caution or Warning – Alerts the user to important points about integrating the module, if these points are not followed, the module and end user equipment may fail or malfunction.



Tip or Information – Provides advice and suggestions that may be useful when integrating the module.

All dates are in ISO 8601 format, i.e. YYYY-MM-DD.

1.5. Related Documents

- Telit_Jupiter_SL869_Product_Description
- Telit_SL869_Software User_Guide



NOTE:

- **To prevent ESD and EOS damage, a properly grounded ESD wrist strap should be worn when working inside the EVK**
- **Do not alter shunt connectors while USB power is applied**
- **Do not short the RF signal to ground if antenna voltage is installed. Damage to the EVK may occur.**

Always follow ESD safety precautions when utilizing the SL869 evaluation kit. For additional information on the SL869, ask your local sales representative for additional documentation.



2. Preparing for the SL869 EVK

2.1. What is Necessary

To use the SL869 EVK, you will need:

1. FTDI USB Drivers
2. TelitView v3.0 Build 1008
3. A PC with a USB port that fulfills the minimum software requirements
 - Windows XP or above
 - .NET Framework 2.0
4. A programmed/flashed SL869 EVK
 - V3.1.3.1

2.1.1. Installing the USB Drivers

Before connecting the SL869 EVK, install the necessary USB drivers

1. Double-click the USB driver executable and follow the onscreen directions for installation.



3. SL869 Evaluation Kit

3.1. What's in the Box

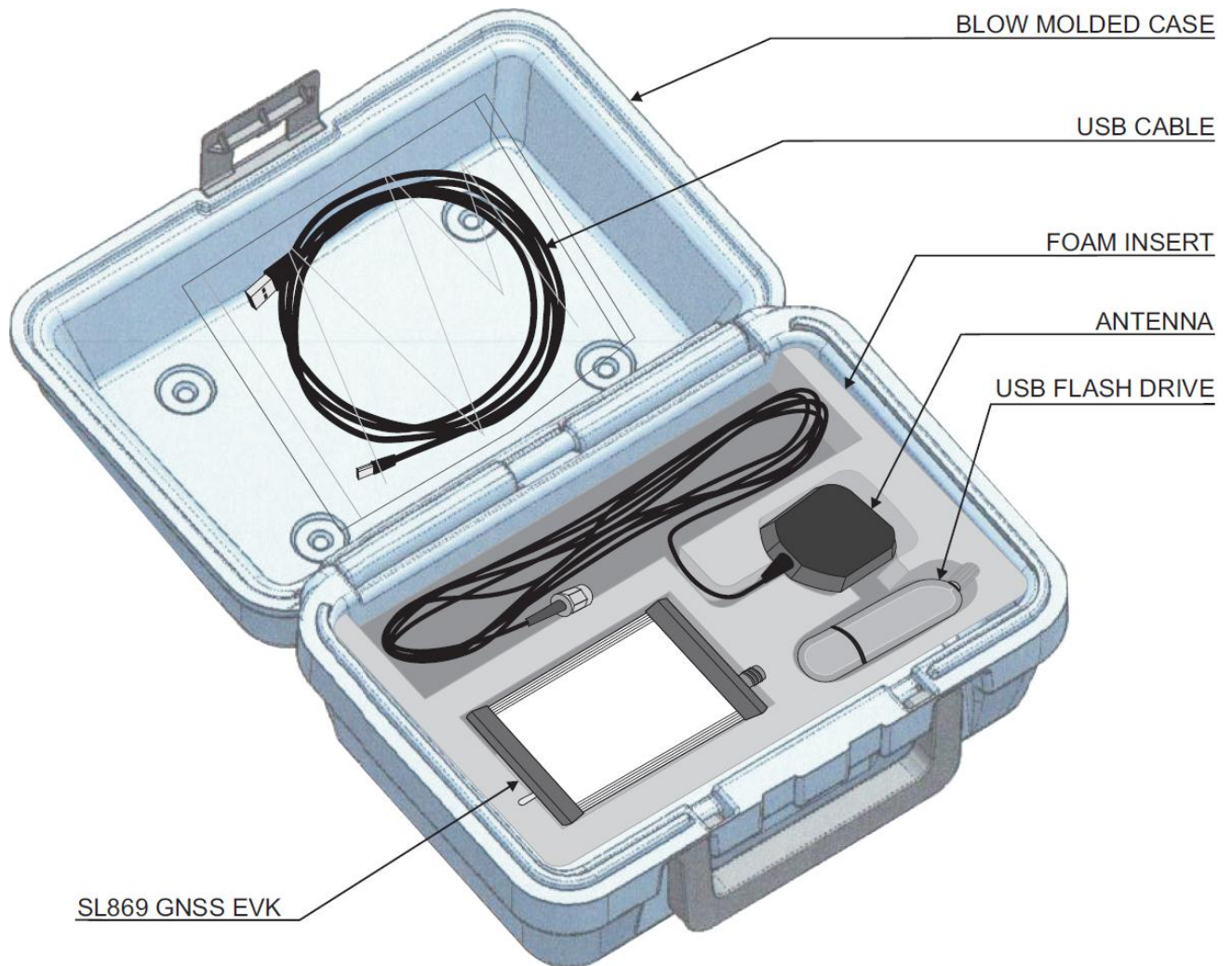

Figure 1 Box Contents



3.2. Jupiter Evaluation Board

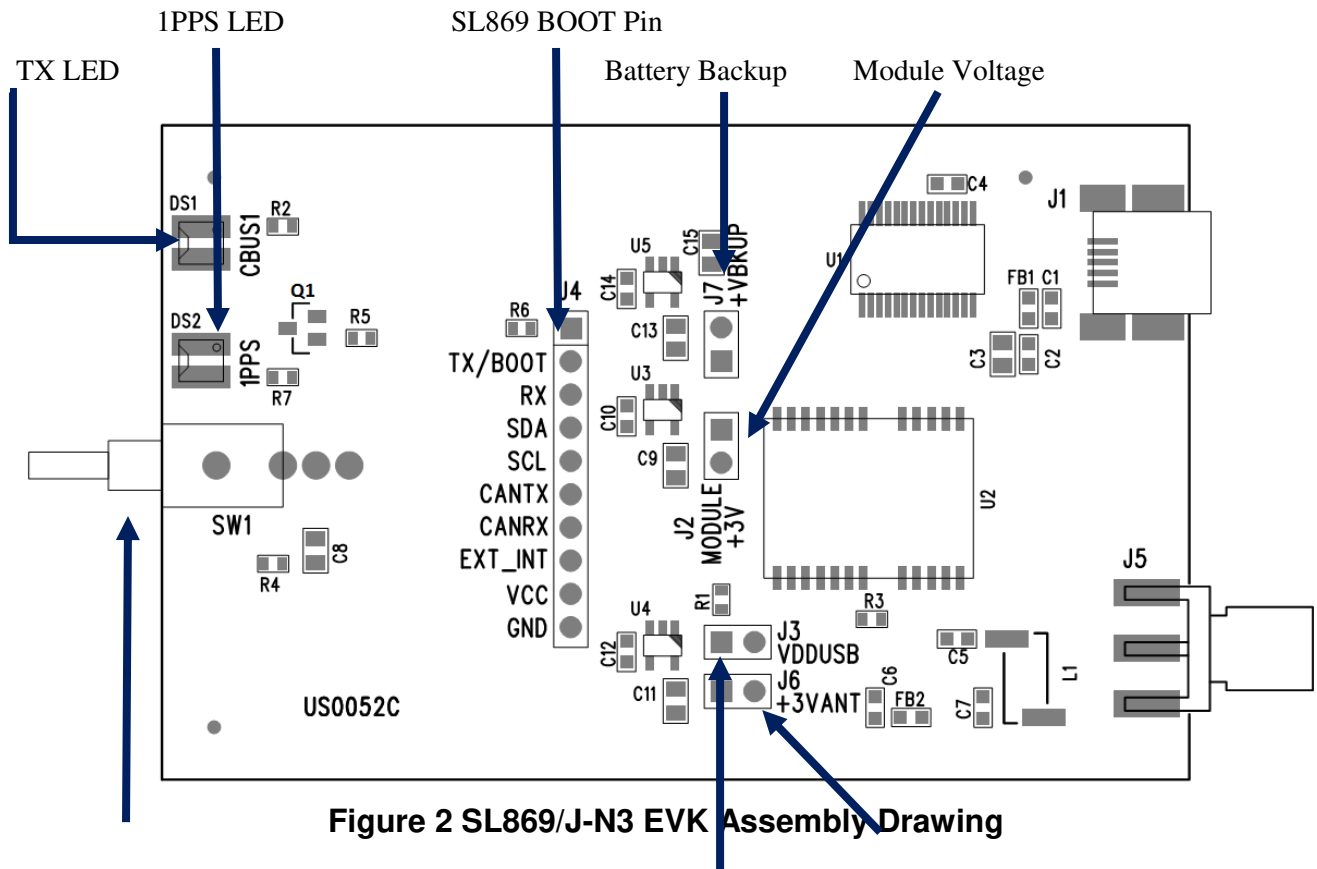

Figure 2 SL869/J-N3 EVK Assembly Drawing

ON Switch

3.3V Antenna Supply

J-N3 BOOT PIN

ITEM	FUNCTION
TX LED	LED that is tied to the USB to UART bridge RX line. The LED blinks whenever it receives data from the module.
1PPS LED	LED that displays the 1PPS output of the module
ON SWITCH	Applies power to the EVK
SL869 BOOT PIN	Place a shunt jumper on PIN 1 and the TX/BOOT of the strip before power application to place the SL869 module into BOOT mode.
BATTERY BACKUP	Place a shunt jumper to enable application of Battery Backup 3.3V
MODULE VOLTAGE	Place a shunt jumper to enable application of 3.3V to the module. Do not remove.
VDDUSB	Place a shunt jumper before power application to put J-N3 to BOOT mode.
+3VANT	Place a shunt jumper to apply 3.3V to an external active antenna.



4. Step-by-Step: First Time Running the SL869 Evaluation Board

4.1. Step-by-Step: First Time Connection

1. Before connecting the evaluation board, ensure that the USB drivers are installed.
2. Ensure that jumpers are installed on **J2**, **J6**, and **J7**.
3. Ensure that there are no jumpers installed on **J3** and **J4**.
4. Connect the provided Active Antenna to the SMA connector.
5. As soon as the evaluation board is connected to the PC, it will be detected and installed.



Figure 3 USB installation, select "Continue Anyway" to proceed

6. After the evaluation board has been installed, check the "Device Manager" window for the evaluation board COM port number. This information is needed for use with the GPS tools.
7. Turn the switch vertically UP to turn On the EVK.
8. Refer to Chapter 5 for using the EVK with software.



NOTE:

On some occasions, Windows will install a "Microsoft Serial BallPoint mouse after connecting the USB. Uninstall the Microsoft Serial BallPoint mouse if Windows mistakenly installs it.

5. TelitView

Launch the TelitView application



5.1. Main Interface

After launching TelitView, first notice the application's main interface.

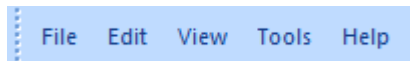

Figure 4 Main Menu Bar



Figure 5 Main Tool Bar

5.2. Connecting to the EVK

5.2.1. Main Menu Bar

Under the “Tools” option on the *Main Menu Bar*, select “Connect to GPS.” This will open the ‘Connect to GPS’ window.

5.2.2. Main Tool Bar

Select the “Connect to GPS” icon under the *Main Tool Bar* and the ‘Connect to GPS’ window will open.



5.2.3. 'Connect to GPS' Window

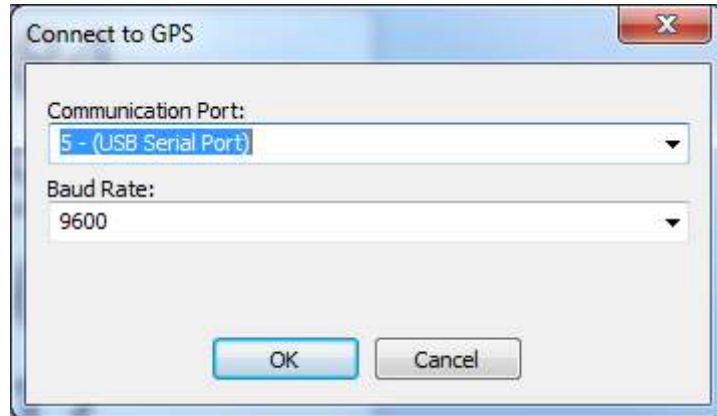

Figure 6 Connect to GPS Window

1. Select the correct Communication Port
2. Select the correct baud rate (default – 9600 SL869)

5.3. TelitView Tabular View

TelitView implements a tabular view. Switching between tabs displays different information parsed from the receiver.

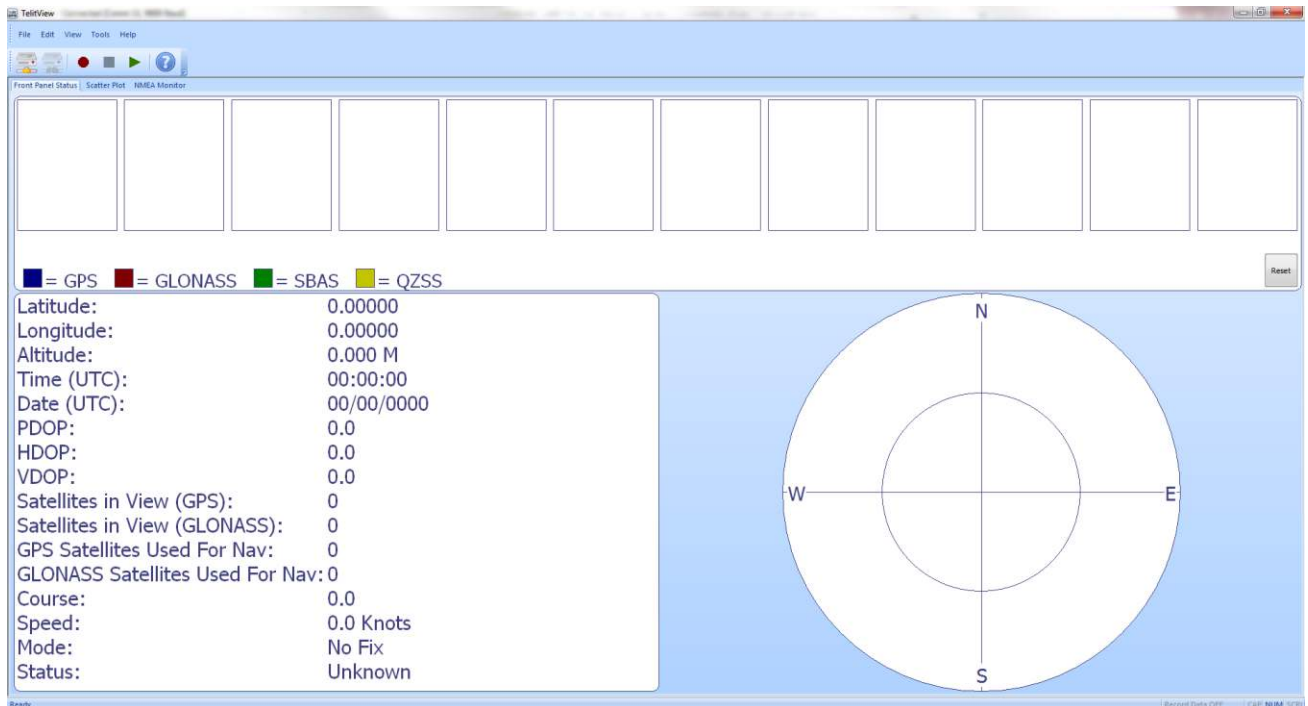

Figure 7 TelitView Application



5.3.1. Front Panel Status

The Front Panel Status Tab displays satellite information as well as position information.

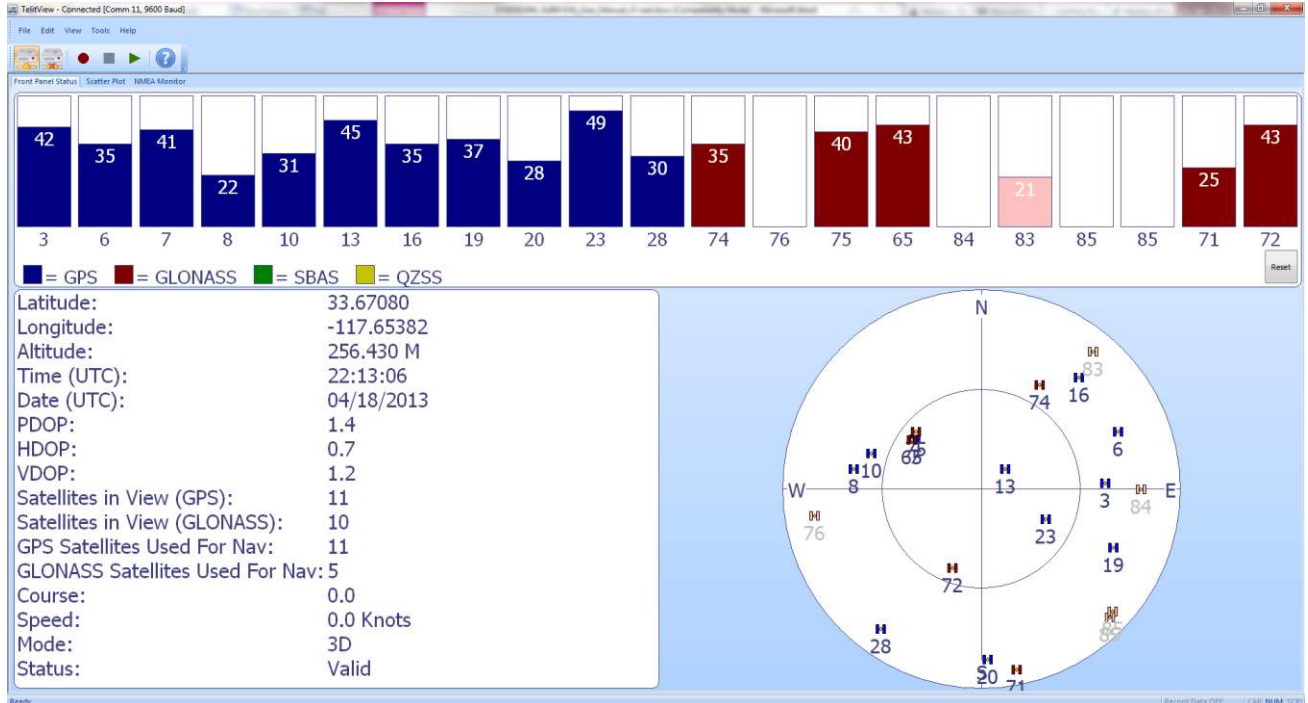

Figure 8 Front Panel Status Tab

5.3.2. Scatter Plot

The Scatter Plot displays position points that are updated every second. The position points are compared to each other in an axis in meters.

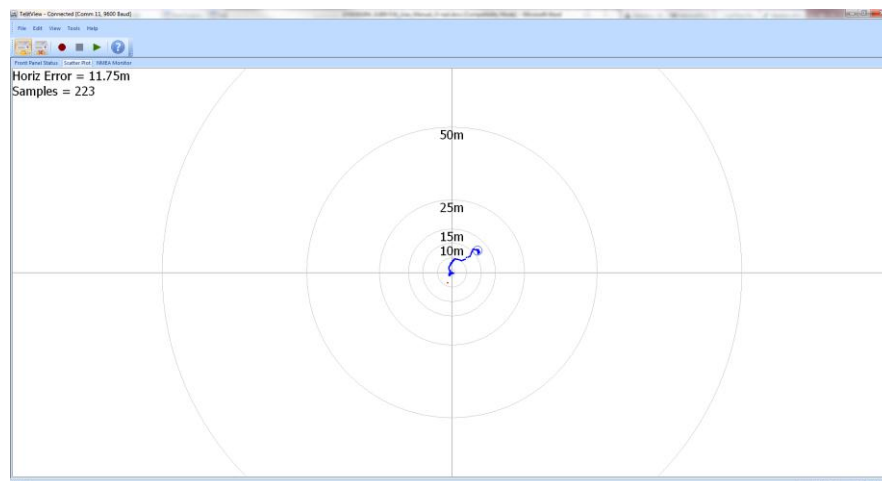

Figure 9 Scatter Plot



5.3.3. NMEA Monitor

The NMEA Monitor displays the NMEA output of the receiver. The user can also type in commands in the Transmit toolbar.

TelitView automatically adds a checksum to the command being sent.

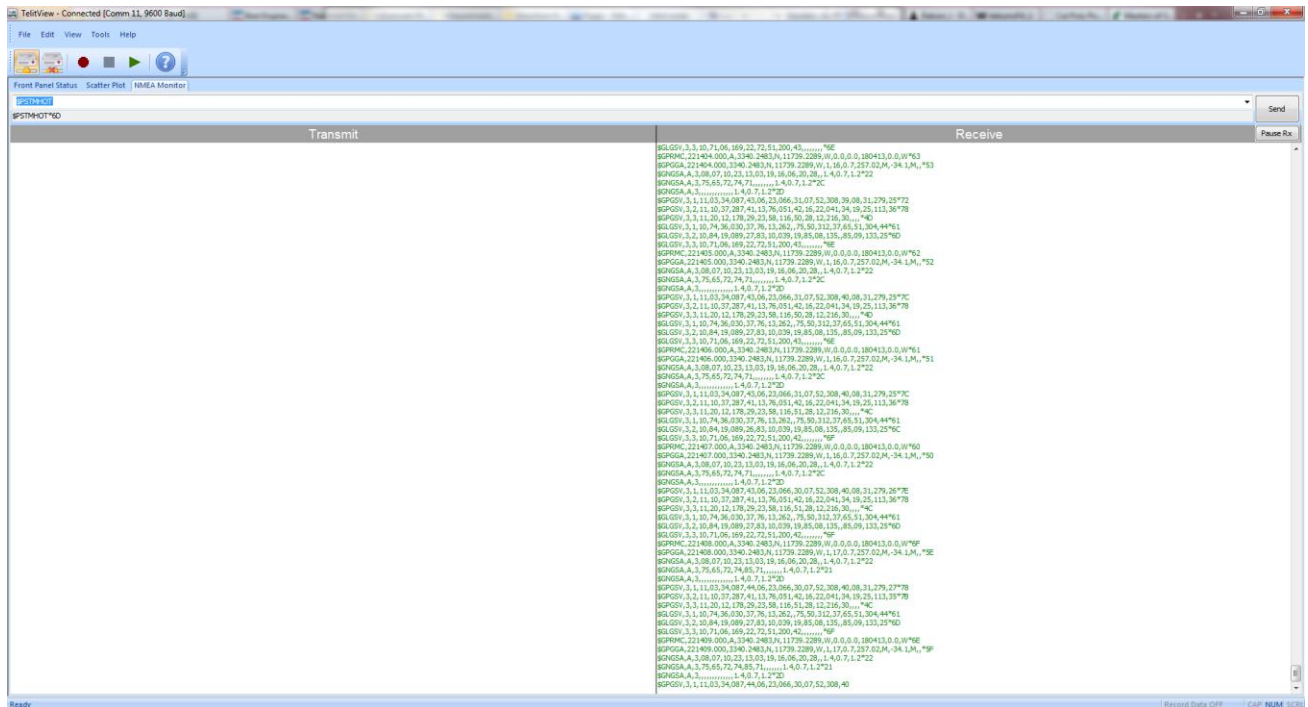

Figure 10 NMEA Monitor Tab

5.4. User Menu Commands Manager

The TelitView user has the option to enter in custom commands through the “User Menu Command Manager.” There are 10 available slots for custom commands. Each slot requires a ‘Menu Caption’ and ‘NMEA Command.’

The User Menu Command Manager is accessible through the “Tools” selection on the **Main Menu Bar**.

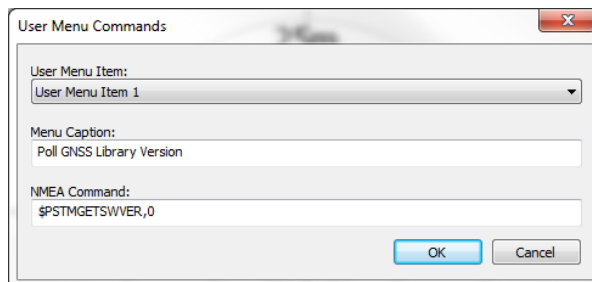

Figure 11 User Menu Command Manager



6. Flashing Firmware with X-Loader

6.1. Flashing Requirements

- V2.0.0.1 and up software from TELIT
- TeseoII X-Loader v1.71 from TELIT

6.2. Flashing Instructions

1. Install a shunt connector on Pin 1 of J4 and TX/BOOT (Pin2) of J4, tying both pins together.
2. Connect the USB connector and let the Host PC machine enumerate the USB connection.
3. Enable SW1 to the upward state to power the SL869 receiver.
4. Launch the TESEOII X-Loader and set the selections as shown in Figure 11.

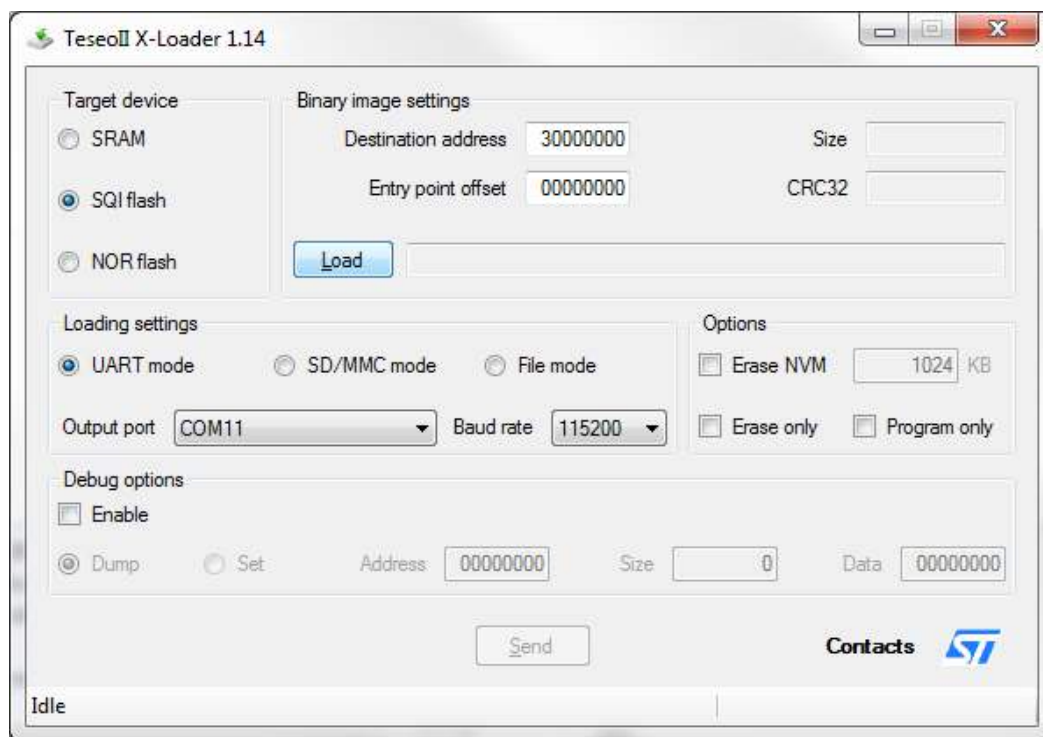

Figure 12 X-Loader

5. Click on the Load button then locate and select the provided software by Telit
6. After selecting the correct Output port for the connected receiver (Look under Device Manager for possible COM connection), click on Send to program the device.



7. Communication Interface

The SL869 offers several ways of communication between itself and the host processor. For simplicity in this document, the interface described in the examples is in UART mode.

7.1. Commands

A command is a defined Data Packet sent from a host processor to the GPS-Baseband Controller. The regular structure of the command is

```
command-ID[, <parameters>] <cr><lf>
```

Parameters, if present, are delimited by “,” characters as per the NMEA protocol. All SL869 commands are proprietary and therefore all command-ID’s begin with the “\$PSTM” character sequence.

The user interaction with the EVK can be achieved through the use of a PC terminal emulator program that is connected to the appropriate COM port with settings of:

- 9600 Baud
- 0 Parity Bits
- 1 Stop Bit
- 8 Data Bit

7.2. Messages Description

The table below summarizes the periodic output messages of the SL869:

Message ID	Description
\$GPGGA	NMEA: Global Position System fix data
\$GNGSA	NMEA: GNSS Dilution of Precision (DOP) and active satellites
\$--GSV	NMEA: GNSS satellites in view. “GP” talker ID reports GPS, “GL” talker ID reports GLONASS satellites.
\$GPRMC	NMEA: Recommended minimum specific GNSS data

All messages are output once per second. There are multiple GSA and GSV messages output each second.



7.3. Commands Description

The table below summarizes the set of commands for the SL869:

Command ID	Description
\$PSTMINITGPS	Initialize GPS position and time
\$PSTMCLREPHS	Clear all ephemeris data
\$PSTMDUMPEPHEMS	Dump ephemeris data
\$PSTMEPH	Load ephemeris data
\$PSTMNMEAONOFF	Toggle the NMEA output ON and OFF
\$PSTMCOLD	Perform a COLD start
\$PSTMWARM	Perform a WARM start
\$PSTMHOT	Perform a HOT start
\$PSTMSRR	Perform a system reset
\$PSTMGPSRESET	Reset the GPS engine
\$PSTM2DFIXONOFF	Enable/disable 2-D acquisition fixes
\$PSTMGETSWVER	Get the GNSS Library version
\$PSTMSBASONOFF	Toggle the SBAS feature ON and OFF
\$PSTMSTAGPSONOFF	Enable/disable the STAGPS engine
\$PSTMSETCONSTMASK	Set the GNSS constellation mask

Unless otherwise noted in the SL869 SW User Guide document, commands are echoed by the SL869 after the command is executed.



8. Evaluation Kit Schematic

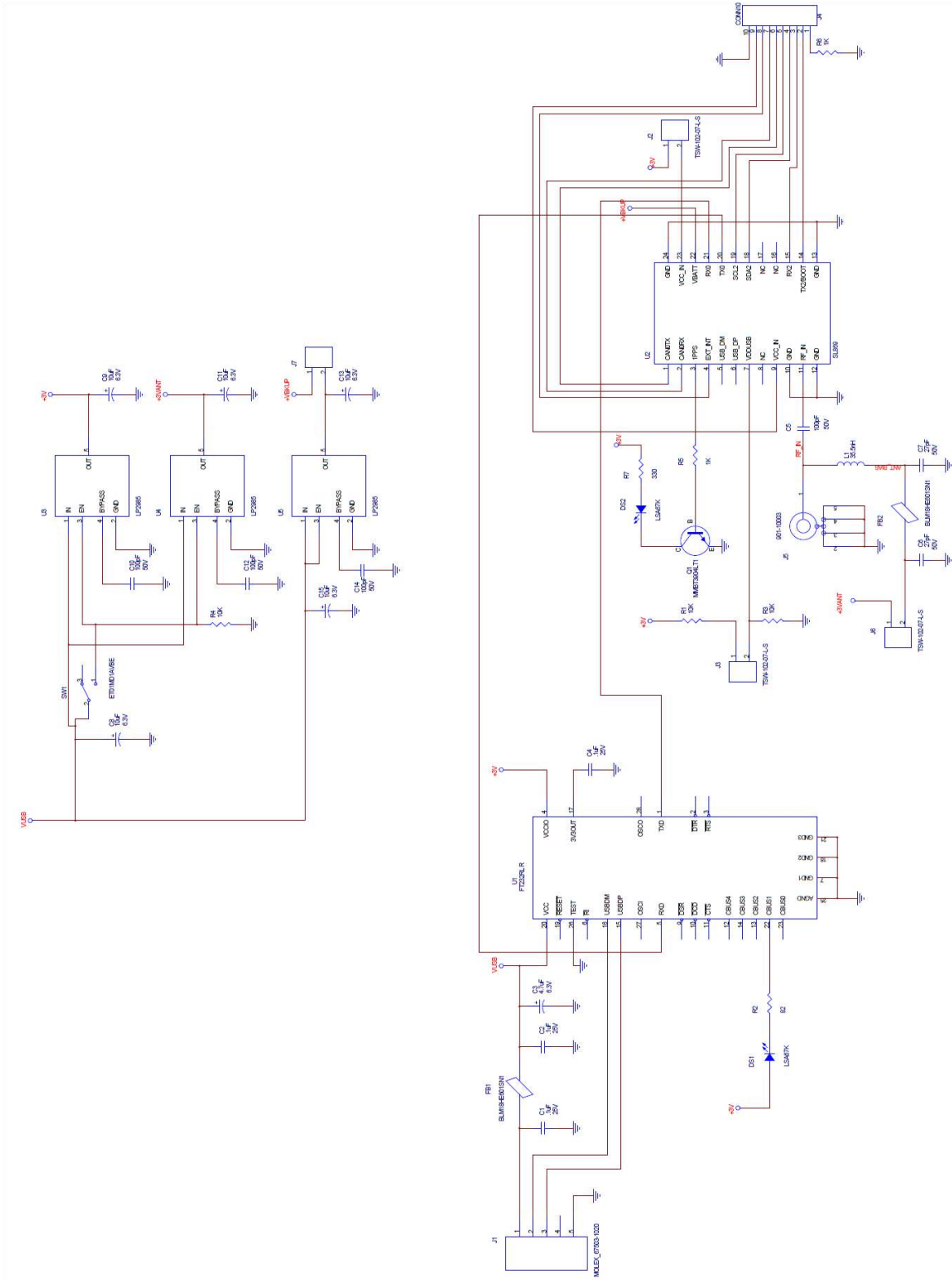

9. Document History

Revision	Date	Changes
0	2012-03-22	Draft issue
1	2012-04-02	Add Flashing and Messaging sections
2	2012-06-11	Updated TelitView section for v2.0 Build 1001
3	2013-04-18	Updated TelitView section for v3.0 Build 1008, update Section 7.3, and add EVK schematics.

