

## DESCRIPTION

The MPQ2490 is a monolithic step-down switch mode converter with programmable output current limit. It achieves 1.5A continuous output current over a wide input supply range with excellent load and line regulation.

The maximum output current can be programmed by sensing current through the inductor DC resistance (DCR) or an accurate sense resistor.

Fault condition protection includes cycle-by-cycle current limiting and thermal shutdown.

The MPQ2490 requires a minimum number of readily available standard external components. The MPQ2490 is available in QFN (3x 3mm) package.

## FEATURES

- Wide 4.5V to 36V Operating Input Range
- Programmable up to 1.5A Output Current
- Output Adjustable from 0.8V to 15V
- Programmable Output Current Limit without power loss
- 0.25Ω Internal Power MOSFET Switch
- Stable with Low ESR Output Ceramic Capacitors
- 95% Efficiency @ 500mA (Vo=5V)
- Fixed 700kHz Frequency
- Thermal Shutdown
- Cycle-by-Cycle Over Current Protection
- Available in QFN10 Package

## APPLICATIONS

- Industrial and Car Power Supplies
- USB Power Supplies
- Automotive Cigarette Lighter Adapters
- Power Supply for Battery Chargers

All MPS parts are lead-free, halogen free, and adhere to the RoHS directive. For MPS green status, please visit MPS website under Quality Assurance.  
"MPS" and "The Future of Analog IC Technology" are Registered Trademarks of Monolithic Power Systems, Inc.

## TYPICAL APPLICATION

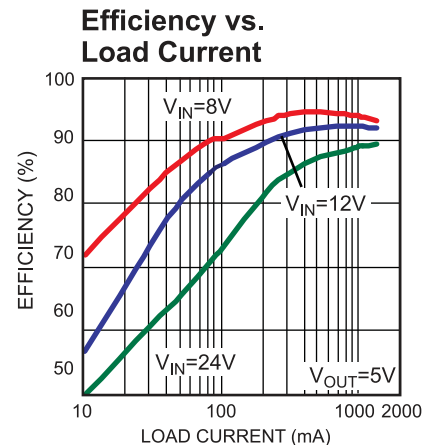
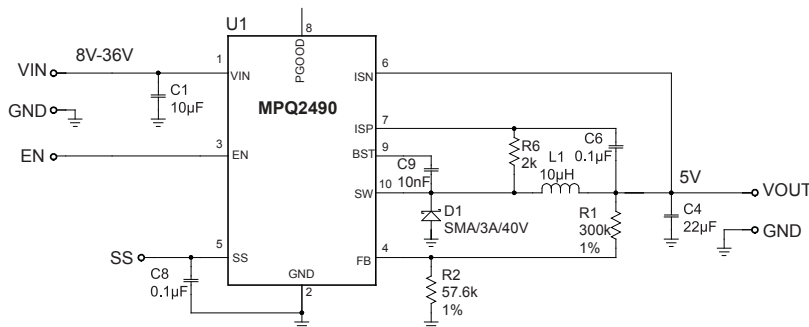

## ORDERING INFORMATION

Part Number	Package	Top Marking	Free-Air Temperature (T <sub>A</sub> )
MPQ2490DQ	QFN10 (3mm x 3mm)	T6	-40°C to +85°C

\* For Tape & Reel, add suffix -Z (e.g. MPQ2490DQ-Z);  
 For RoHS compliant packaging, add suffix -LF; (e.g. MPQ2490DQ-LF-Z)

## PACKAGE REFERENCE

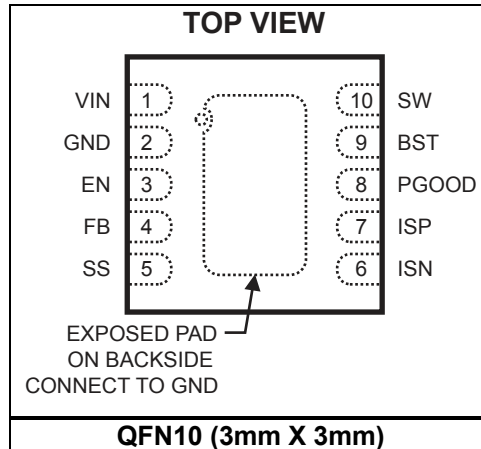

### ABSOLUTE MAXIMUM RATINGS <sup>(1)</sup>

Supply Voltage V <sub>IN</sub> .....	40V
V <sub>SW</sub> .....	-0.3V to V <sub>IN</sub> + 0.3V
V <sub>BST</sub> .....	V <sub>SW</sub> + 6.5V
V <sub>ISN</sub> , V <sub>ISP</sub> .....	0V to 15V
All Other Pins .....	-0.3V to +6.5V
Junction Temperature .....	150°C
Continuous Power Dissipation (T <sub>A</sub> = +25°C) <sup>(2)</sup>	
QFN10 (3mm x 3mm) .....	2.5W
Lead Temperature .....	260°C
Storage Temperature .....	-65°C to +150°C

### Recommended Operating Conditions <sup>(3)</sup>

Supply Voltage V <sub>IN</sub> .....	4.5V to 36V
Output Voltage V <sub>OUT</sub> (V <sub>IN</sub> >16.5V) .....	0.8V to 15V
Output Voltage V <sub>OUT</sub> (V <sub>IN</sub> ≤16.5V) .....	
.....	0.8V to (V <sub>IN</sub> -1.5) V
Operating Junction Temp. (T <sub>J</sub> ) .....	-40°C to +125°C

Thermal Resistance <sup>(4)</sup>	θ <sub>JA</sub>	θ <sub>JC</sub>
QFN10 (3mm x 3mm) .....	50	12 ... °C/W

#### Notes:

- Exceeding these ratings may damage the device.
- The maximum allowable power dissipation is a function of the maximum junction temperature T<sub>J</sub>(MAX), the junction-to-ambient thermal resistance θ<sub>JA</sub>, and the ambient temperature T<sub>A</sub>. The maximum allowable continuous power dissipation at any ambient temperature is calculated by P<sub>D</sub>(MAX)=(T<sub>J</sub>(MAX)-T<sub>A</sub>)/θ<sub>JA</sub>. Exceeding the maximum allowable power dissipation will cause excessive die temperature, and the regulator will go into thermal shutdown. Internal thermal shutdown circuitry protects the device from permanent damage.
- The device is not guaranteed to function outside of its operating conditions.
- Measured on approximately 1" square of 1 oz copper.

## ELECTRICAL CHARACTERISTICS

$V_{IN} = 12V$ ,  $T_A = -40^{\circ}C$  to  $+85^{\circ}C$ . Typical values are at  $T_A=25^{\circ}C$ , unless otherwise noted.

Parameters	Symbol	Condition	Min	Typ	Max	Units	
Feedback Voltage	$V_{FB}$	$4.5V \leq V_{IN} \leq 36V$	$T_A=25^{\circ}C$	0.785	0.805	0.825	V
			$-40^{\circ}C \leq T_A \leq 85^{\circ}C$	0.777		0.833	
Feedback Bias Current	$I_{BIAS(FB)}$	$V_{FB} = 0.8V$		0.01	1	$\mu A$	
Switch On Resistance	$R_{DS(ON)}$			0.25		$\Omega$	
Switch Leakage		$V_{EN} = 0V, V_{SW} = 0V$		0.1	10	$\mu A$	
Current Limit <sup>(5)</sup>		Duty Cycle $\leq 80\%$	1.7		4.2	A	
Oscillator Frequency	$f_{SW}$	$V_{FB} = 0.6V$	500	700	950	kHz	
Fold-Back Frequency		$V_{FB} = 0V$		200		kHz	
Boot-Strap Voltage	$V_{BST} - V_{SW}$			5		V	
Minimum On Time <sup>(5)</sup>	$t_{ON}$	$V_{FB} = 1V$		100		ns	
Under Voltage Lockout Threshold Rising			2.9	3.3	3.7	V	
Under Voltage Lockout Threshold Hysteresis				200		mV	
Supply Current (Shutdown)		$V_{EN} = 0V$		4	25	$\mu A$	
Supply Current (Quiescent)		$V_{EN} = 2V, V_{FB} = 1V$		500	800	$\mu A$	
Thermal Shutdown <sup>(5)</sup>				150		$^{\circ}C$	
Current Sense Voltage	$V_{ISP} - V_{ISN}$	$V_{ISP}, V_{ISN} \quad 0.4-15V$	80	100	120	mV	
Input Bias Current (ISN, ISP)	$I_{BIAS (ISN,ISP)}$	$V_{ISP}, V_{ISN} \quad 0.4-15V$	-1.5	0.1	+1.5	$\mu A$	

**Note:**

5) Derived from design and bench characterization. Not tested in production.

## PIN FUNCTIONS

QFN10 Pin #	Name	Description
1	VIN	Supply Voltage. The MPQ2490 operates from a +4.5V to +36V unregulated input. $C_{IN}$ is needed to prevent large voltage spikes from appearing at the input. Put $C_{IN}$ as close to the IC as possible. It is the drain of the internal power device and power supply for the whole chip.
2	GND	Ground. This pin is the voltage reference for the regulated output voltage. For this reason care must be taken in its layout. This node should be placed outside of the D1 to $C_{IN}$ ground path to prevent switching current spikes from inducing voltage noise into the part.
3	EN	On/Off Control Input. (Only available for the MPQ2490DQ)
4	FB	Feedback. An external resistor divider from the output to GND, tapped to the FB pin sets the output voltage. To prevent current limit run away during a short circuit fault condition the frequency-fold-back comparator lowers the oscillator frequency when the FB voltage is below 250mV.
5	SS	Connect to an external capacitor used for Soft-Start and compensation for current limiting loop.
6	ISN	Negative Current Sense Input for load current limiting.
7	ISP	Positive Current Sense
8	PGOOD	Power good signal. When FB is less than 90% of 0.8V, PGOOD is low. It is an open-drain output. Use a high value pull-up resistor externally to pull it up to system power supply. (Only available for the MPQ2490DQ)
9	BST	Bootstrap. This capacitor is needed to drive the power switch's gate above the supply voltage. It is connected between SW and BST pins to form a floating supply across the power switch driver. An on-chip regulator is used to charge up the external boot-strap capacitor. If the on-chip regulator is not strong enough, one optional diode can be connected from IN or OUT to charge the external boot-strap capacitor.
10	SW	Switch Output. It is the source of power device.

## TYPICAL PERFORMANCE CHARACTERISTICS

C1=C2=4.7μF, C3=C4=10μF, C8=0.1μF, L=12μH, T<sub>A</sub>=25°C, unless otherwise noted

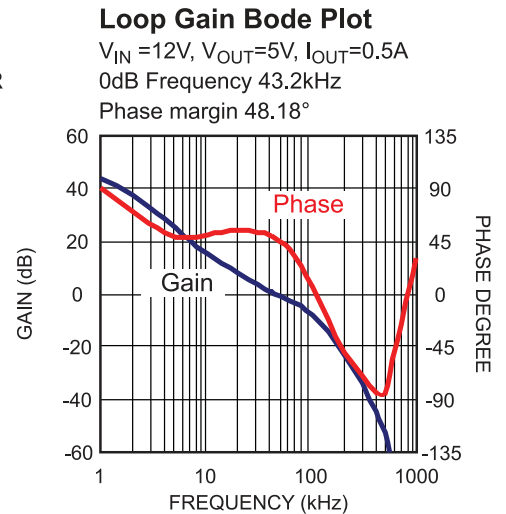
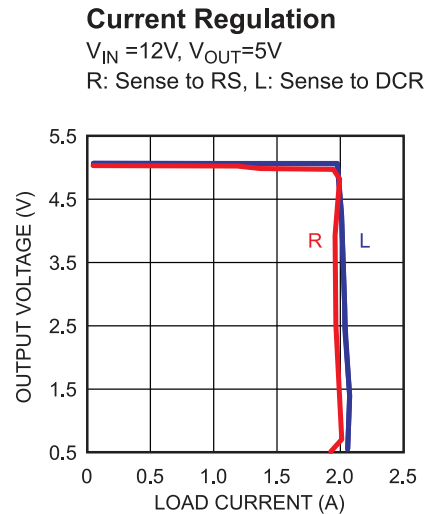
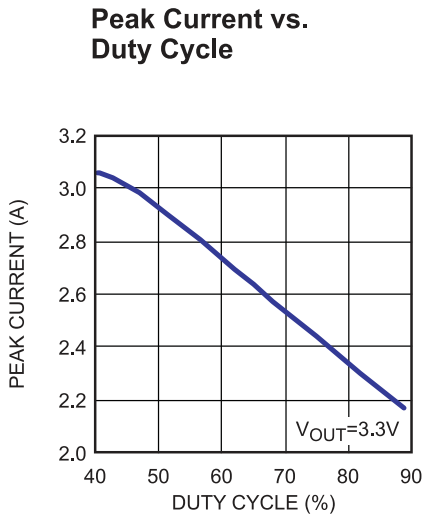
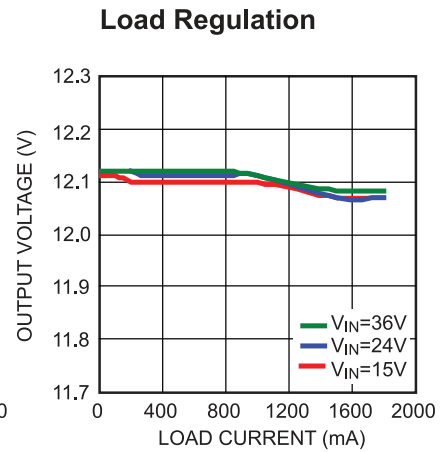
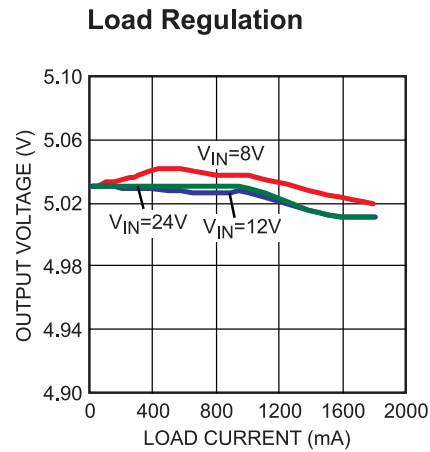
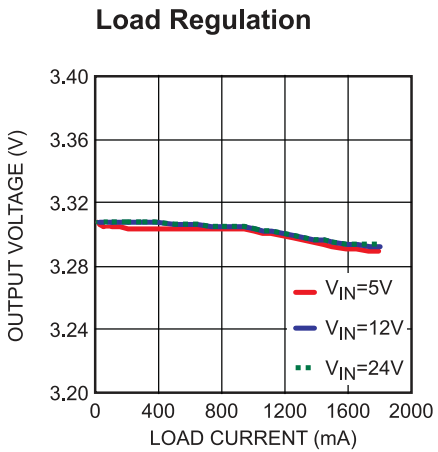
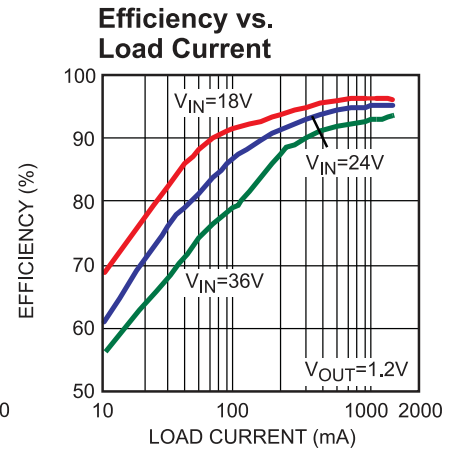
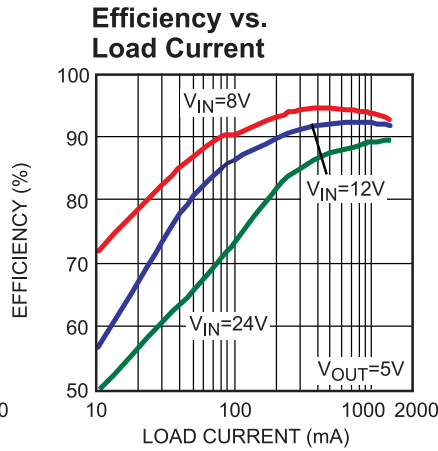
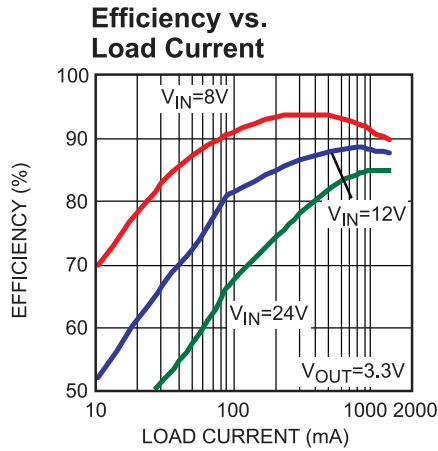

## TYPICAL PERFORMANCE CHARACTERISTICS (continued)

C1=C2=4.7 $\mu$ F, C3=C4=10 $\mu$ F, C8=0.1 $\mu$ F, L=12 $\mu$ H, T<sub>A</sub>=25°C, unless otherwise noted

### Steady State

V<sub>IN</sub>=8V, V<sub>EN</sub> put to V<sub>IN</sub>  
V<sub>OUT</sub>=5V, I<sub>OUT</sub>=1.8A, Electrical Load

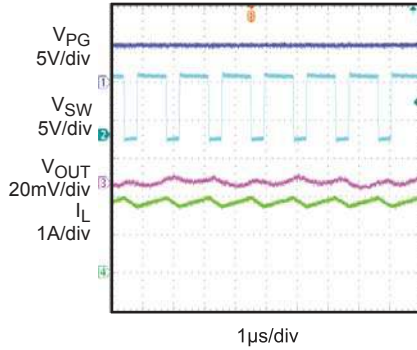

### Power Ramp Up

V<sub>IN</sub>=12V, V<sub>EN</sub> put to V<sub>IN</sub>  
V<sub>OUT</sub>=5V, I<sub>OUT</sub>=130mA, Resistor Load

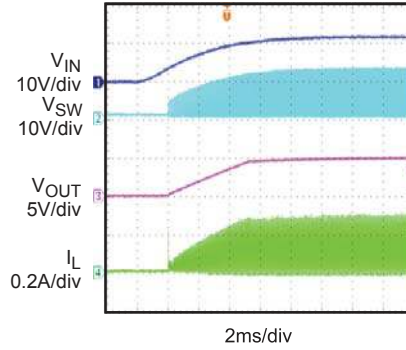

### Power Ramp Down

V<sub>IN</sub>=12V, V<sub>EN</sub> put to V<sub>IN</sub>  
V<sub>OUT</sub>=5V, I<sub>OUT</sub>=130mA, Resistor Load

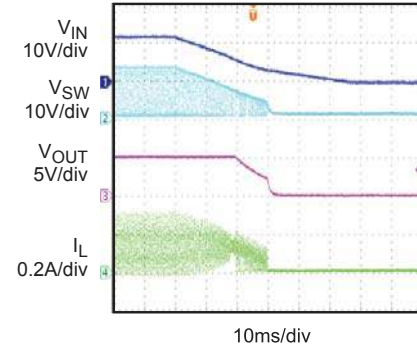

### Steady State

V<sub>IN</sub>=16V, V<sub>EN</sub> put to V<sub>IN</sub>  
V<sub>OUT</sub>=5V, I<sub>OUT</sub>=1.8A, Electrical Load

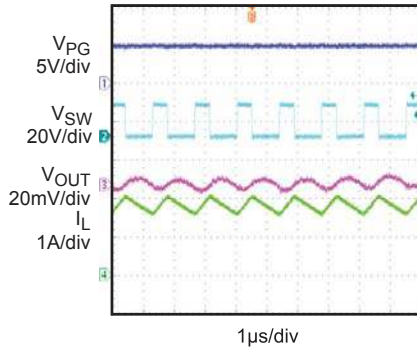

### Steady State

V<sub>IN</sub>=15V, V<sub>EN</sub> put to V<sub>IN</sub>  
V<sub>OUT</sub>=12V, I<sub>OUT</sub>=1.8A, Electrical Load

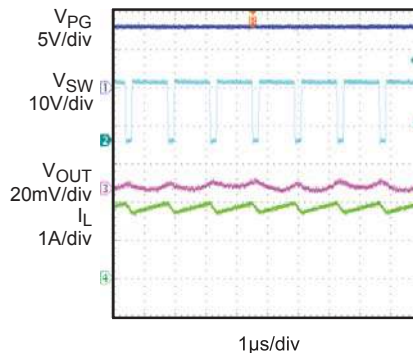

### Short Circuit

V<sub>IN</sub>=12V, V<sub>EN</sub> put to V<sub>IN</sub>  
V<sub>OUT</sub>=5V

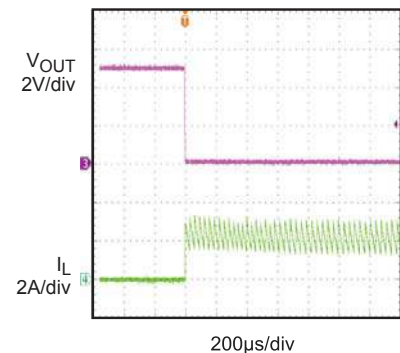

### Short Circuit Recovery

V<sub>IN</sub>=12V, V<sub>EN</sub> put to V<sub>IN</sub>  
V<sub>OUT</sub>=5V

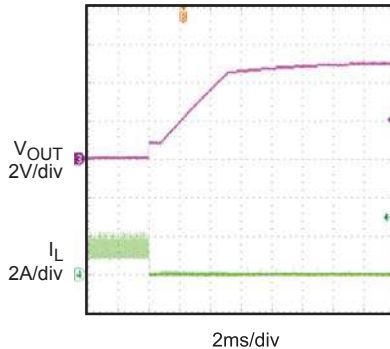

## OPERATION

### Main Control Loop

The MPQ2490 is a current mode buck regulator. That is, the error amplifier (EA) output voltage is proportional to the peak inductor current.

At the beginning of a cycle, the integrated high side power switch M1 (Fig.1) is off; the EA output voltage is higher than the current sense amplifier output; and the current comparator's output is low. The rising edge of the 700kHz clock signal sets the RS Flip-Flop. Its output turns on M1 thus connecting the SW pin and inductor to the input supply.

The increasing inductor current is sensed and amplified by the Current Sense Amplifier. Ramp compensation is added to Current Sense Amplifier output and compared to the Error Amplifier output by the PWM Comparator. When the Current Sense Amplifier plus Slope Compensation signal exceeds the EA output voltage, the RS Flip-Flop is reset and the MPQ2490 reverts to its initial M1 off state.

If the Current Sense Amplifier plus Slope Compensation signal does not exceed the COMP voltage, then the falling edge of the CLK resets the Flip-Flop.

The output of the Error Amplifier integrates the voltage difference between the feedback and the 0.8V bandgap reference. The polarity is such that a FB pin voltage lower than 0.8V increases the EA output voltage. Since the EA output voltage is proportional to the peak inductor current, an increase in its voltage increases current delivered to the output. An external Schottky Diode (D1) carries the inductor current when M1 is off.

### Load Current Limiting Loop

The output current information is sensed via the ISP and ISN pins. The regulation threshold is set at 100mV. If  $V_{SENSE}$ , the difference of  $V_{ISP}$  and  $V_{ISN}$ , is less than 100mV, the output voltage of the power supply will be set by the FB pin. If  $V_{SENSE}$  reaches 100mV, the current limit loop will pull down SS and regulate the output at a constant current determined by the external sense resistor. The external capacitor on SS pin is the dominant compensation capacitor for load current regulation loop. The capacitor has normal value of 100nF, which will put the bandwidth of load current regulation loop to be less than 1kHz. When  $V_{SENSE}$  is higher than 100mV, SS will not drop down to the final regulation level immediately. It will cause the load current to be higher than the programmed level for a short period. A fast comparator is added to shut down power switch when the average load current is higher than 120% of the programmed current limit level.

An inductor DC resistance (DCR) or accurate sense resistor can be used for load current sensing.

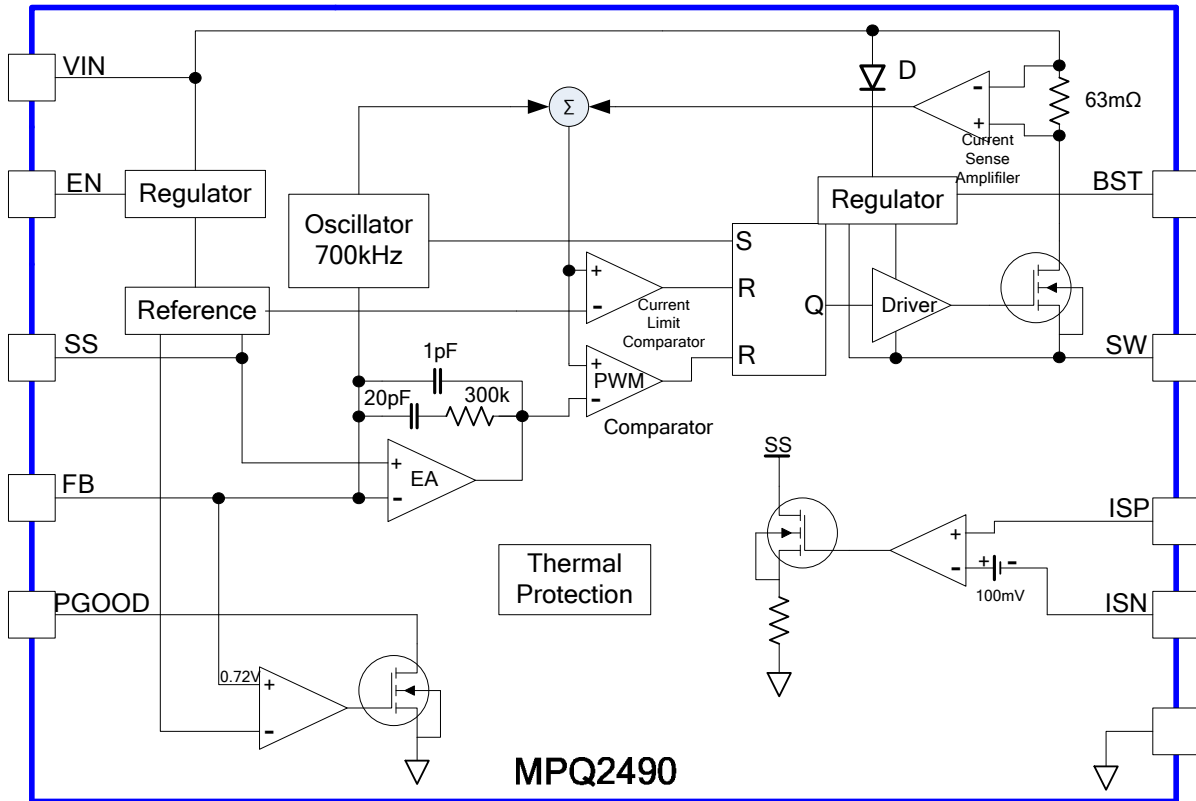

Figure 1—Functional Block Diagram



## APPLICATION INFORMATION

### Setting the Output Voltage

The external resistor divider is used to set the output voltage (see the schematic on front page). The feedback resistor R1 also sets the feedback loop bandwidth with the internal compensation capacitor (see Figure 1). Choose R1 to be around 301kΩ for optimal transient response. R2 is then given by:

$$R2 = \frac{R1}{\frac{V_{OUT}}{0.8V} - 1}$$

**Table 1—Resistor Selection for Common Output Voltages**

V <sub>OUT</sub> (V)	R1 (kΩ)	R2 (kΩ)
1.8	301 (1%)	243 (1%)
2.5	301 (1%)	140 (1%)
3.3	301 (1%)	95.3 (1%)
5	301 (1%)	57.6 (1%)

### Selecting the Inductor

A 1μH to 15μH inductor with a DC current rating of at least 25% percent higher than the maximum load current is recommended for most applications. For highest efficiency, the inductor DC resistance should be as low as possible, i.e. 150mΩ or less. For most designs, the inductance value can be derived from the following equation.

$$L = \frac{V_{OUT} \times (V_{IN} - V_{OUT})}{V_{IN} \times \Delta I_L \times f_{SW}}$$

Where  $\Delta I_L$  is the inductor ripple current.

Choose inductor current ripple to be approximately 30% of the maximum load current. The maximum inductor peak current is:

$$I_{L(MAX)} = I_{LOAD} + \frac{\Delta I_L}{2}$$

Under light load conditions below 100mA, larger inductance is recommended for improved efficiency.

### Selecting the Input Capacitor

The input capacitor reduces the surge current drawn from the input and also the switching noise from the device. The input capacitor impedance at the switching frequency should be less than the input source impedance to prevent high frequency switching current from pass to the input. Ceramic capacitors with X5R or X7R dielectrics are highly recommended because of their low ESR and small temperature coefficients. For most applications, a 4.7μF capacitor is sufficient.

### Selecting the Output Capacitor

The output capacitor keeps output voltage small and ensures regulation loop stability. The output capacitor impedance should be low at the switching frequency. Ceramic capacitors with X5R or X7R dielectrics are recommended.

### PC Board Layout

The high current paths (GND, IN and SW) should be placed very close to the device with short, direct and wide traces. The input capacitor needs to be as close as possible to the IN and GND pins. The external feedback resistors should be placed next to the FB pin. Keep the switching node SW short and away from the feedback network. ISN, ISP are sensitive nodes. Put the sensing components as close to the device as possible and keep them away from the high current and noisy paths such as GND, IN, SW). Match the trace and components on ISN, ISP paths as good as possible.

## Output Current Sensing

The output current can be sensed through the DC resistance (DCR) of the inductor, as shown in Figure 2a.

In Figure 2a, the output current limit is set as:

$$I_{OUT} = \frac{100\text{mV}}{\text{DCR}} \times \frac{R_a + R_b}{R_b}$$

Where DCR is the DC resistance of the inductor winding.

In Figure 2a, it is desirable to keep

$$\frac{R_a \cdot R_b}{R_a + R_b} \times C_s = \frac{L1}{\text{DCR}}$$

If, there is no Rb:

$$R_a \times C_s = \frac{L1}{\text{DCR}}$$

For more accurate sensing, use a more accurate sense resistor, as in Figure 2b, where the output current limit is set as:

$$I_{OUT} = \frac{100\text{mV}}{R_{SENSE}}$$

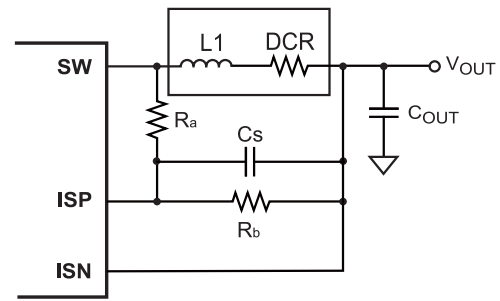

(a)

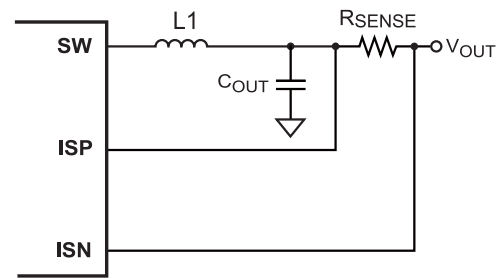

(b)

**Figure 2—Current Sensing Methods**

## PACKAGE INFORMATION

### QFN10 (3mm x 3mm)

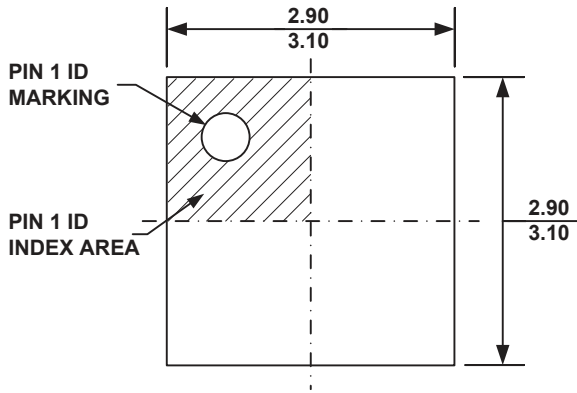

**TOP VIEW**

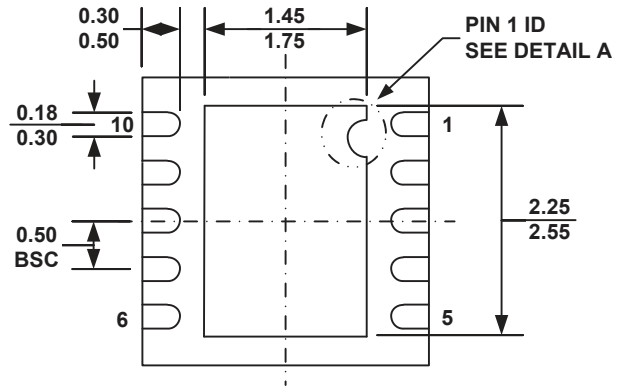

**BOTTOM VIEW**

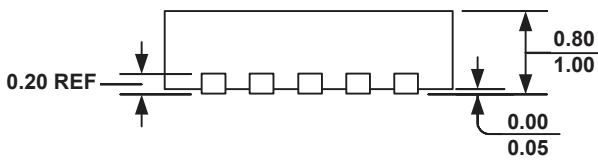

**SIDE VIEW**

**PIN 1 ID OPTION A**  
R0.20 TYP.

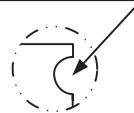

**PIN 1 ID OPTION B**  
R0.20 TYP.



**DETAIL A**

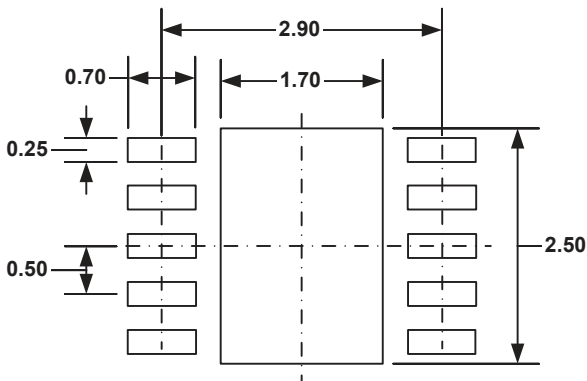

**RECOMMENDED LAND PATTERN**

#### NOTE:

- 1) ALL DIMENSIONS ARE IN MILLIMETERS.
- 2) EXPOSED PADDLE SIZE DOES NOT INCLUDE MOLD FLASH.
- 3) LEAD COPLANARITY SHALL BE 0.10 MILLIMETER MAX.
- 4) DRAWING CONFORMS TO JEDEC MO-229, VARIATION VEED-5.
- 5) DRAWING IS NOT TO SCALE.

**NOTICE:** The information in this document is subject to change without notice. Please contact MPS for current specifications. Users should warrant and guarantee that third party Intellectual Property rights are not infringed upon when integrating MPS products into any application. MPS will not assume any legal responsibility for any said applications.