

Features

- Ideal for indication light on hand held products
- Long life and robust package
- Standard Package: 2,000pcs/ Reel
- MSL (Moisture Sensitivity Level): 3
- RoHS compliant



ATTENTION
OBSERVE PRECAUTIONS
FOR HANDLING
ELECTROSTATIC
DISCHARGE
SENSITIVE
DEVICES

Package Schematics

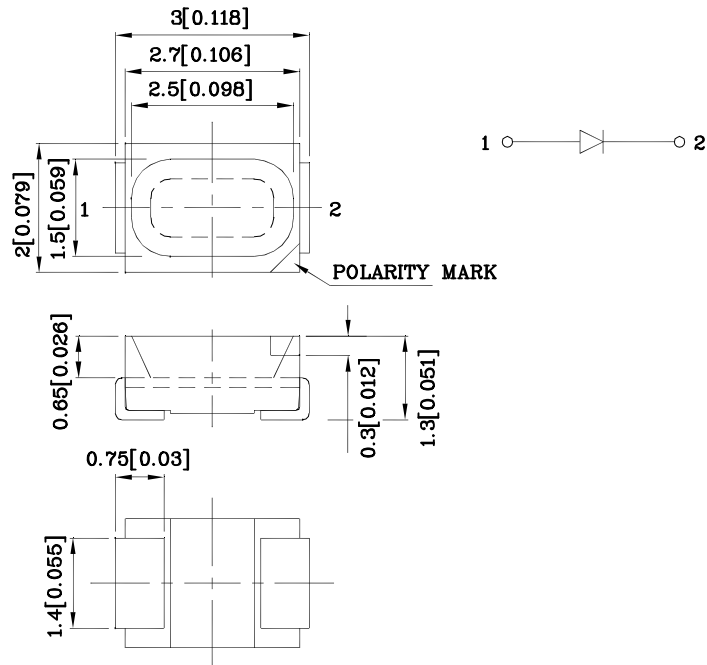

Notes:

1. All dimensions are in millimeters (inches).
2. Tolerance is ± 0.2 (0.008") unless otherwise noted.
3. Specifications are subject to change without notice.

| Absolute Maximum Ratings ($T_A=25^\circ\text{C}$) | | Orange (AlGaInP) | Unit |
|--|-----------|---------------------|------|
| Reverse Voltage | V_R | 5 | V |
| Forward Current | I_F | 30 | mA |
| Forward Current (Peak) 1/10 Duty Cycle 0.1ms Pulse Width | i_{FS} | 195 | mA |
| Power Dissipation | P_D | 75 | mW |
| Operating Temperature | T_A | -40 ~ +85 | °C |
| Storage Temperature | T_{stg} | -40 ~ +85 | |

A Relative Humidity between 40% and 60% is recommended in ESD-protected work areas to reduce static build up during assembly process (Reference JEDEC/JESD625-A and JEDEC/J-STD-033)

| Operating Characteristics ($T_A=25^\circ\text{C}$) | | Orange (AlGaInP) | Unit |
|---|-----------------|---------------------|---------------|
| Forward Voltage (Typ.) ($I_F=20\text{mA}$) | V_F | 2.1 | V |
| Forward Voltage (Max.) ($I_F=20\text{mA}$) | V_F | 2.5 | V |
| Reverse Current (Max.) ($V_R=5\text{V}$) | I_R | 10 | μA |
| Wavelength of Peak Emission CIE127-2007* (Typ.) ($I_F=20\text{mA}$) | λ_P | 610* | nm |
| Wavelength of Dominant Emission CIE127-2007* (Typ.) ($I_F=20\text{mA}$) | λ_D | 601* | nm |
| Spectral Line Full Width At Half-Maximum (Typ.) ($I_F=20\text{mA}$) | $\Delta\lambda$ | 29 | nm |
| Capacitance (Typ.) ($V_F=0\text{V}$, $f=1\text{MHz}$) | C | 15 | pF |

| Part Number | Emitting Color | Emitting Material | Lens-color | Luminous Intensity CIE127-2007* ($I_F=20\text{mA}$) mcd | | Wavelength CIE127-2007* λ_P nm | Viewing Angle 20 1/2 |
|-------------|----------------|-------------------|-------------|--|-------------|---|-------------------------|
| | | | | min. | typ. | | |
| XZMOK105S | Orange | AlGaInP | Water Clear | 200 120* | 347 297* | 610* | 120° |

*Luminous intensity value and wavelength are in accordance with CIE127-2007 standards.

Handling Precautions

Compare to epoxy encapsulant that is hard and brittle, silicone is softer and flexible. Although its characteristic significantly reduces thermal stress, it is more susceptible to damage by external mechanical force.

As a result, special handling precautions need to be observed during assembly using silicone encapsulated LED products. Failure to comply might lead to damage and premature failure of the LED.

1. Handle the component along the side surfaces by using forceps or appropriate tools.

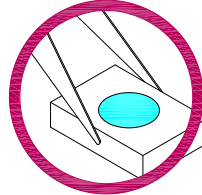

2. Do not directly touch or handle the silicone lens surface. It may damage the internal circuitry.

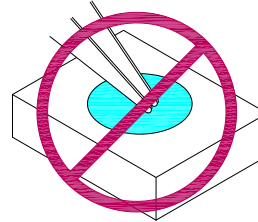
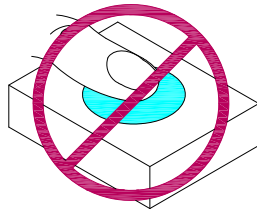

3. Do not stack together assembled PCBs containing exposed LEDs. Impact may scratch the silicone lens or damage the internal circuitry.

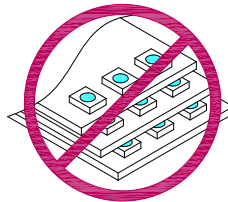

- 4.1. The inner diameter of the SMD pickup nozzle should not exceed the size of the LED to prevent air leaks.
- 4.2. A pliable material is suggested for the nozzle tip to avoid scratching or damaging the LED surface during pickup.
- 4.3. The dimensions of the component must be accurately programmed in the pick-and-place machine to insure precise pickup and avoid damage during production.

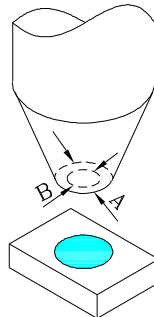

5. As silicone encapsulation is permeable to gases, some corrosive substances such as H_2S might corrode silver plating of leadframe. Special care should be taken if an LED with silicone encapsulation is to be used near such substances.

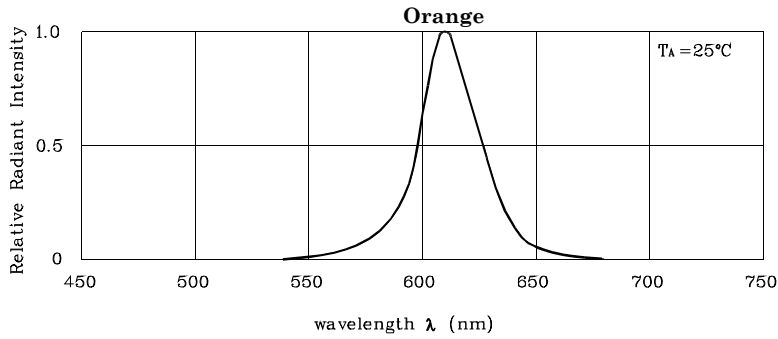

RELATIVE INTENSITY Vs. CIE WAVELENGTH

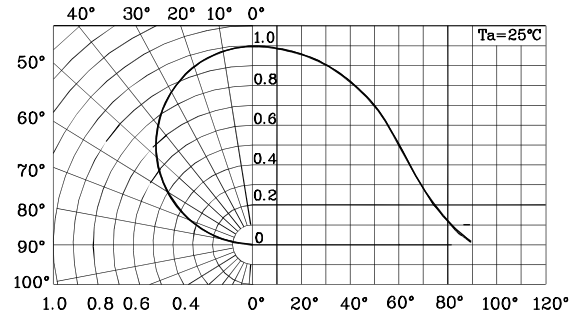

SPATIAL DISTRIBUTION

❖ Orange

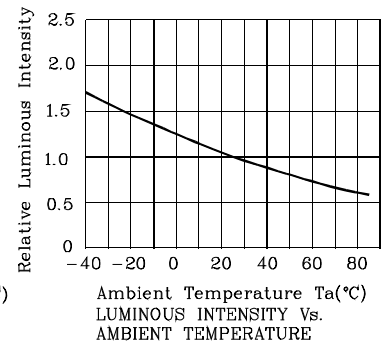
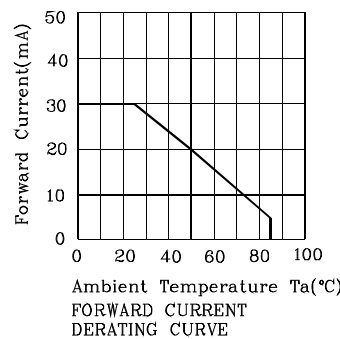
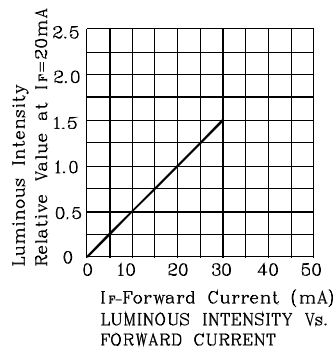
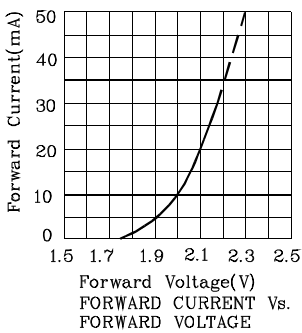

LED is recommended for reflow soldering and soldering profile is shown below.

Reflow Soldering Profile for SMD Products (Pb-Free Components)

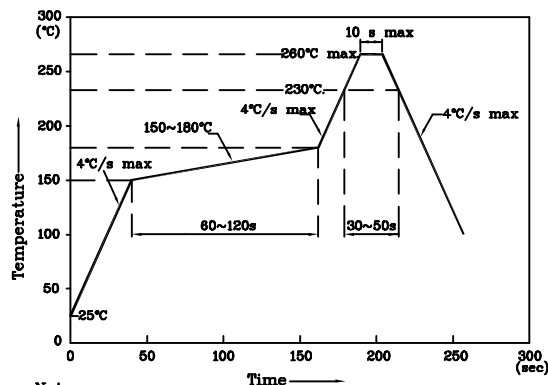



❖ The device has a single mounting surface.
The device must be mounted according to the specifications.

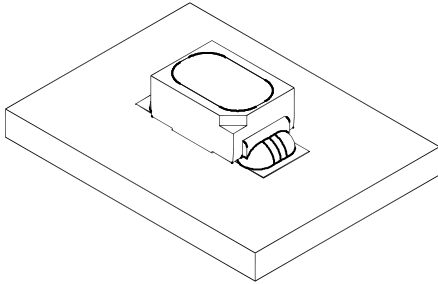

❖ Recommended Soldering Pattern
(Units : mm; Tolerance: ± 0.1)

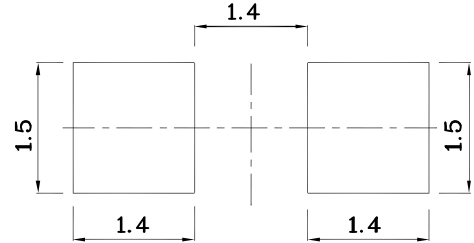

❖ Reel Dimension

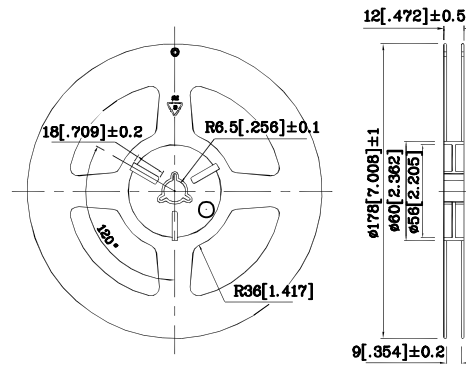

❖ Tape Specification (Units : mm)

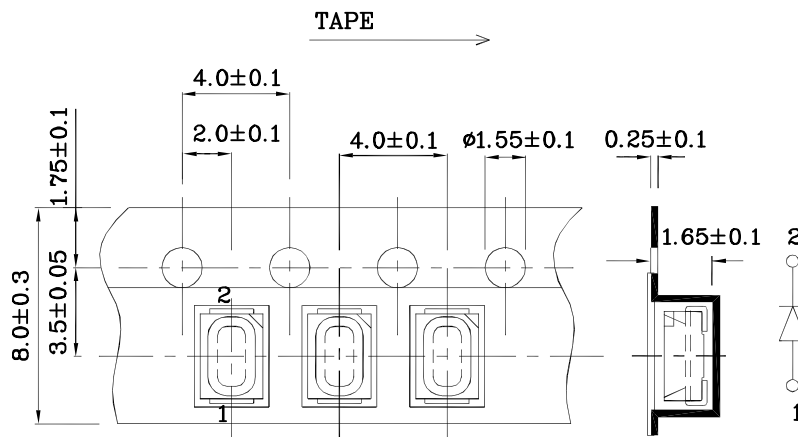



Remarks:

If special sorting is required (e.g. binning based on forward voltage, Luminous intensity / luminous flux, or wavelength), the typical accuracy of the sorting process is as follows:

1. Wavelength: +/-1nm
2. Luminous intensity / luminous flux: +/-15%
3. Forward Voltage: +/-0.1V

Note: Accuracy may depend on the sorting parameters.

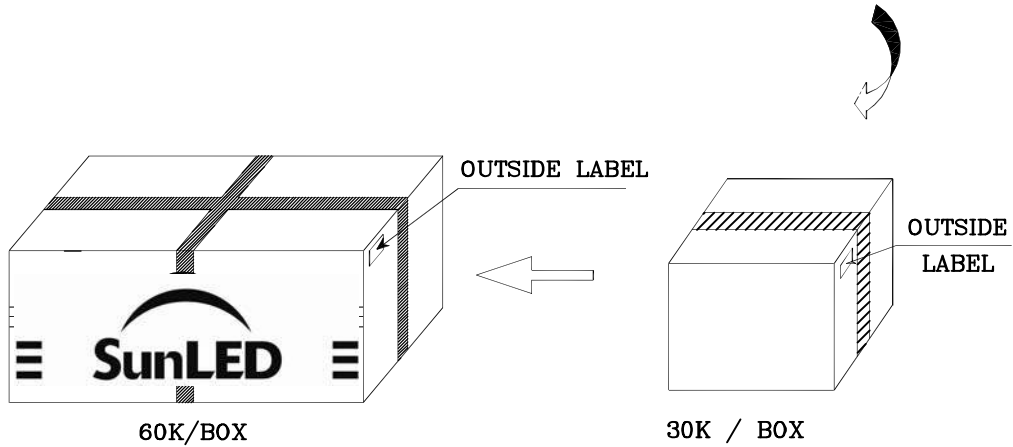
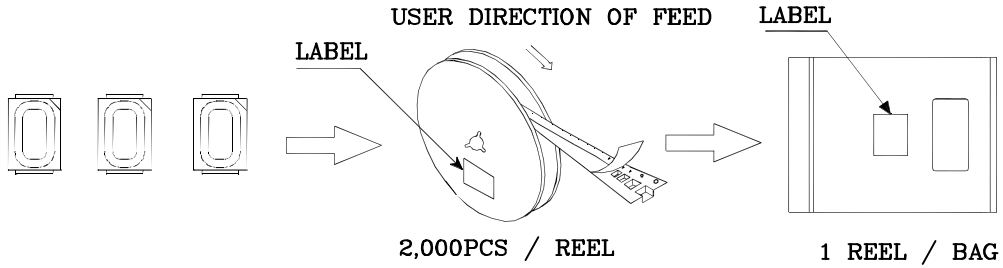
PACKING & LABEL SPECIFICATIONS

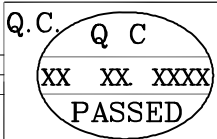
| | |
|--|-----------|
| P/NO : XZxxx105x | |
| QTY : 2,000 pcs | CODE: XXX |
| S/N : XX | |
| LOT NO : | |
|  XXXXXXXXXXXXXXXXXXXXXXXXXXXX | |
| RoHS Compliant | |

TERMS OF USE

1. Data presented in this document reflect statistical figures and should be treated as technical reference only.
2. Contents within this document are subject to improvement and enhancement changes without notice.
3. The product(s) in this document are designed to be operated within the electrical and environmental specifications indicated on the datasheet. User accepts full risk and responsibility when operating the product(s) beyond their intended specifications.
4. The product(s) described in this document are intended for electronic applications in which a person's life is not reliant upon the LED. Please consult with a SunLED representative for special applications where the LED may have a direct impact on a person's life.
5. The contents within this document may not be altered without prior consent by SunLED.
6. Additional technical notes are available at <http://www.SunLEDusa.com/TechnicalNotes.asp>