

## FW250F1 and FW300F1 Power Modules: dc-dc Converters; 36 to 75 Vdc Input, 3.3 Vdc Output; 165 W to 198 W

---

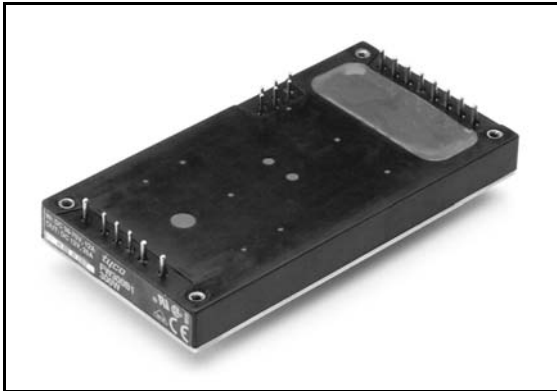

The FW250F1 and FW300F1 Power Modules use advanced, surface-mount technology and deliver high-quality, compact, dc-dc conversion at an economical price.

### Applications

- Redundant and/or distributed power architectures
- Telecommunications
- Data processing

### Options

- Heat sinks available for extended operation

### Description

The FW250F1 and FW300F1 Power Modules are dc-dc converters that operate over an input voltage range of 36 Vdc to 75 Vdc and provide a precisely regulated dc output. The outputs are fully isolated from the inputs, allowing versatile polarity configurations and grounding connections. The modules have maximum power ratings from 250 W to 300 W at a typical full-load efficiency of 79%.

Two or more modules may be paralleled with forced load sharing for redundant or enhanced power applications. The package, which mounts on a printed-circuit board, accommodates a heat sink for high-temperature applications.

### Features

- Size: 61.0 mm x 116.8 mm x 13.5 mm (2.40 in. x 4.60 in. x 0.53 in.)
- Wide input voltage range
- High efficiency: 79% typical
- Parallel operation with load sharing
- Output voltage set-point adjustment (trim)
- Thermal protection
- Synchronization
- Power good signal
- Output current monitor
- Output overvoltage and overcurrent protection
- Constant frequency
- Case ground pin
- Input-to-output isolation
- Remote sense
- Remote on/off
- Short-circuit protection
- Output overvoltage clamp
- ISO9001 Certified manufacturing facilities
- *UL*\* 60950 Recognized, *CSA*† 22.2 No. 60950-00 Certified, VDE 0805 (IEC60950, 3rd ed.) Licensed
- CE mark meets 73/23/EEC and 93/68/EEC directives‡

\* *UL* is a registered trademark of Underwriters Laboratories, Inc.

† *CSA* is a registered trademark of Canadian Standards Association.

‡ This product is intended for integration into end-use equipment. All the required procedures for CE marking of end-use equipment should be followed. (The CE mark is placed on selected products.)

## Absolute Maximum Ratings

Stresses in excess of the absolute maximum ratings can cause permanent damage to the device. These are absolute stress ratings only. Functional operation of the device is not implied at these or any other conditions in excess of those given in the operations sections of the data sheet. Exposure to absolute maximum ratings for extended periods can adversely affect device reliability.

Parameter	Symbol	Min	Max	Unit
Input Voltage: Continuous	$V_I$	—	80	Vdc
Transient (100 ms)	$V_{I, trans}$	—	100	Vdc
I/O Isolation Voltage	—	—	1500	V
Operating Case Temperature (See Thermal Considerations section and Figure 24.)	$T_C$	-40	100	°C
Storage Temperature	$T_{stg}$	-55	125	°C

## Electrical Specifications

Unless otherwise indicated, specifications apply over all operating input voltage, resistive load, and temperature conditions.

**Table 1. Input Specifications**

Parameter	Symbol	Min	Typ	Max	Unit
Operating Input Voltage	$V_I$	36	48	75	Vdc
Maximum Input Current ( $V_I = 0$ V to 75 V): FW250F1	$I_{I, max}$	—	—	10	A
FW300F1	$I_{I, max}$	—	—	12	A
Inrush Transient	$i^2t$	—	—	2.0	A <sup>2</sup> s
Input Reflected-ripple Current, Peak-to-peak (5 Hz to 20 MHz, 12 $\mu$ H source impedance; see Figure 14.)	—	—	10	—	mAp-p
Input Ripple Rejection (120 Hz)	—	—	60	—	dB

## Fusing Considerations

**CAUTION: This power module is not internally fused. An input line fuse must always be used.**

This encapsulated power module can be used in a wide variety of applications, ranging from simple stand-alone operation to an integrated part of a sophisticated power architecture. To preserve maximum flexibility, internal fusing is not included; however, to achieve maximum safety and system protection, always use an input line fuse. The safety agencies require a normal-blow, dc fuse with a maximum rating of 20 A (see Safety Considerations section). Based on the information provided in this data sheet on inrush energy and maximum dc input current, the same type of fuse with a lower rating can be used. Refer to the fuse manufacturer's data for further information.

**Electrical Specifications** (continued)

**Table 2. Output Specifications**

Parameter	Symbol	Min	Typ	Max	Unit
Output Voltage Set Point ( $V_I = 48\text{ V}$ ; $I_O = I_{O, \text{max}}$ ; $T_C = 25\text{ }^\circ\text{C}$ )	$V_{O, \text{set}}$	3.25	3.3	3.35	Vdc
Output Voltage (Over all operating input voltage, resistive load, and temperature conditions until end of life; see Figure 15 and Feature Descriptions.)	$V_O$	3.20	—	3.40	Vdc
Output Regulation: Line ( $V_I = 36\text{ V}$ to $75\text{ V}$ )	—	—	0.01	0.1	%
Load ( $I_O = I_{O, \text{min}}$ to $I_{O, \text{max}}$ )	—	—	0.05	0.2	%
Temperature ( $T_C = -40\text{ }^\circ\text{C}$ to $+100\text{ }^\circ\text{C}$ )	—	—	15	50	mV
Output Ripple and Noise Voltage (See Figures 7, 8, and 16.):					
RMS	—	—	—	40	mVrms
Peak-to-peak (5 Hz to 20 MHz)	—	—	—	150	mVp-p
Output Current (At $I_O < I_{O, \text{min}}$ , the modules may exceed output ripple specifications.):					
FW250F1	$I_O$	0.5	—	50	A
FW300F1	$I_O$	0.5	—	60	A
Output Current-limit Inception ( $V_O = 90\%$ of $V_{O, \text{set}}$ ; see Feature Descriptions.)	$I_{O, \text{cli}}$	103*	—	130*	% $I_{O, \text{max}}$
Output Short-circuit Current ( $V_O = 1.0\text{ V}$ ; indefinite duration, no hiccup mode; see Figures 3 and 4.)	—	—	—	150	% $I_{O, \text{max}}$
External Load Capacitance (total for one unit or multiple paralleled units):					
FW250F1	—	0	—	†	$\mu\text{F}$
FW300F1	—	0	—	†	$\mu\text{F}$
Efficiency ( $V_I = 48\text{ V}$ ; $I_O = I_{O, \text{max}}$ ; $T_C = 25\text{ }^\circ\text{C}$ ; see Figures 5, 6, and 15.):					
FW250F1	$\eta$	—	79	—	%
FW300F1	$\eta$	—	79	—	%
Switching Frequency	—	—	475	—	kHz
Dynamic Response ( $\Delta I_O/\Delta t = 1\text{ A}/10\mu\text{s}$ , $V_I = 48\text{ V}$ , $T_C = 25\text{ }^\circ\text{C}$ ; tested with a $10\text{ }\mu\text{F}$ aluminum and a $1.0\text{ }\mu\text{F}$ ceramic capacitor across the load; see Figures 9 through 12.):					
Load Change from $I_O = 50\%$ to $75\%$ of $I_{O, \text{max}}$ :					
Peak Deviation	—	—	2	—	% $V_{O, \text{set}}$
Settling Time ( $V_O < 10\%$ of peak deviation)	—	—	200	—	$\mu\text{s}$
Load Change from $I_O = 50\%$ to $25\%$ of $I_{O, \text{max}}$ :					
Peak Deviation	—	—	2	—	% $V_{O, \text{set}}$
Settling Time ( $V_O < 10\%$ of peak deviation)	—	—	200	—	$\mu\text{s}$

\* These are manufacturing test limits. In some situations, results may differ.

† Please consult your sales representative or the factory.

**Electrical Specifications** (continued)

**Table 3. Isolation Specifications**

Parameter	Min	Typ	Max	Unit
Isolation Capacitance	—	1700	—	pF
Isolation Resistance	10	—	—	mΩ

**General Specifications**

Parameter	Min	Typ	Max	Unit
Calculated MTBF ( $I_o = 80\%$ of $I_{o, max}$ ; $T_c = 40\text{ °C}$ )	1,700,000			hours
Weight	—	—	200 (7)	g (oz.)

## Feature Specifications

Unless otherwise indicated, specifications apply over all operating input voltage, resistive load, and temperature conditions. See Feature Descriptions for further information.

Parameter	Symbol	Min	Typ	Max	Unit
Remote On/Off Signal Interface ( $V_i = 0\text{ V}$ to $75\text{ V}$ ; open collector or equivalent compatible; signal referenced to $V_i(-)$ terminal; see Figure 17 and Feature Descriptions.):					
Logic Low—Module On					
Logic High—Module Off					
Logic Low:					
At $I_{on/off} = 1.0\text{ mA}$	$V_{on/off}$	0	—	1.2	V
At $V_{on/off} = 0.0\text{ V}$	$I_{on/off}$	—	—	1.0	mA
Logic High:					
At $I_{on/off} = 0.0\text{ }\mu\text{A}$	$V_{on/off}$	—	—	15	V
Leakage Current	$I_{on/off}$	—	—	50	$\mu\text{A}$
Turn-on Time ( $I_o = 80\%$ of $I_{o, max}$ ; $V_o$ within $\pm 1\%$ of steady state)	—	—	30	50	ms
Output Voltage Overshoot	—	—	0	5	$\%V_{o, set}$
Output Voltage Adjustment (See Feature Descriptions.):					
Output Voltage Remote-sense Range	—	—	—	0.5	V
Output Voltage Set-point Adjustment Range (trim)	—	60	—	115	$\%V_{o, nom}$
Output Overvoltage Protection (shutdown)	—	4.0	—	5.0	V
Output Current Monitor ( $I_o = I_{o, max}$ , $T_c = 70\text{ }^\circ\text{C}$ )	$I_{o, mon}$	—	0.065	—	V/A
Synchronization:					
Clock Amplitude	—	4.00	—	5.00	V
Clock Pulse Width	—	0.4	—	—	$\mu\text{s}$
Fan-out	—	—	—	1	—
Capture Frequency Range	—	425	—	575	kHz
Overtemperature Shutdown (See Figure 24.)	$T_c$	—	105	—	$^\circ\text{C}$
Forced Load Sharing	—	—	10	—	$\%I_{o, rated}$
Power Good Signal Interface (See Feature Descriptions.):					
Low Impedance—Module Operating	$R_{pwr/good}$	—	—	100	$\Omega$
	$I_{pwr/good}$	—	—	1	mA
High Impedance—Module Off	$R_{pwr/good}$	1	—	—	m $\Omega$
	$V_{pwr/good}$	—	—	40	V

\* These are manufacturing test limits. In some situations, results may differ.

## Characteristic Curves

The following figures provide typical characteristics for the power modules.

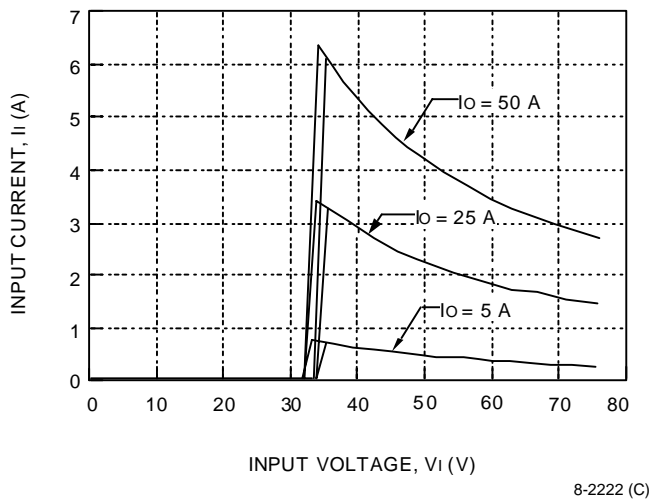

**Figure 1. Typical FW250F1 Input Characteristics at Room Temperature**

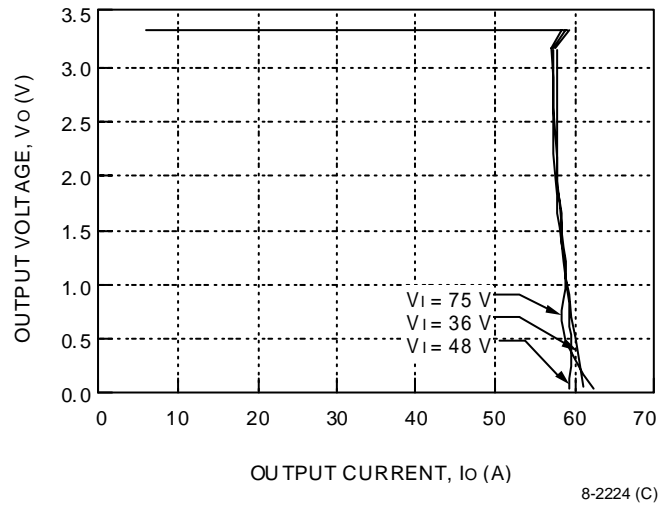

**Figure 3. Typical FW250F1 Output Characteristics at Room Temperature**

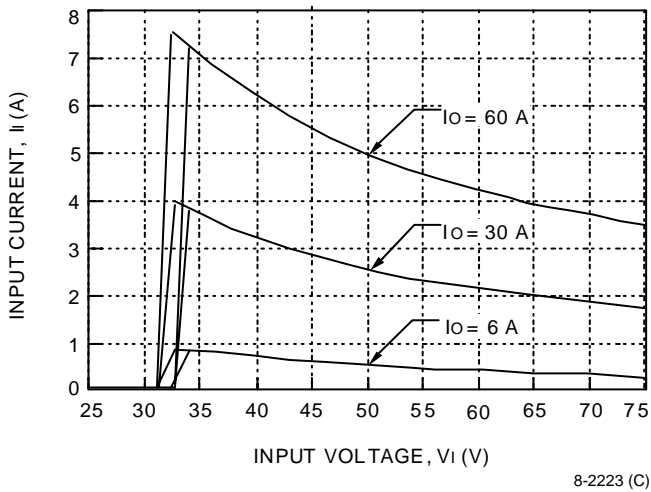

**Figure 2. Typical FW300F1 Input Characteristics at Room Temperature**

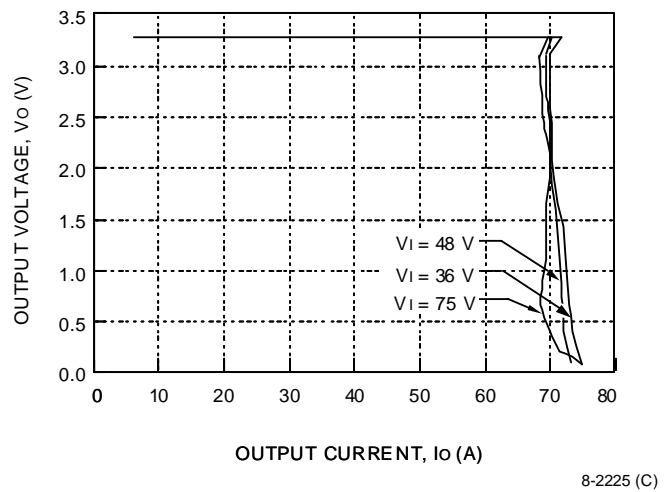

**Figure 4. Typical FW300F1 Output Characteristics at Room Temperature**

Characteristic Curves (continued)

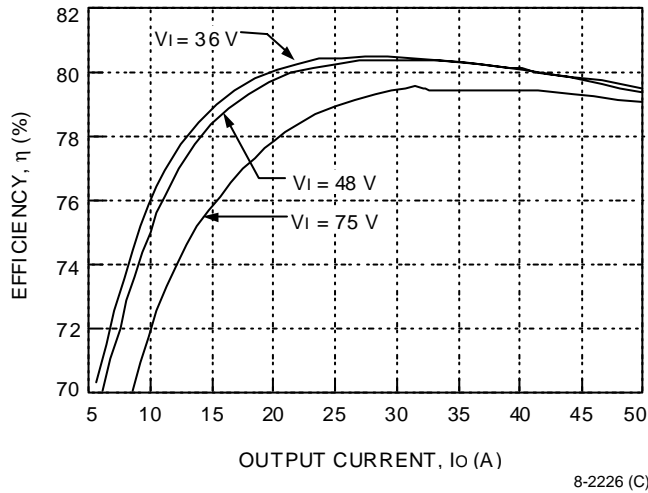

Figure 5. Typical FW250F1 Efficiency vs. Output Current at Room Temperature

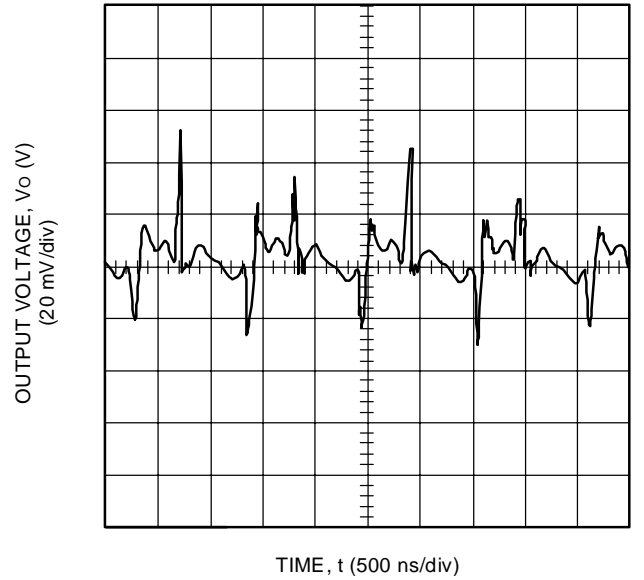

Figure 7. Typical FW250F1 Output Ripple Voltage at Room Temperature, 48 V Input, and 50 A Output

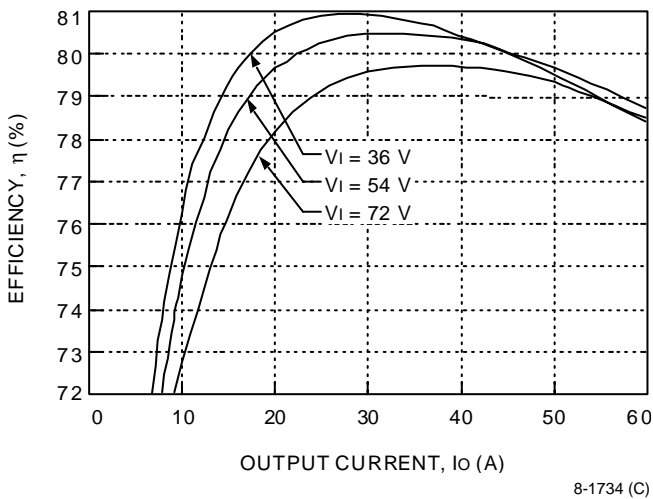

Figure 6. Typical FW300F1 Efficiency vs. Output Current at Room Temperature

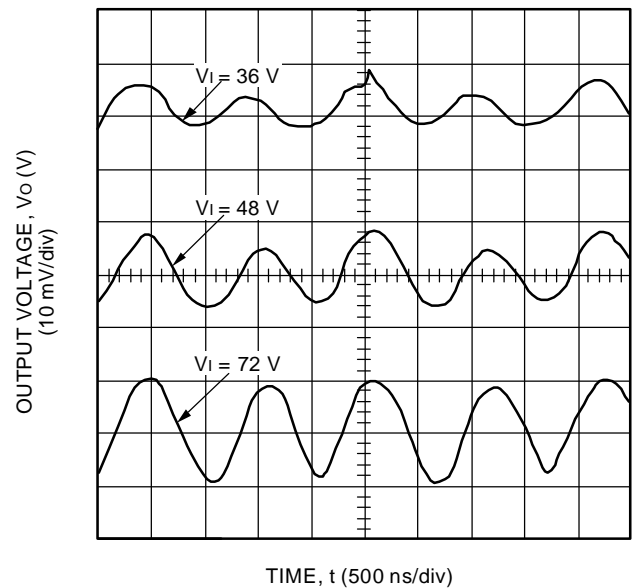
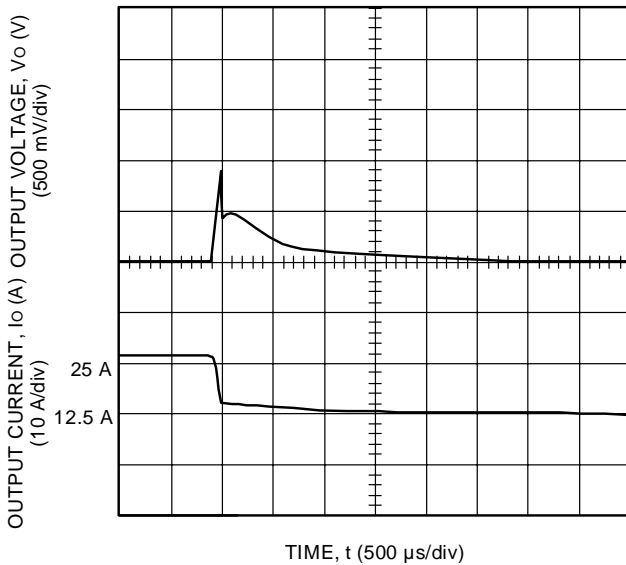

Figure 8. Typical FW300F1 Output Ripple Voltage at Room Temperature and 60 A Output

**Characteristic Curves** (continued)



8-2228 (C)

Note: Tested with a 10  $\mu$ F aluminum and a 1.0  $\mu$ F ceramic capacitor across the load.

**Figure 9. Typical FW250F1 Transient Response to Step Decrease in Load from 50% to 25% of Full Load at Room Temperature and 48 V Input (Waveform Averaged to Eliminate Ripple Component.)**

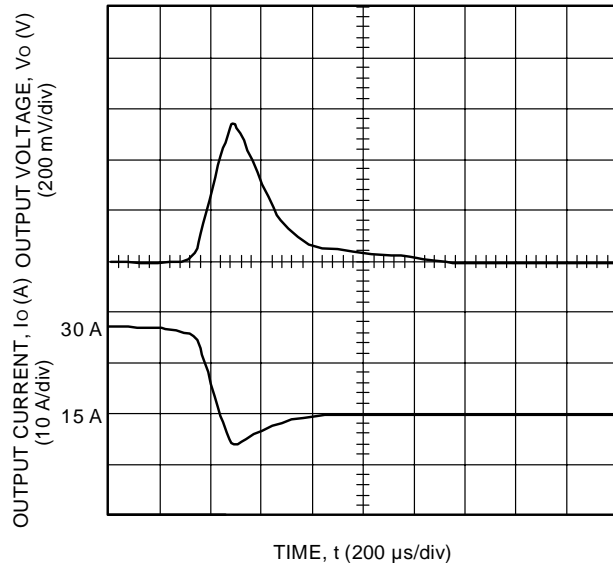

8-2230 (C)

Note: Tested with a 10  $\mu$ F aluminum and a 1.0  $\mu$ F ceramic capacitor across the load.

**Figure 11. Typical FW300F1 Transient Response to Step Decrease in Load from 50% to 25% of Full Load at Room Temperature and 48 V Input (Waveform Averaged to Eliminate Ripple Component.)**

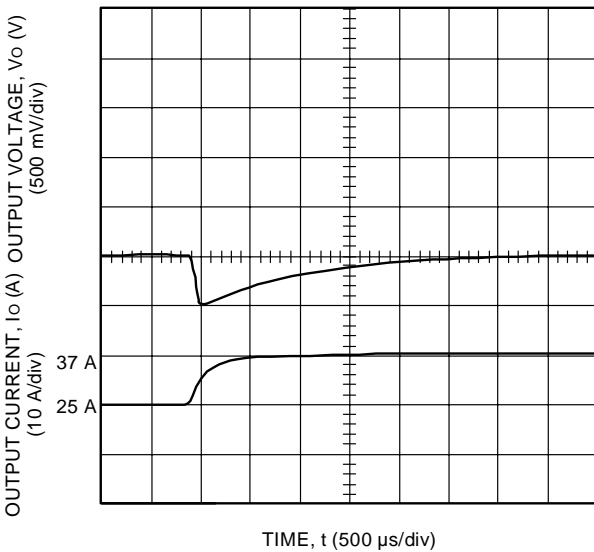

8-2229 (C)

Note: Tested with a 10  $\mu$ F aluminum and a 1.0  $\mu$ F ceramic capacitor across the load.

**Figure 10. Typical FW250F1 Transient Response to Step Increase in Load from 50% to 75% of Full Load at Room Temperature and 48 V Input (Waveform Averaged to Eliminate Ripple Component.)**

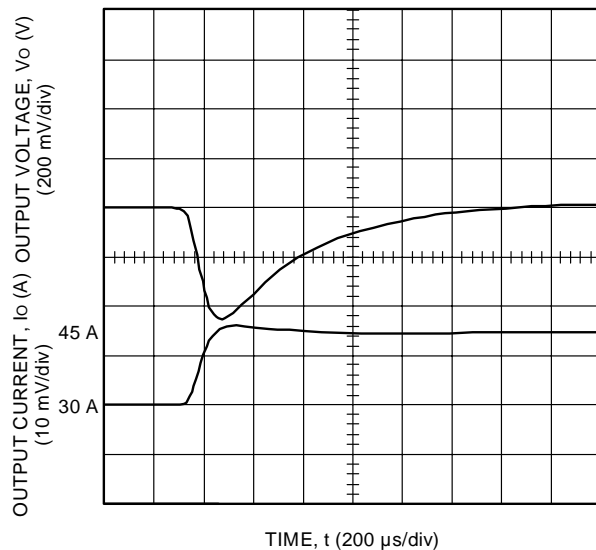

8-2231 (C)

Note: Tested with a 10  $\mu$ F aluminum and a 1.0  $\mu$ F ceramic capacitor across the load.

**Figure 12. Typical FW300F1 Transient Response to Step Increase in Load from 50% to 75% of Full Load at Room Temperature and 48 V Input (Waveform Averaged to Eliminate Ripple Component.)**



### Characteristic Curves (continued)

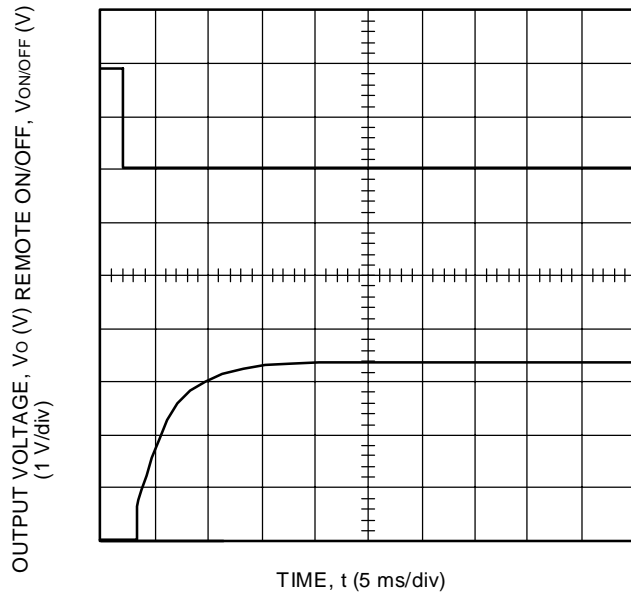

8-1736 (C)

Note: Tested with a 4000  $\mu\text{F}$  aluminum and a 1.0  $\mu\text{F}$  ceramic capacitor across the load.

**Figure 13. Typical FW300F1 Start-Up Transient at Room Temperature, 48 V Input, and Full Load**

### Test Configurations

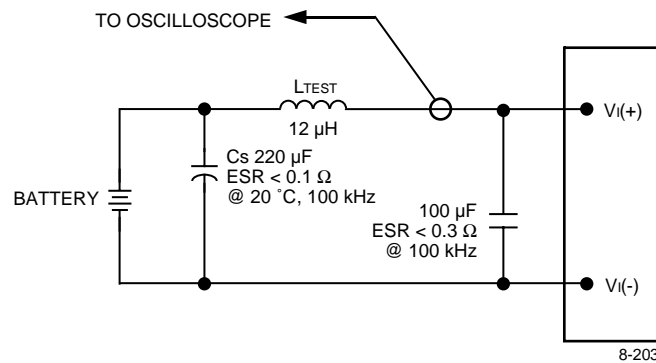

8-203

Note: Measure input reflected-ripple current with a simulated source inductance ( $L_{\text{TEST}}$ ) of 12  $\mu\text{H}$ . Capacitor  $C_s$  offsets possible battery impedance. Measure current as shown above.

**Figure 14. Input Reflected-Ripple Test Setup**

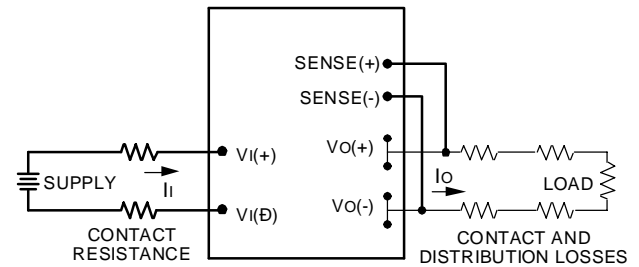

8-683 (C).f

Note: All measurements are taken at the module terminals. When socketing, place Kelvin connections at module terminals to avoid measurement errors due to socket contact resistance.

$$\eta = \left( \frac{[V_o(+)-V_o(-)]I_o}{[V_i(+)-V_i(-)]I_i} \right) \times 100 \quad \%$$

**Figure 15. Output Voltage and Efficiency Measurement Test Setup**

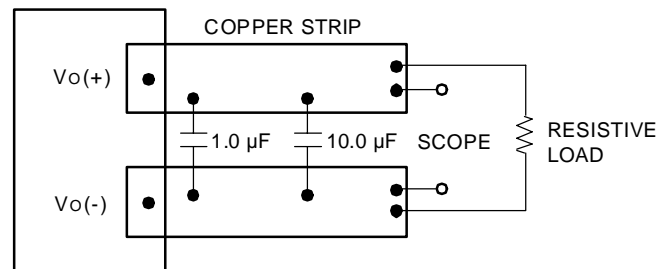

8-513 (C).m

Note: Use a 0.1  $\mu\text{F}$  ceramic capacitor and a 10  $\mu\text{F}$  aluminum or tantalum capacitor. Scope measurement should be made using a BNC socket. Position the load between 50 mm and 76 mm (2 in. and 3 in.) from the module.

**Figure 16. Peak-to-Peak Output Noise Measurement Test Setup**

### Design Considerations

#### Input Source Impedance

The power module should be connected to a low ac-impedance input source. Highly inductive source impedances can affect the stability of the power module. For the test configuration in Figure 14, a 100  $\mu\text{F}$  electrolytic capacitor (ESR < 0.3  $\Omega$  at 100 kHz) mounted close to the power module helps ensure stability of the unit. For other highly inductive source impedances, consult the factory for further application guidelines.

## Safety Considerations

For safety-agency approval of the system in which the power module is used, the power module must be installed in compliance with the spacing and separation requirements of the end-use safety agency standard, i.e., *UL1950*, *CSA C22.2 No. 950-95*, and *VDE 0805 (IEC60950, 3<sup>rd</sup> edition)*.

If the input source is non-SELV (ELV or a hazardous voltage greater than 60 Vdc and less than or equal to 75 Vdc), for the module's output to be considered meeting the requirements of safety extra-low voltage (SELV), all of the following must be true:

- The input source is to be provided with reinforced insulation from any hazardous voltages, including the ac mains; and
- One  $V_I$  pin and one  $V_O$  pin are to be grounded or both the input and output pins are to be kept floating; and
- The input pins of the module are not operator accessible; and
- Another SELV reliability test is conducted on the whole system, as required by the safety agencies, on the combination of supply source and the subject module to verify that under a single fault, hazardous voltages do not appear at the module's output.

**Note:** Do not ground either of the input pins of the module without grounding one of the output pins. This may allow a non-SELV voltage to appear between the output pin and ground.

The power module has extra-low voltage (ELV) outputs when all inputs are ELV.

The input to these units is to be provided with a maximum 20 A normal-blow fuse in the ungrounded lead.

## Feature Descriptions

### Overcurrent Protection

To provide protection in a fault (output overload) condition, the unit is equipped with internal current-limiting circuitry and can endure current limiting for an unlimited duration. At the point of current-limit inception, the unit shifts from voltage control to current control. If the output voltage is pulled very low during a severe fault, the current-limit circuit can exhibit either foldback or tailout characteristics (output-current decrease or increase). The unit operates normally once the output current is brought back into its specified range.

### Remote On/Off

To turn the power module on and off, the user must supply a switch to control the voltage between the on/off terminal and the  $V_I(-)$  terminal ( $V_{on/off}$ ). The switch can be an open collector or equivalent (see Figure 17). A logic low is  $V_{on/off} = 0$  V to 1.2 V, during which the module is on. The maximum  $I_{on/off}$  during a logic low is 1 mA. The switch should maintain a logic-low voltage while sinking 1 mA.

During a logic high, the maximum  $V_{on/off}$  generated by the power module is 15 V. The maximum allowable leakage current of the switch at  $V_{on/off} = 15$  V is 50  $\mu$ A.

If not using the remote on/off feature, short the ON/OFF pin to  $V_I(-)$ .

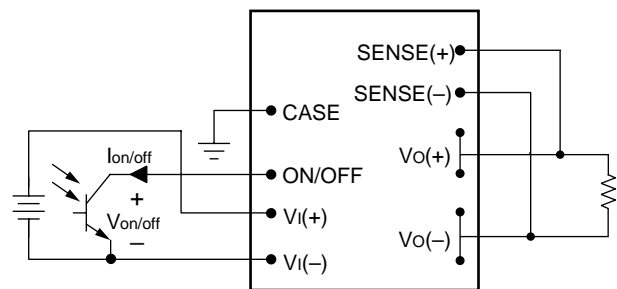

8-580

**Figure 17. Remote On/Off Implementation**

## Feature Descriptions (continued)

### Remote Sense

Remote sense minimizes the effects of distribution losses by regulating the voltage at the remote-sense connections. The voltage between the remote-sense pins and the output terminals must not exceed the output voltage sense range given in the Feature Specifications table, i.e.:

$$[V_o(+)-V_o(-)]-[SENSE(+)-SENSE(-)] \leq 0.5\text{ V}$$

The voltage between the  $V_o(+)$  and  $V_o(-)$  terminals must not exceed the minimum value indicated in the output overvoltage shutdown section of the Feature Specifications table. This limit includes any increase in voltage due to remote-sense compensation and output voltage set-point adjustment (trim), see Figure 18.

If not using the remote-sense feature to regulate the output at the point of load, connect SENSE(+) to  $V_o(+)$  and SENSE(-) to  $V_o(-)$  at the module.

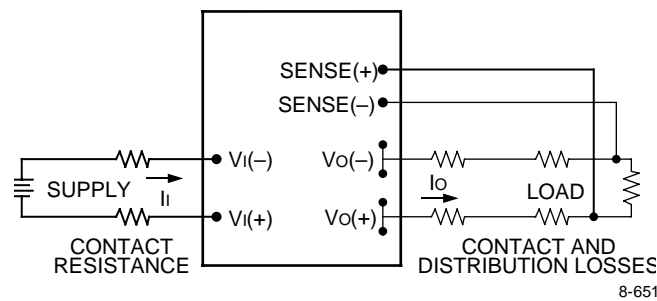

Figure 18. Effective Circuit Configuration for Single-Module Remote-Sense Operation

### Output Voltage Set-Point Adjustment (Trim)

Output voltage trim allows the user to increase or decrease the output voltage set point of a module. This is accomplished by connecting an external resistor between the TRIM pin and either the SENSE(+) or SENSE(-) pins. With an external resistor between the TRIM and SENSE(-) pins ( $R_{adj-down}$ ), the output voltage set point ( $V_{o,adj}$ ) decreases (see Figure 19). The following equation determines the required external-resistor value to obtain a percentage output voltage change of  $\Delta\%$ .

$$R_{adj-down} = \left( \frac{205}{\Delta\%} - 2.255 \right) \text{ k}\Omega$$

The test results for this configuration are displayed in Figure 20. This figure applies to all output voltages.

With an external resistor connected between the TRIM and SENSE(+) pins ( $R_{adj-up}$ ), the output voltage set point ( $V_{o,adj}$ ) increases (see Figure 21).

The following equation determines the required external-resistor value to obtain a percentage output voltage change of  $\Delta\%$ .

$$R_{adj-up} = \left( \frac{(V_{o,nom}(1 + \frac{\Delta\%}{100}) - 1.225)}{(1.225\Delta\%)} - 205 - 2.255 \right) \text{ k}\Omega$$

The test results for this configuration are displayed in Figure 22.

The voltage between the  $V_o(+)$  and  $V_o(-)$  terminals must not exceed the minimum value of the output overvoltage protection as indicated in the Feature Specifications table. This limit includes any increase in voltage due to remote-sense compensation and output voltage set-point adjustment (trim). See Figure 18.

If not using the trim feature, leave the TRIM pin open.

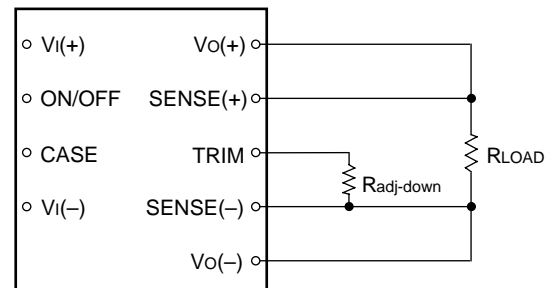

8-748 (C).b

Figure 19. Circuit Configuration to Decrease Output Voltage

Feature Descriptions (continued)

Output Voltage Set-Point Adjustment  
(Trim) (continued)

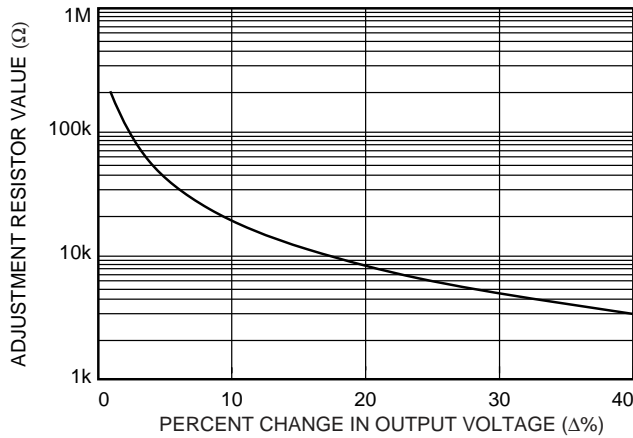

8-1171 (C).g

Figure 20. Resistor Selection for Decreased Output Voltage

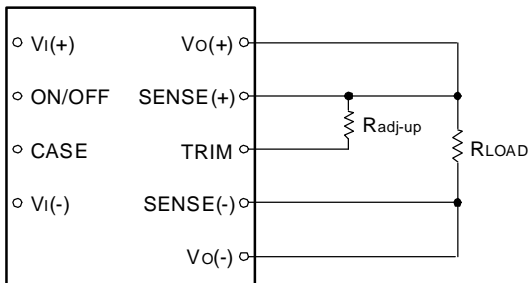

8-715 (C).b

Figure 21. Circuit Configuration to Increase Output Voltage

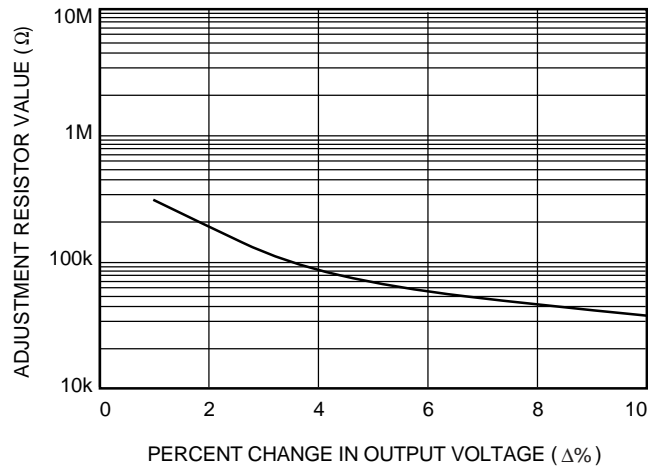

8-1172 (C).f

Figure 22. Resistor Selection for Increased Output Voltage

Output Overvoltage Protection

The output voltage is monitored at the Vo(+) and Vo(-) pins of the module. If the voltage at these pins exceeds the value indicated in the Feature Specifications table, the module will shut down and latch off. Recovery from latched shutdown is accomplished by cycling the dc input power off for at least 1.0 s or toggling the primary referenced on/off signal for at least 1.0 s.

Output Current Monitor

The CURRENT MON pin provides a dc voltage proportional to the dc output current of the module given in the Feature Specifications table. For example, on the FW250F1, the V/A ratio is set at 65 mV/A ± 10% @ 70 °C case. At a full load current of 50 A, the voltage on the CURRENT MON pin is 3.25 V. The current monitor signal is referenced to the SENSE(-) pin on the secondary and is supplied from a source impedance of approximately 2 kΩ. It is recommended that the CURRENT MON pin be left open when not in use, although no damage will result if the CURRENT MON pin is shorted to secondary ground. Directly driving the CURRENT MON pin with an external source will detrimentally affect operation of the module and should be avoided.

## Feature Descriptions (continued)

### Synchronization

Any module can be synchronized to any other module or to an external clock using the SYNC IN or SYNC OUT pins. The modules are not designed to operate in a master/slave configuration; that is, if one module fails, the other modules will continue to operate.

#### SYNC IN Pin

This pin can be connected either to an external clock or directly to the SYNC OUT pin of another FW250x or FW300x module.

If an external clock signal is applied to the SYNC IN pin, the signal must be a 500 kHz ( $\pm 50$  kHz) square wave with a 4 V<sub>p-p</sub> amplitude. Operation outside this frequency band will detrimentally affect the performance of the module and must be avoided.

If the SYNC IN pin is connected to the SYNC OUT pin of another module, the connection should be as direct as possible, and the V<sub>I(-)</sub> pins of the modules must be shorted together.

Unused SYNC IN pins should be tied to V<sub>I(-)</sub>. If the SYNC IN pin is unused, the module will operate from its own internal clock.

#### SYNC OUT Pin

This pin contains a clock signal referenced to the V<sub>I(-)</sub> pin. The frequency of this signal will equal either the module's internal clock frequency or the frequency established by an external clock applied to the SYNC IN pin.

When synchronizing several modules together, the modules can be connected in a daisy-chain fashion where the SYNC OUT pin of one module is connected to the SYNC IN pin of another module. Each module in the chain will synchronize to the frequency of the first module in the chain.

To avoid loading effects, ensure that the SYNC OUT pin of any one module is connected to the SYNC IN pin of only one module. Any number of modules can be synchronized in this daisy-chain fashion.

### Overtemperature Shutdown

To provide protection in a fault condition, the unit is equipped with an overtemperature shutdown circuit. The shutdown circuit will not engage unless the unit is operated above the maximum case temperature. Recovery from overtemperature shutdown is accomplished by cycling the dc input power off for at least 1.0 s or toggling the primary referenced on/off signal for at least 1.0 s.

### Forced Load Sharing (Parallel Operation)

For either redundant operation or additional power requirements, the power modules can be configured for parallel operation with forced load sharing (see Figure 23). For a typical redundant configuration, Schottky diodes or an equivalent should be used to protect against short-circuit conditions. Because of the remote sense, the forward-voltage drops across the Schottky diodes do not affect the set point of the voltage applied to the load. For additional power requirements, where multiple units are used to develop combined power in excess of the rated maximum, the Schottky diodes are not needed.

Good layout techniques should be observed for noise immunity. To implement forced load sharing, the following connections must be made:

- The parallel pins of all units must be connected together. The paths of these connections should be as direct as possible.
- All remote-sense pins should be connected to the power bus at the same point, i.e., connect all SENSE(+) pins to the (+) side of the power bus at the same point and all SENSE(-) pins to the (-) side of the power bus at the same point. Close proximity and directness are necessary for good noise immunity.

**Feature Descriptions** (continued)

**Forced Load Sharing (Parallel Operation)**

(continued)

When not using the parallel feature, leave the PARALLEL pin open.

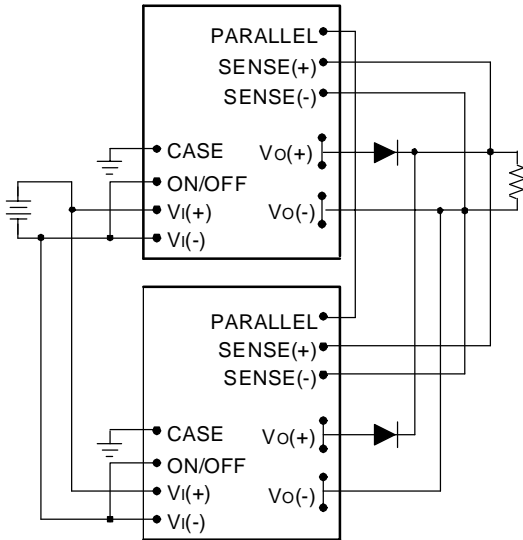

8-581 (C)

**Figure 23. Wiring Configuration for Redundant Parallel Operation**

**Power Good Signal**

The PWR GOOD pin provides an open-drain signal (referenced to the SENSE(-) pin) that indicates the operating state of the module. A low impedance (<math><100 \Omega</math>) between PWR GOOD and SENSE(-) indicates that the module is operating. A high impedance (>1 M $\Omega$ ) between PWR GOOD and SENSE(-) indicates that the module is off or has failed. The PWR GOOD pin can be pulled up through a resistor to an external voltage to facilitate sensing. This external voltage level must not exceed 40 V, and the current into the PWR GOOD pin during the low-impedance state should be limited to 1 mA maximum.

**Thermal Considerations**

**Introduction**

The power modules operate in a variety of thermal environments; however, sufficient cooling should be provided to help ensure reliable operation of the unit. Heat-dissipating components inside the unit are thermally coupled to the case. Heat is removed by conduction, convection, and radiation to the surrounding environment. Proper cooling can be verified by measuring the case temperature. Peak temperature occurs at the position indicated in Figure 24.

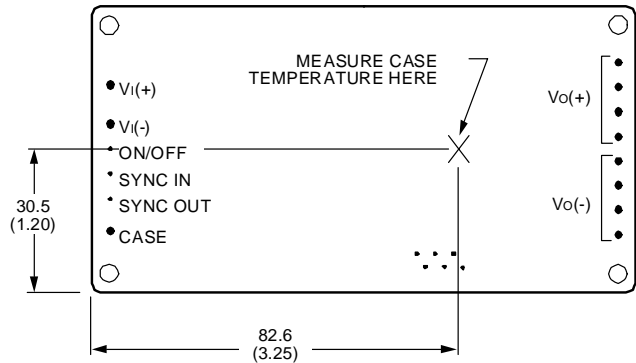

8-1303 (C).a

Note: Top view, measurements shown in millimeters and (inches). Pin locations are for reference only.

**Figure 24. Case Temperature Measurement Location**

The temperature at this location should not exceed 100 °C. The maximum case temperature can be limited to a lower value for extremely high reliability. The output power of the module should not exceed the rated power for the module as listed in the Ordering Information table.

For additional information about these modules, refer to the *Thermal Management for FC- and FW-Series 250 W—300 W Board-Mounted Power Modules Technical Note (TN96-009EPS)*.

**Thermal Considerations** (continued)

**Heat Transfer Without Heat Sinks**

Derating curves for forced-air cooling without a heat sink are shown in Figures 25 and 26. These curves can be used to determine the appropriate airflow for a given set of operating conditions. For example, if the unit with airflow along its length dissipates 20 W of heat, the correct airflow in a 40 °C environment is 1.0 m/s (200 ft./min.).

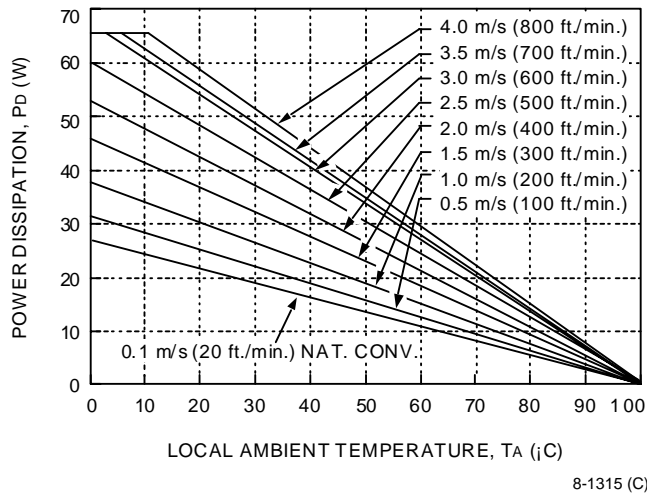

**Figure 25. Convection Power Derating with No Heat Sink; Airflow Along Width (Transverse)**

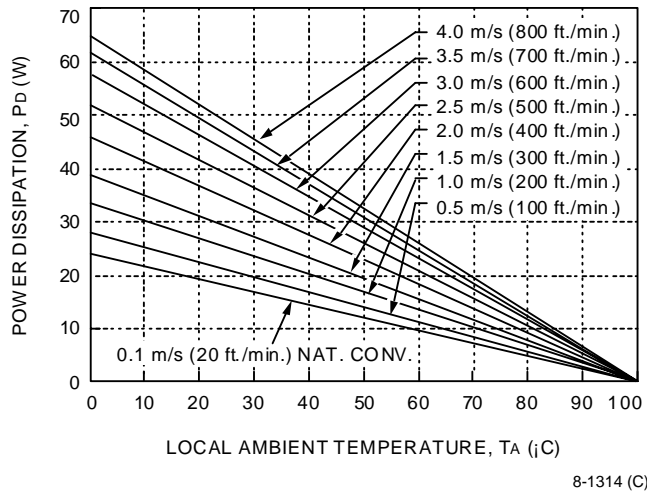

**Figure 26. Convection Power Derating with No Heat Sink; Airflow Along Length (Longitudinal)**

**Heat Transfer with Heat Sinks**

The power modules have through-threaded, M3 x 0.5 mounting holes, which enable heat sinks or cold plates to be attached to the module. The mounting torque must not exceed 0.56 N-m (5 in.-lb.). For the screw attachment from the pin side, the recommended hole size on the customer's PWB around the mounting holes is 0.130 ± 0.005 inches. If a larger hole is used, the mounting torque from the pin side must not exceed 0.25 N-m (2.2 in.-lbs.).

Thermal derating with heat sinks is expressed by using the overall thermal resistance of the module. Total module thermal resistance ( $\theta_{ca}$ ) is defined as the maximum case temperature rise ( $\Delta T_{C,max}$ ) divided by the module power dissipation ( $P_D$ ):

$$\theta_{ca} = \left[ \frac{\Delta T_{C,max}}{P_D} \right] = \left[ \frac{(T_C - T_A)}{P_D} \right]$$

The location to measure case temperature ( $T_C$ ) is shown in Figure 24. Case-to-ambient thermal resistance vs. airflow for various heat sink configurations is shown in Figure 27 and Figure 28. These curves were obtained by experimental testing of heat sinks, which are offered in the product catalog.

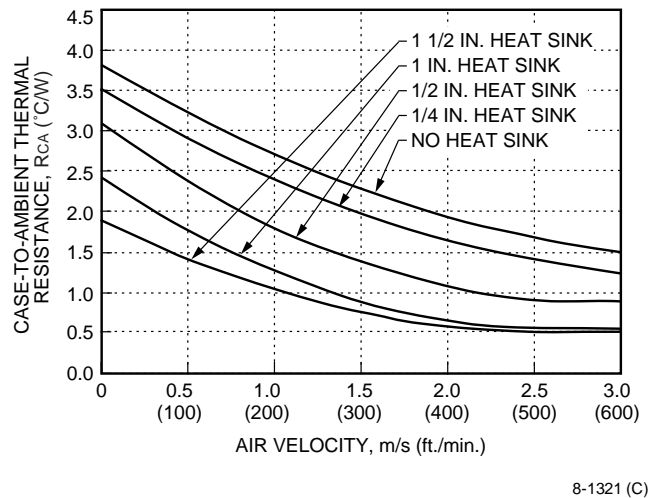

**Figure 27. Case-to-Ambient Thermal Resistance Curves; Transverse Orientation**

**Thermal Considerations** (continued)

**Heat Transfer with Heat Sinks** (continued)

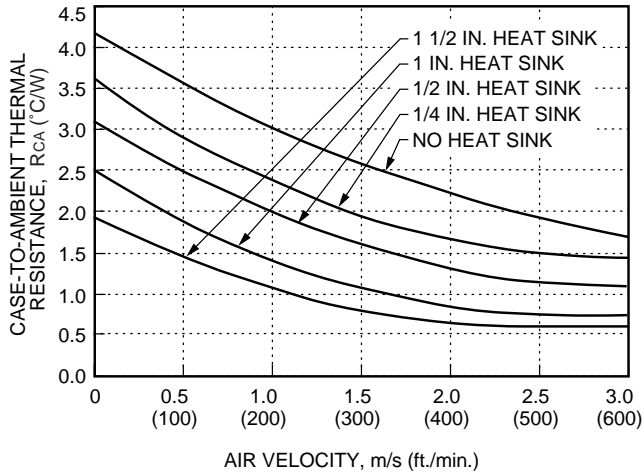

8-1320 (C)

**Figure 28. Case-to-Ambient Thermal Resistance Curves; Longitudinal Orientation**

These measured resistances are from heat transfer from the sides and bottom of the module as well as the top side with the attached heat sink; therefore, the case-to-ambient thermal resistances shown are generally lower than the resistance of the heat sink by itself. The module used to collect the data in Figures 27 and 28 had a thermal-conductive dry pad between the case and the heat sink to minimize contact resistance.

To choose a heat sink, determine the power dissipated as heat by the unit for the particular application. Figure 29 shows typical heat dissipation for a range of output currents and three voltages for the FW250F1 and FW300F1.

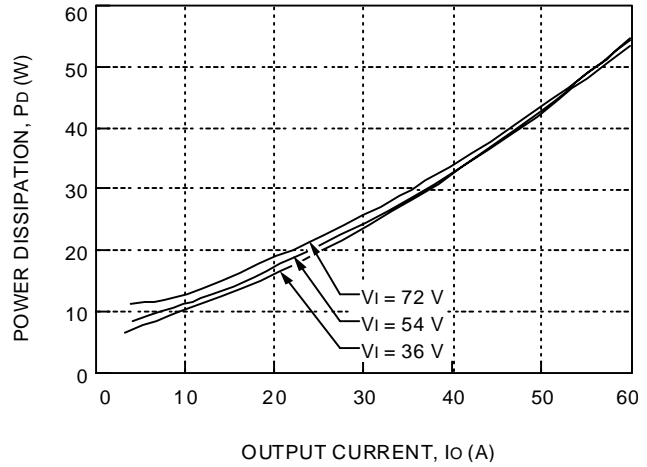

8-1737 (C)

**Figure 29. FW250F1 and FW300F1 Power Dissipation vs. Output Current**

**Example**

If an 85 °C case temperature is desired, what is the minimum airflow necessary? Assume the FW300F1 module is operating at nominal line and an output current of 50 A, maximum ambient air temperature of 40 °C, and the heat sink is 0.5 inch.

**Solution**

- Given:  $V_i = 54 \text{ V}$
- $I_o = 50 \text{ A}$
- $T_A = 40 \text{ }^\circ\text{C}$
- $T_C = 85 \text{ }^\circ\text{C}$
- Heat sink = 0.5 inch.

Determine  $P_D$  by using Figure 29:

$$P_D = 42 \text{ W}$$



## Thermal Considerations (continued)

### Heat Transfer with Heat Sinks (continued)

Then solve the following equation:

$$\theta_{ca} = \left[ \frac{(T_C - T_A)}{P_D} \right]$$

$$\theta_{ca} = \left[ \frac{(85 - 40)}{42} \right]$$

$$\theta_{ca} = 1.07 \text{ } ^\circ\text{C/W}$$

Use Figures 27 and 28 to determine air velocity for the 0.5 inch heat sink. The minimum airflow necessary for the FW250F1 module depends on heat sink fin orientation and is shown below:

- 2.0 m/s (400 ft./min.) (oriented along width)
- 3.0 m/s (600 ft./min.) (oriented along length)

### Custom Heat Sinks

A more detailed model can be used to determine the required thermal resistance of a heat sink to provide necessary cooling. The total module resistance can be separated into a resistance from case-to-sink ( $\theta_{cs}$ ) and sink-to-ambient ( $\theta_{sa}$ ) as shown in Figure 30.

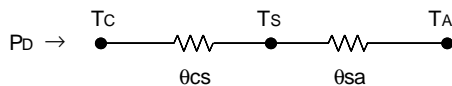

8-1304 (C)

**Figure 30. Resistance from Case-to-Sink and Sink-to-Ambient**

For a managed interface using thermal grease or foils, a value of  $\theta_{cs} = 0.1 \text{ } ^\circ\text{C/W}$  to  $0.3 \text{ } ^\circ\text{C/W}$  is typical. The solution for heat sink resistance is:

$$\theta_{sa} = \left[ \frac{(T_C - T_A)}{P_D} \right] - \theta_{cs}$$

This equation assumes that all dissipated power must be shed by the heat sink. Depending on the user-defined application environment, a more accurate model, including heat transfer from the sides and bottom of the module, can be used. This equation provides a conservative estimate for such instances.

## Solder, Cleaning, and Drying Considerations

Post solder cleaning is usually the final circuit-board assembly process prior to electrical testing. The result of inadequate circuit-board cleaning and drying can affect both the reliability of a power module and the testability of the finished circuit-board assembly. For guidance on appropriate soldering, cleaning, and drying procedures, refer to the *Board-Mounted Power Modules Soldering and Cleaning* Application Note (AP97-021EPS).

## EMC Considerations

For assistance with designing for EMC compliance, please refer to the FLTR100V10 data sheet (DS98-152EPS).

## Layout Considerations

Copper paths must not be routed beneath the power module standoffs. For additional layout guidelines, refer to the FLTR100V10 data sheet (DS98-152EPS).

**Outline Diagram**

Dimensions are in millimeters and (inches).

Tolerances: x.x mm ± 0.5 mm (x.xx in. ± 0.02 in.),  
 x.xx mm ± 0.25 mm (x.xxx in. ± 0.010 in.)

**Top View**

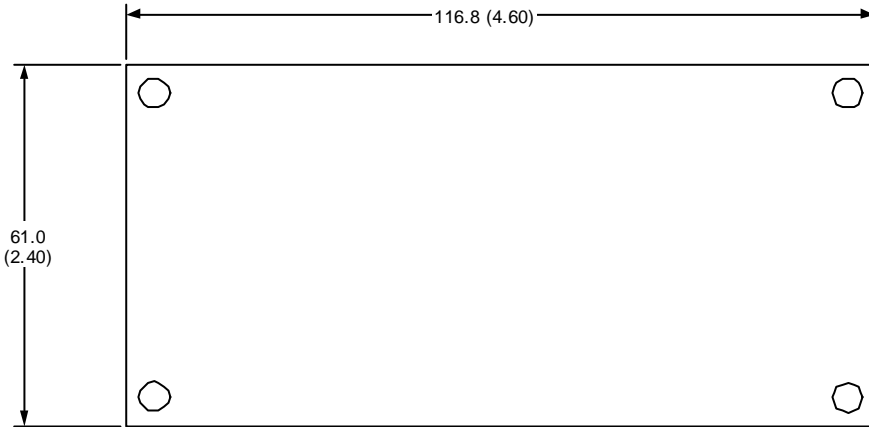

**Side View**

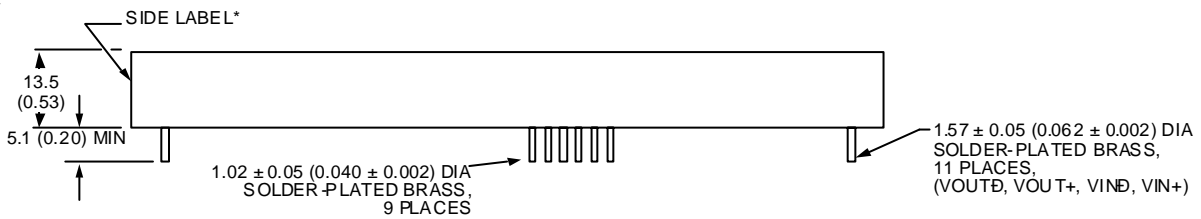

**Bottom View**

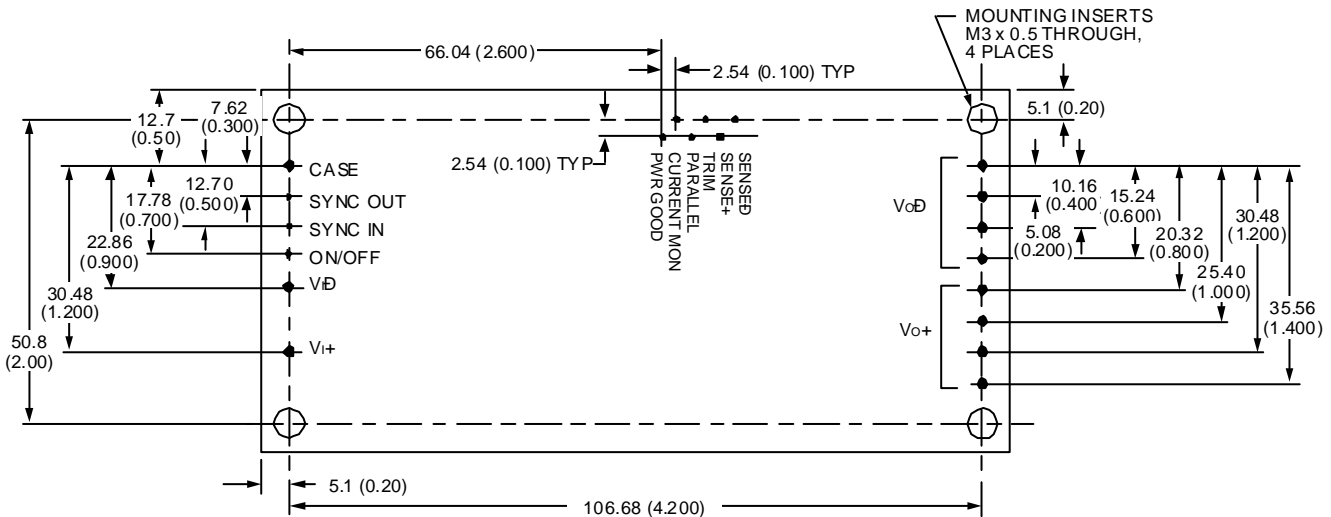

8-1650 (C)

\* Side label includes Tyco name, product designation, safety agency markings, input/output voltage and current ratings, and bar code.

## Recommended Hole Pattern

Component-side footprint.

Dimensions are in millimeters and (inches).

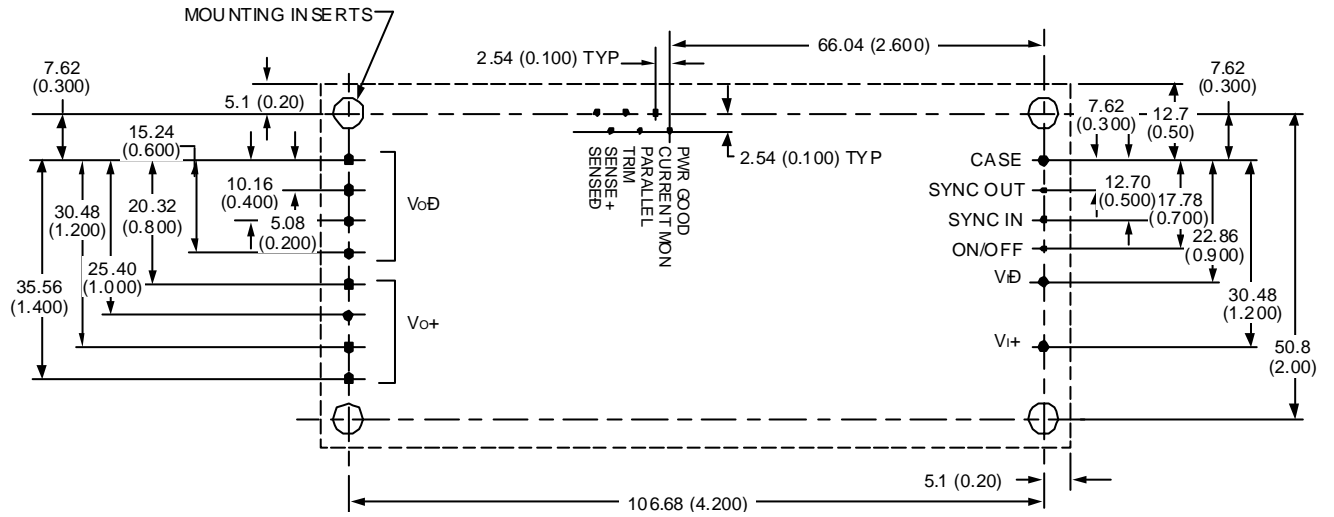

8-1650 (C)

## Ordering Information

Input Voltage	Output Voltage	Output Power	Device Code	Comcode
48 V	3.3 V	165 W	FW250F1	107859886
48 V	3.3 V	198 W	FW300F1	107253163

**Ordering Information** (continued)

**Table 4. Device Accessories**

Accessory	Comcode
1/4 in. transverse kit (heat sink, thermal pad, and screws)	847308335
1/4 in. longitudinal kit (heat sink, thermal pad, and screws)	847308327
1/2 in. transverse kit (heat sink, thermal pad, and screws)	847308350
1/2 in. longitudinal kit (heat sink, thermal pad, and screws)	847308343
1 in. transverse kit (heat sink, thermal pad, and screws)	847308376
1 in. longitudinal kit (heat sink, thermal pad, and screws)	847308368
1 1/2 in. transverse kit (heat sink, thermal pad, and screws)	847308392
1 1/2 in. longitudinal kit (heat sink, thermal pad, and screws)	847308384

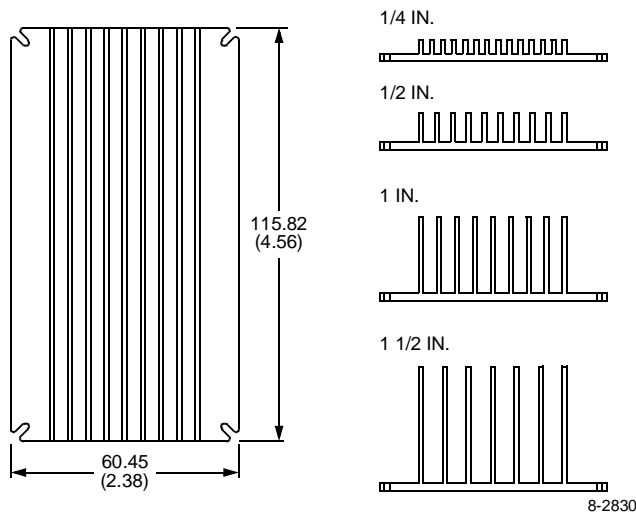

**Figure 31. Longitudinal Heat Sink**

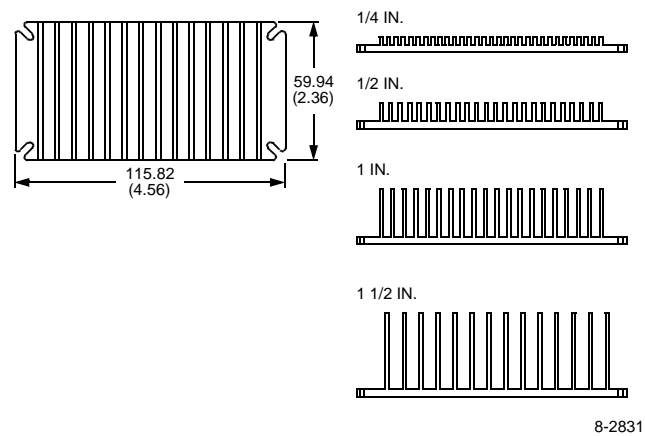

**Figure 32. Transverse Heat Sink**



**World Wide Headquarters**  
**Tyco Electronics Power Systems, Inc.**  
 3000 Skyline Drive, Mesquite, TX 75149, USA  
**+1-800-526-7819** FAX: +1-888-315-5182  
 (Outside U.S.A.: +1-972-284-2626, FAX: +1-972-284-2900)  
[www.power.tycoelectronics.com](http://www.power.tycoelectronics.com)  
 e-mail: [techsupport1@tycoelectronics.com](mailto:techsupport1@tycoelectronics.com)

**Europe, Middle-East and Africa Headquarters**  
 Tyco Electronics (UK) Ltd  
 Tel: +44 (0) 1344 469 300, Fax: +44 (0) 1344 469 301

**Central America-Latin America Headquarters**  
 Tyco Electronics Power Systems  
 Tel: +54 11 4316 2866, Fax: +54 11 4312 9508

**Asia-Pacific Headquarters**  
 Tyco Electronics Singapore Pte Ltd  
 Tel: +65 482 0311, Fax: 65 480 9299

Tyco Electronics Corporation reserves the right to make changes to the product(s) or information contained herein without notice. No liability is assumed as a result of their use or application. No rights under any patent accompany the sale of any such product(s) or information.

© 2001 Tyco Electronics Power Systems, Inc. (Mesquite, Texas) All International Rights Reserved.  
 Printed in U.S.A.

July 2002  
 FDS02-042EPS (Replaces DS97-519EPS)

