

**FEATURES**

- Combination Antenna (GPS+LTE+WIFI)
- Quadband Frequency
- RoHs Complaint

**APPLICATION**

- Tracking
- Fleet Management

**SPECIFICATIONS**

<b>Electrical</b>	
Frequency Range	1575.42MHz ± 3MHz
Polarization	RHCP
Gain	2dBic (Zenith)
V.S.W.R	<1.5
Impedance	50W
<b>LNA</b>	
Gain	28 ± 2 dB
Noise Figure	<2.0 dB
Supply Voltage	3 ~ 5VDC
Current Consumption	<15mA
V.S.W.R.	<2.0
<b>LTE</b>	
Frequency Range	698~960MHz/1710~2690MHz
V.S.W.R	<3.0
Polarization	Linear
Gain	3.5dBi (Zenith)
Impedance	50Ω
<b>WIFI</b>	
Frequency Range	2400~2483.5MHz
V.S.W.R	<2.0
Polarization	Linear
Gain	3.0 dBi (Zenith)
Impedance	50Ω
<b>Dimensions (mm):</b>	
Diameter (D)	181.7± 3.0
Width (W)	68.9 ± 3.0
Height (H)	69.1± 3.0
Connection Type	Fakra
Cable	RG174
Mounting Method	Screw



**RoHS Compliant**  
includes all homogeneous materials  
(see part numbering system for details)

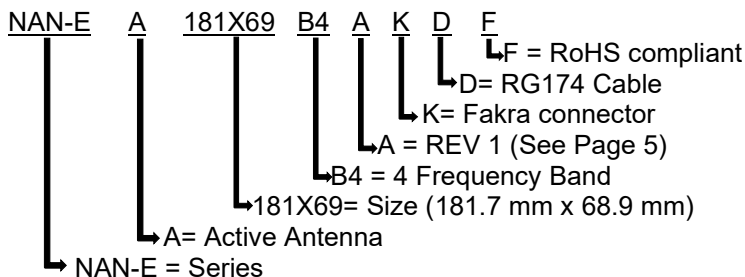

# GPS+ LTE+WIFI ANTENNA

# NAN-E SERIES

Environmental	
Operating Temperature	-40°C~+85°C
Relative Humidity	Up to 95%
Ingress Protection	IP67 (exclude cable outlet)
Vibration	10 ~ 1000Hz G=28.7m/s <sup>2</sup>
RoHS Compliant	Yes

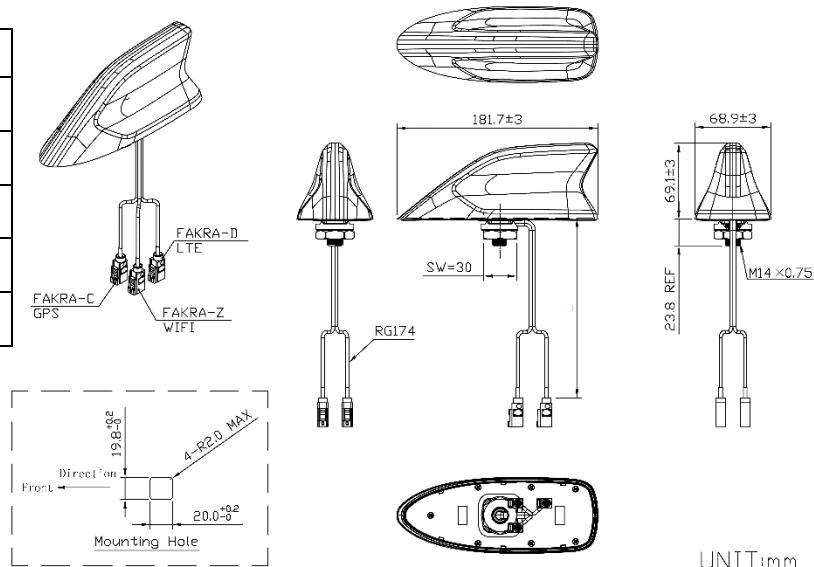

## RADIATION PATTERN

### GPS

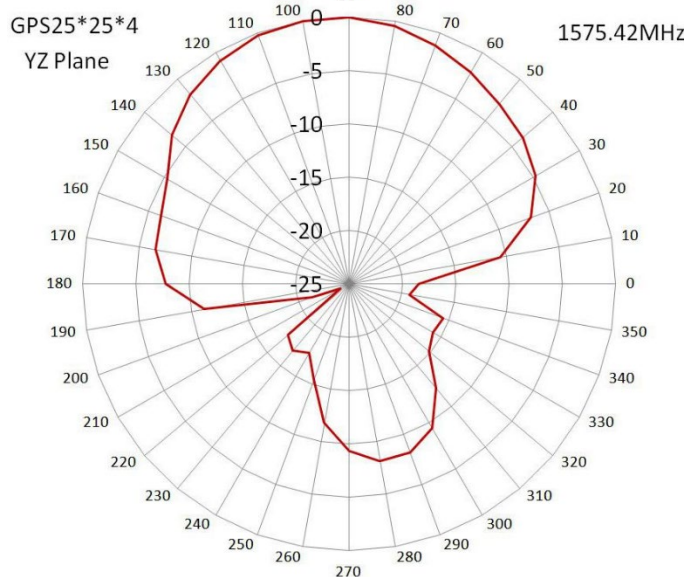
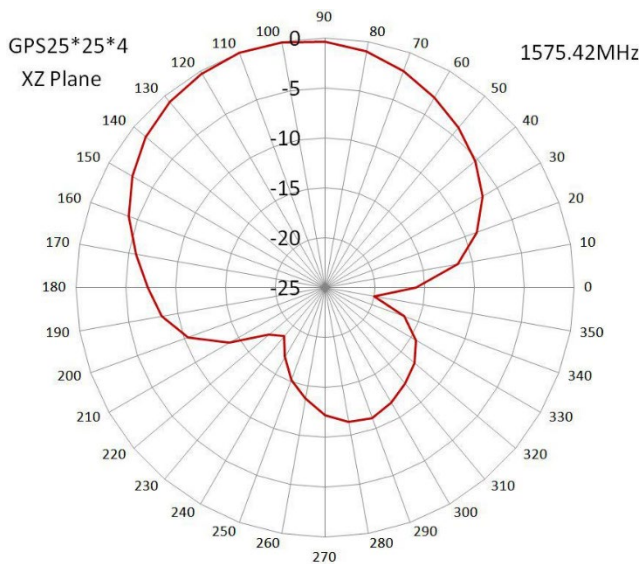
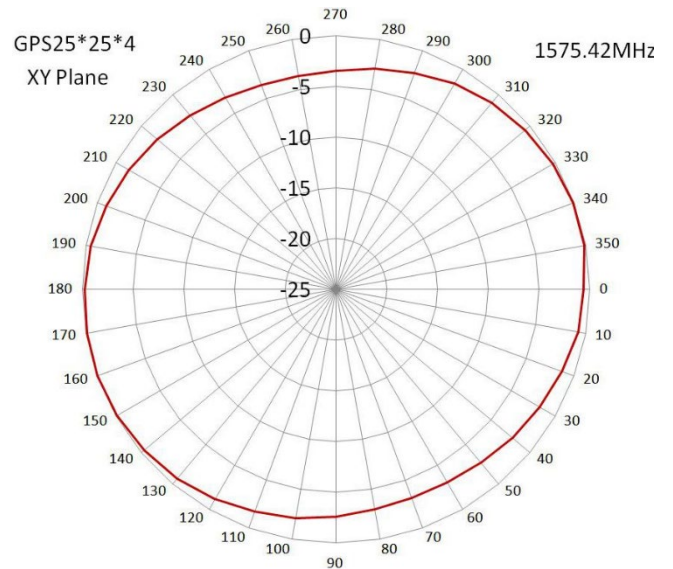
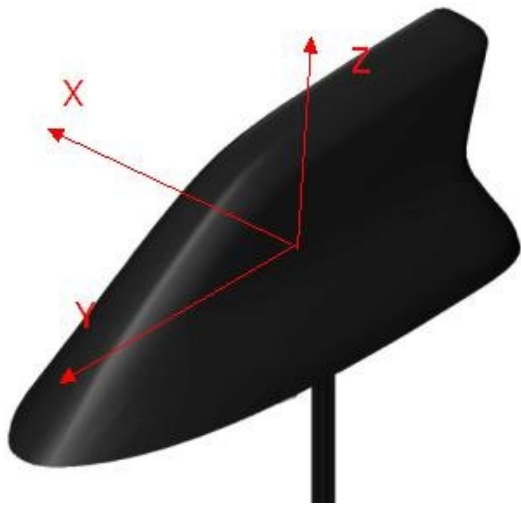

RADIATION PATTERN

LTE

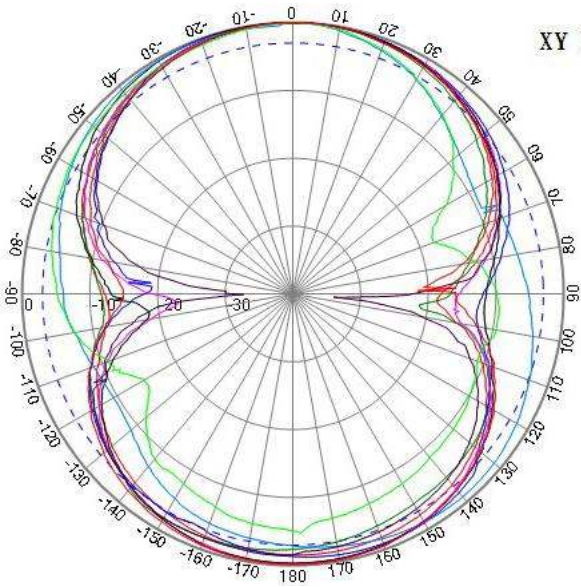

- Freq: 700
- Freq: 824
- Freq: 868
- Freq: 960
- Freq: 1710
- Freq: 1850
- Freq: 1990
- Freq: 2170
- Freq: 2690

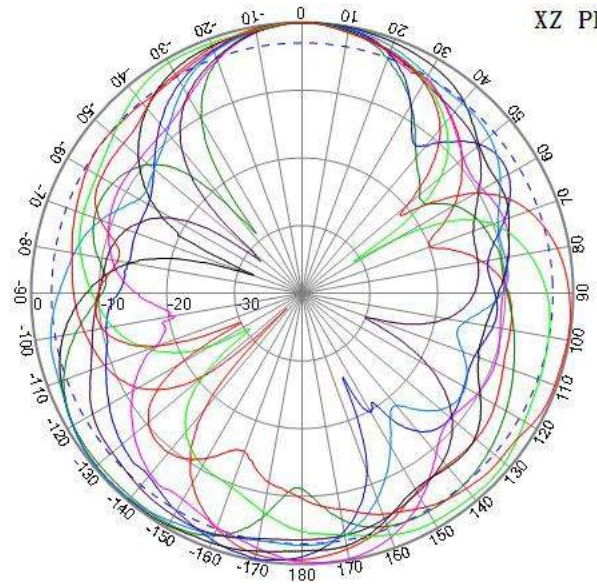

- Freq: 700
- Freq: 824
- Freq: 868
- Freq: 960
- Freq: 1710
- Freq: 1850
- Freq: 1990
- Freq: 2170
- Freq: 2690

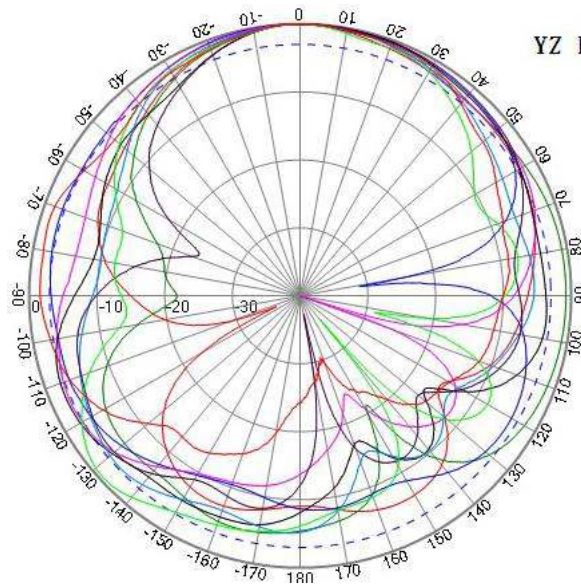

- Freq: 700
- Freq: 824
- Freq: 868
- Freq: 960
- Freq: 1710
- Freq: 1850
- Freq: 1990
- Freq: 2170
- Freq: 2690

RADIATION PATTERN

WIFI

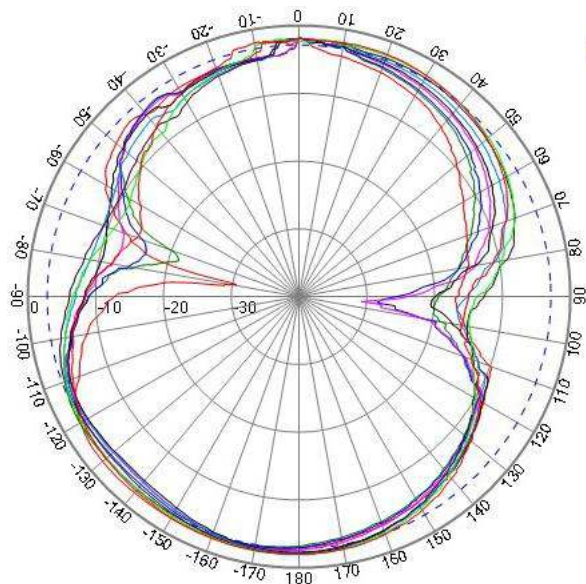

XY PLANE

- Freq: 2400
- Freq: 2410
- Freq: 2420
- Freq: 2430
- Freq: 2440
- Freq: 2450
- Freq: 2460
- Freq: 2470
- Freq: 2483

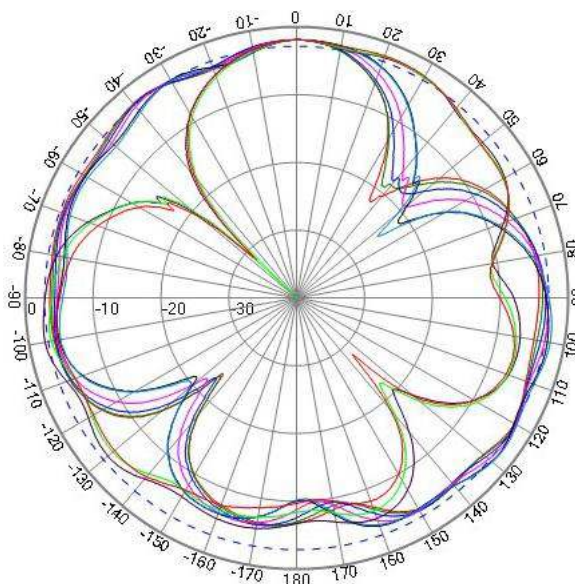

XZ PLANE

- Freq: 2400
- Freq: 2410
- Freq: 2420
- Freq: 2430
- Freq: 2440
- Freq: 2450
- Freq: 2460
- Freq: 2470
- Freq: 2483

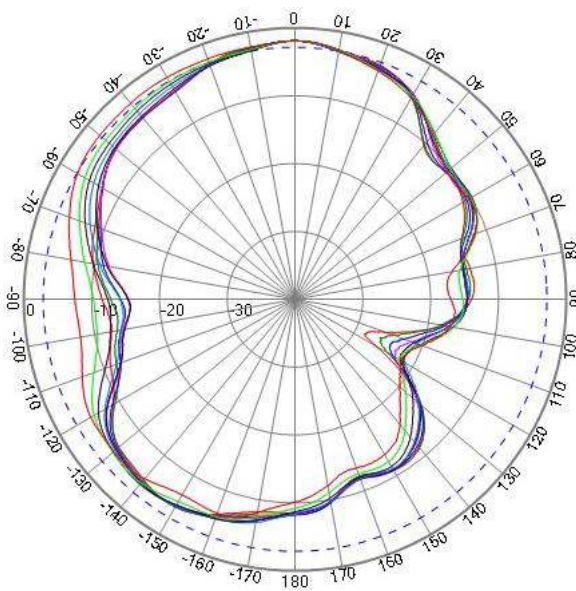

YZ PLANE

- Freq: 2400
- Freq: 2410
- Freq: 2420
- Freq: 2430
- Freq: 2440
- Freq: 2450
- Freq: 2460
- Freq: 2470
- Freq: 2483

**Revision History and Status**

Revision	Date Issued	Details	Status
<b>A</b>	Nov 4 <sup>th</sup> , 2020	Initial Release	Supported

- NIC Technical Support: [tpmg@niccomp.com](mailto:tpmg@niccomp.com)
- Compliance Support: [rohs@niccomp.com](mailto:rohs@niccomp.com)