

# OSRAM KRTBLSLPS1.32

## Datasheet

Published by **ams-OSRAM AG**

Tobelbader Strasse 30, 8141 Premstaetten, Austria

Phone +43 3136 500-0

[ams-osram.com](http://ams-osram.com)

© All rights reserved



DISPLIX® P3333

# KRTB LSLPS1.32

This device is especially designed for full color RGB applications. The 6-lead technology allows for an additive mixture of color stimuli by independent driving of each chip.



## Applications

- Entertainment
- Indoor Lighting
- Projection & Display

## Features

- Package: white PLCC-6 package, diffused silicone resin, black surface
- Chip technology: Thinfilm / UX:3 / InGaN on Sapphire
- Typ. Radiation: 120° (Lambertian emitter)
- Color:  $\lambda_{\text{dom}} = 621 \text{ nm}$  (● red);  $\lambda_{\text{dom}} = 532 \text{ nm}$  (● true green);  $\lambda_{\text{dom}} = 467 \text{ nm}$  (● blue)
- ESD: 500 V acc. to ANSI/ESDA/JEDEC JS-001 (HBM, Class 1B)

## Ordering Information

Type	Brightness <sup>1)</sup>	Ordering Code
KRTBLSLPS1.32-VUVX-EQ+BTBV-D8+TXUV-L1-B		Q65113A3080
• red	• $I_v = 800 \dots 1250 \text{ mcd}$ ( $I_F = 20 \text{ mA}$ )	
• true green	• $I_v = 1902 \dots 2800 \text{ mcd}$ ( $I_F = 20 \text{ mA}$ )	
• blue	• $I_v = 377 \dots 710 \text{ mcd}$ ( $I_F = 20 \text{ mA}$ )	

## Maximum Ratings

Parameter	Symbol		Values	Values	Values
			● red	● true green	● blue
Operating Temperature	$T_{op}$	min.	-40 °C	-40 °C	-40 °C
		max.	100 °C	100 °C	100 °C
Storage Temperature	$T_{stg}$	min.	-40 °C	-40 °C	-40 °C
		max.	100 °C	100 °C	100 °C
Junction Temperature	$T_j$	max.	125 °C	125 °C	125 °C
Forward Current $T_A = 25\text{ °C}$	$I_F$	min.	1 mA	1 mA	1 mA
		max.	40 mA	50 mA	30 mA
Forward Current pulsed $t_p = 10\ \mu s, D = 0.005, T_A = 25\text{ °C}$	$I_{F\ pulse}$		100 mA	100 mA	100 mA
Reverse voltage <sup>2)</sup> $T_A = 25\text{ °C}$	$V_R$	max.	12 V	5 V	5 V
ESD withstand voltage acc. to ANSI/ESDA/JEDEC JS-001 (HBM, Class 1B)	$V_{ESD}$		500 V	500 V	500 V

## Characteristics

$T_A = 25\text{ °C}$

Parameter	Symbol		Values	Values	Values
			● red	● true green	● blue
Peak Wavelength $I_F = 20\text{ mA}$	$\lambda_{\text{peak}}$	typ.	634 nm	526 nm	462 nm
Dominant Wavelength <sup>3)</sup> $I_F = 20\text{ mA}$	$\lambda_{\text{dom}}$	min.	616 nm	519 nm	464 nm
		typ.	621 nm	532 nm	467 nm
		max.	626 nm	546 nm	477 nm
Spectral bandwidth at 50% $I_{\text{rel,max}}$ $I_F = 20\text{ mA}$	$\Delta\lambda$	typ.	19 nm	30 nm	20 nm
Viewing angle at 50% $I_V$	$2\phi$	typ.	120 °	120 °	120 °
Forward Voltage <sup>4)</sup> $I_F = 20\text{ mA}$	$V_F$	min.	1.80 V	2.20 V	2.70 V
		typ.	2.05 V	2.65 V	2.85 V
		max.	2.40 V	3.10 V	3.40 V
Reverse current <sup>2)</sup> VR = 12V (red) / 5 V (true green / blue)	$I_R$	typ.	0.02 $\mu\text{A}$	0.01 $\mu\text{A}$	0.01 $\mu\text{A}$
		max.	10 $\mu\text{A}$	10 $\mu\text{A}$	10 $\mu\text{A}$
Real thermal resistance junction/sol- derpoint <sup>5)</sup>	$R_{\text{thJS real}}$	typ.	120 K / W	100 K / W	120 K / W
		max.	220 K / W	130 K / W	160 K / W

## Brightness Groups

- red

Group	Luminous Intensity <sup>1)</sup> $I_F = 20 \text{ mA}$ min. $I_v$	Luminous Intensity <sup>1)</sup> $I_F = 20 \text{ mA}$ max. $I_v$
VU	800 mcd	1058 mcd
VV	849 mcd	1120 mcd
VW	900 mcd	1183 mcd
VX	949 mcd	1250 mcd

## Brightness Groups

- true green

Group	Luminous Intensity <sup>1)</sup> $I_F = 20 \text{ mA}$ min. $I_v$	Luminous Intensity <sup>1)</sup> $I_F = 20 \text{ mA}$ max. $I_v$
BT	1902 mcd	2500 mcd
BU	2010 mcd	2646 mcd
BV	2122 mcd	2800 mcd

## Brightness Groups

- blue

Group	Luminous Intensity <sup>1)</sup> $I_F = 20 \text{ mA}$ min. $I_v$	Luminous Intensity <sup>1)</sup> $I_F = 20 \text{ mA}$ max. $I_v$
TX	377 mcd	500 mcd
TY	400 mcd	529 mcd
TZ	424 mcd	560 mcd
US	450 mcd	594 mcd
UT	474 mcd	630 mcd
UU	500 mcd	669 mcd
UV	529 mcd	710 mcd

## Wavelength Groups

- red

Group	Dominant Wavelength <sup>3)</sup>	Dominant Wavelength <sup>3)</sup>
	min. $\lambda_{\text{dom}}$	max. $\lambda_{\text{dom}}$
EQ	616 nm	626 nm

## Wavelength Groups

- true green

Group	Dominant Wavelength <sup>3)</sup>	Dominant Wavelength <sup>3)</sup>
	min. $\lambda_{\text{dom}}$	max. $\lambda_{\text{dom}}$
DJ	519 nm	524 nm
FL	521 nm	526 nm
JP	524 nm	529 nm
LR	526 nm	531 nm
PU	529 nm	534 nm
RW	531 nm	536 nm
U3	534 nm	541 nm
18	539 nm	546 nm

## Wavelength Groups

- blue

Group	Dominant Wavelength <sup>3)</sup>	Dominant Wavelength <sup>3)</sup>
	min. $\lambda_{\text{dom}}$	max. $\lambda_{\text{dom}}$
LS	464 nm	470 nm
PV	467 nm	473 nm
S1	470 nm	477 nm

### Chromaticity Coordinate Groups

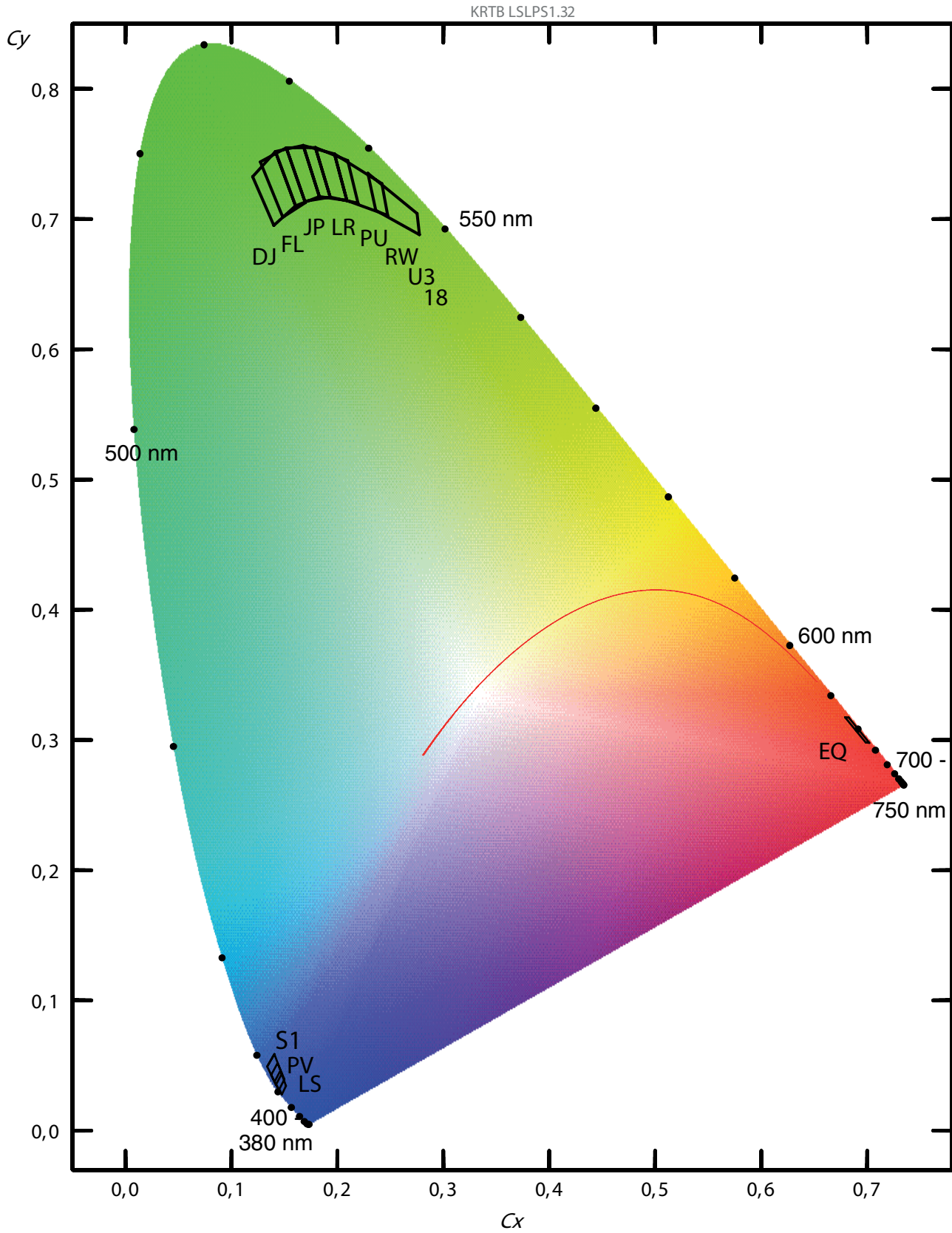



## Chromaticity Coordinate Groups

● red

Group	Cx	Cy
EQ	0.6791	0.3174
	0.6826	0.3172
	0.7022	0.2977
	0.6985	0.2981

## Chromaticity Coordinate Groups

● true green

Group	Cx	Cy
18	0.2362	0.7067
	0.2288	0.7353
	0.2752	0.7042
	0.2776	0.6881
DJ	0.1401	0.6951
	0.1201	0.7325
	0.1415	0.7518
	0.1606	0.7102
FL	0.1486	0.7014
	0.1273	0.7439
	0.1517	0.7547
	0.1698	0.7127
JP	0.1606	0.7102
	0.1415	0.7518
	0.1679	0.7565
	0.1831	0.7174
LR	0.1694	0.7136
	0.1517	0.7547
	0.1794	0.7549
	0.1933	0.7170
PU	0.1831	0.7174
	0.1678	0.7565
	0.1973	0.7500
	0.2091	0.7142

## Chromaticity Coordinate Groups

- true green

Group	Cx	Cy
RW	0.1932	0.7170
	0.1794	0.7549
	0.2098	0.7449
	0.2196	0.7122
U3	0.2091	0.7142
	0.1974	0.7500
	0.2419	0.7273
	0.2474	0.7029

## Chromaticity Coordinate Groups

- blue

Group	Cx	Cy
LS	0.1452	0.0492
	0.1391	0.0401
	0.1273	0.0619
	0.1354	0.0727
PV	0.1405	0.0588
	0.1338	0.0493
	0.1199	0.0785
	0.1295	0.0899
S1	0.1354	0.0727
	0.1273	0.0619
	0.1085	0.1086
	0.1203	0.1204

### Relative Spectral Emission <sup>6)</sup>

$I_{rel} = f(\lambda); I_F = 20 \text{ mA}; T_S = 25 \text{ }^\circ\text{C}$

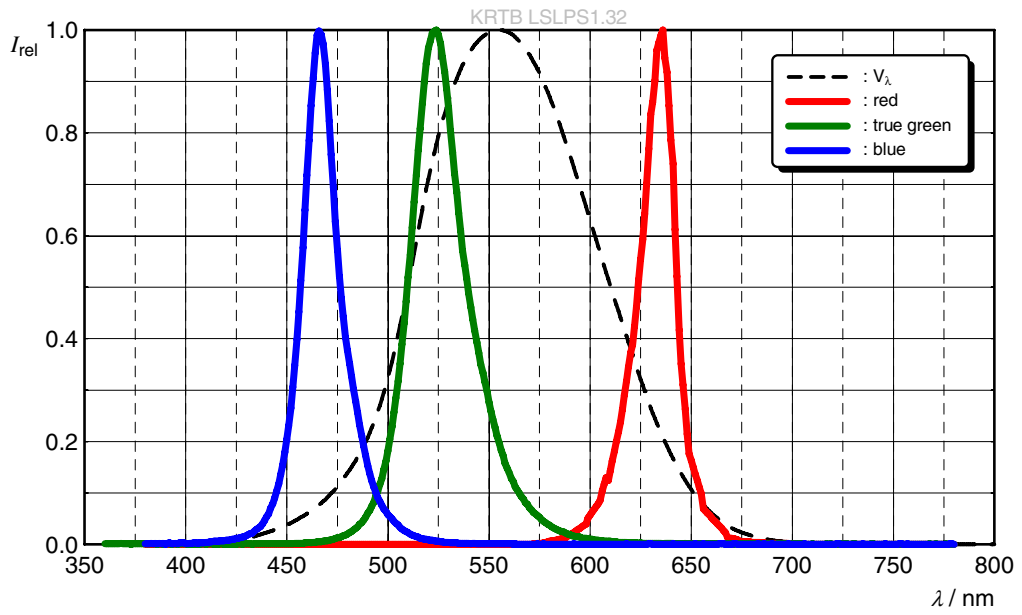

### Radiation Characteristic (horizontal) <sup>6)</sup>

$I_{rel} = f(\lambda)$ ;  $I_F = 20 \text{ mA}$ ;  $T_S = 25 \text{ }^\circ\text{C}$

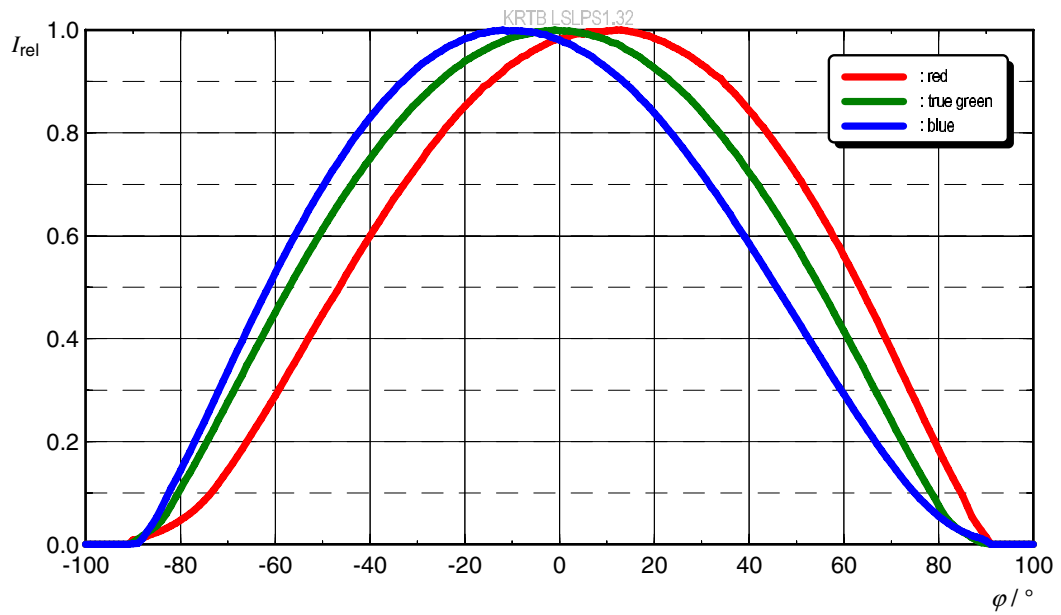

### Radiation Characteristic (vertical) <sup>6)</sup>

$I_{rel} = f(\lambda)$ ;  $I_F = 20 \text{ mA}$ ;  $T_S = 25 \text{ }^\circ\text{C}$

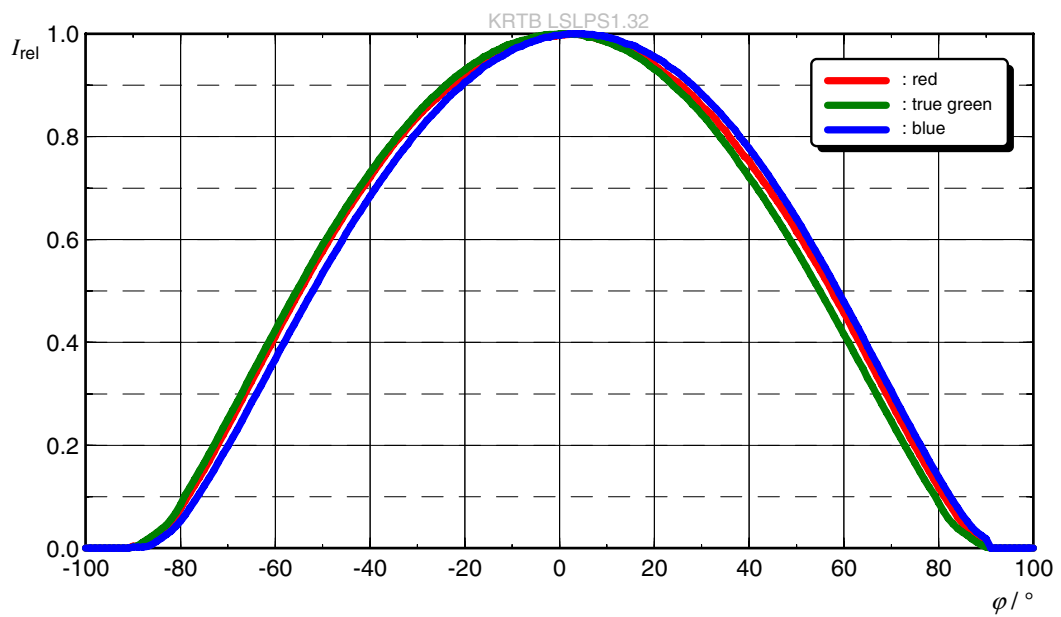

**Forward current** 6), 7)

$I_F = f(V_F); T_S = 25\text{ °C}$

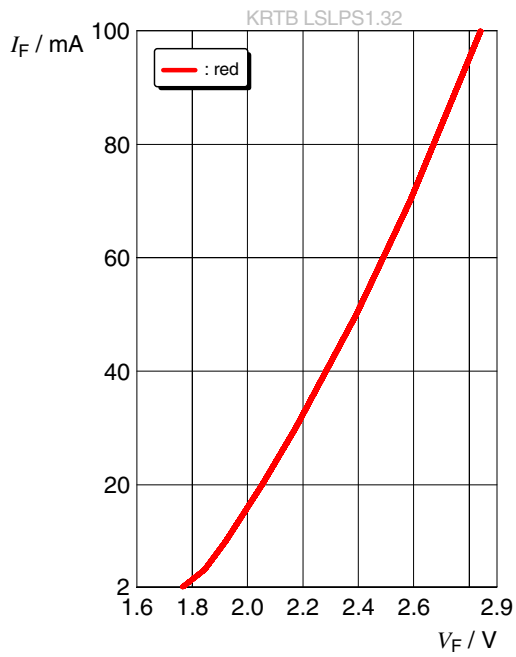

**Forward current** 6), 7)

$I_F = f(V_F); T_S = 25\text{ °C}$

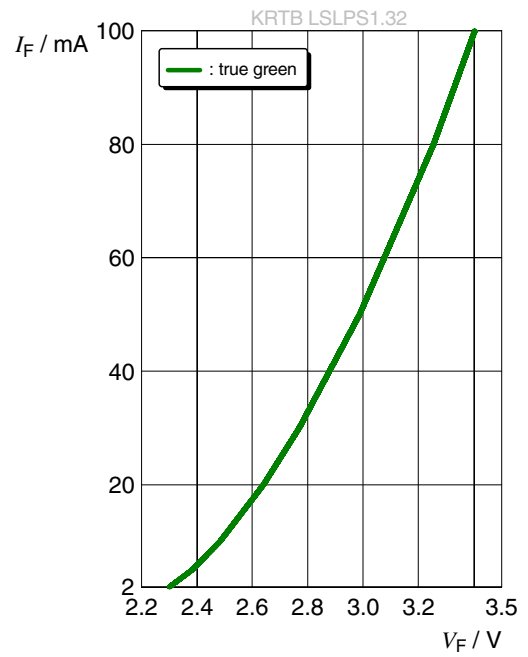

**Forward current** 6), 7)

$I_F = f(V_F); T_S = 25\text{ °C}$

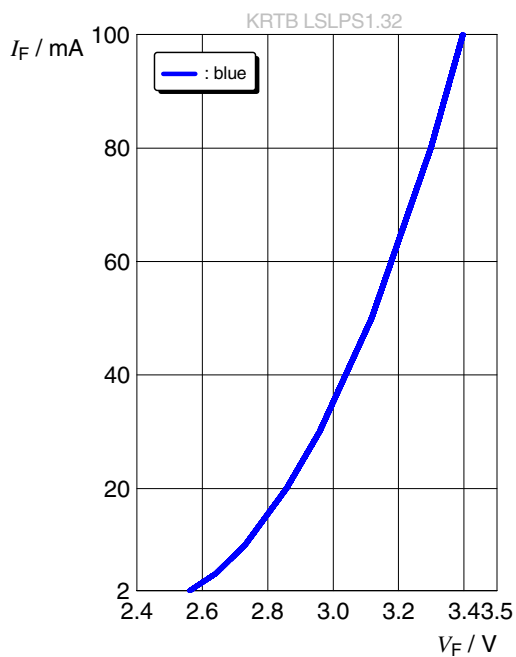

### Relative Luminous Intensity <sup>6), 7)</sup>

$$I_V/I_V(20\text{ mA}) = f(I_F); T_S = 25\text{ °C}$$

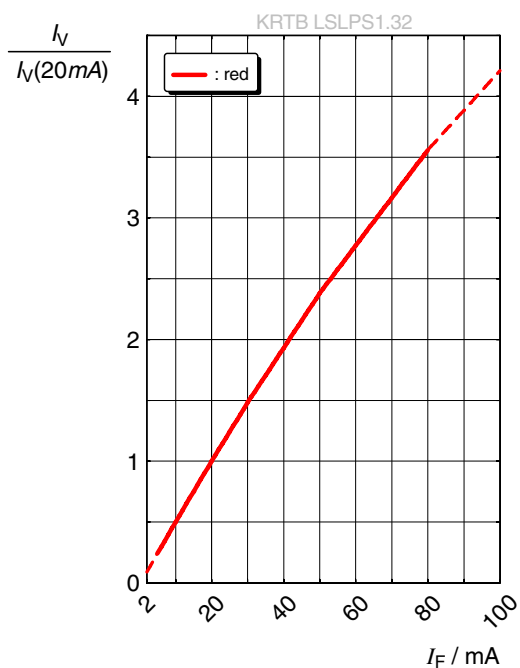

### Relative Luminous Intensity <sup>6), 7)</sup>

$$I_V/I_V(20\text{ mA}) = f(I_F); T_S = 25\text{ °C}$$

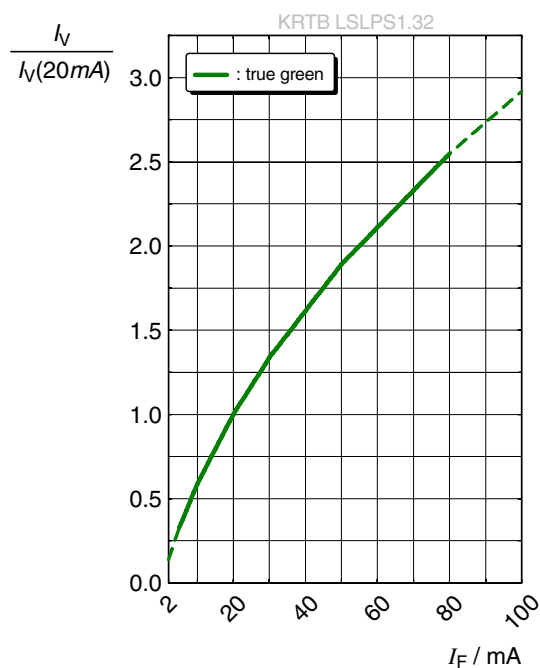

### Relative Luminous Intensity <sup>6), 7)</sup>

$$I_V/I_V(20\text{ mA}) = f(I_F); T_S = 25\text{ °C}$$

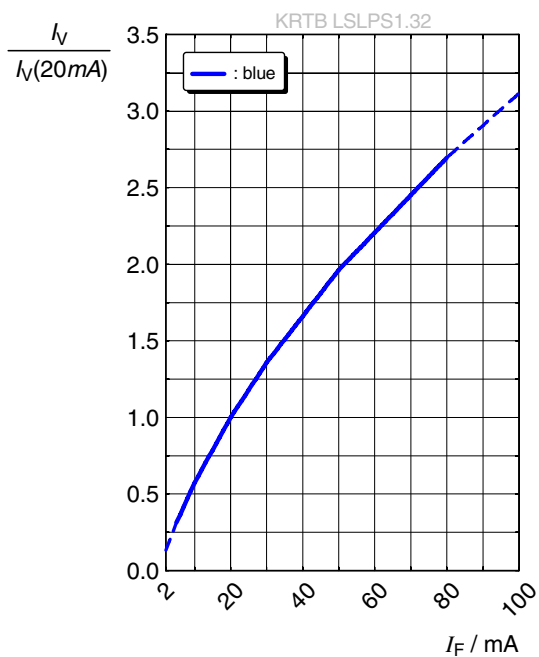

### Dominant Wavelength <sup>6)</sup>

$$\lambda_{\text{dom}} = f(I_F); T_S = 25 \text{ }^\circ\text{C}$$

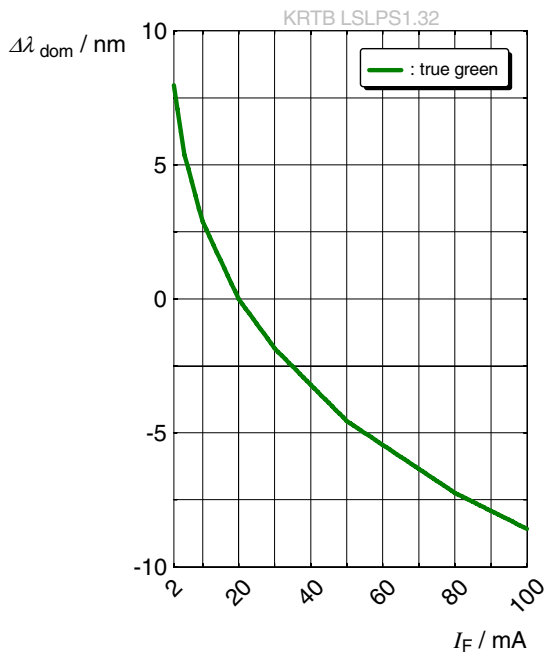

### Dominant Wavelength <sup>6)</sup>

$$\lambda_{\text{dom}} = f(I_F); T_S = 25 \text{ }^\circ\text{C}$$

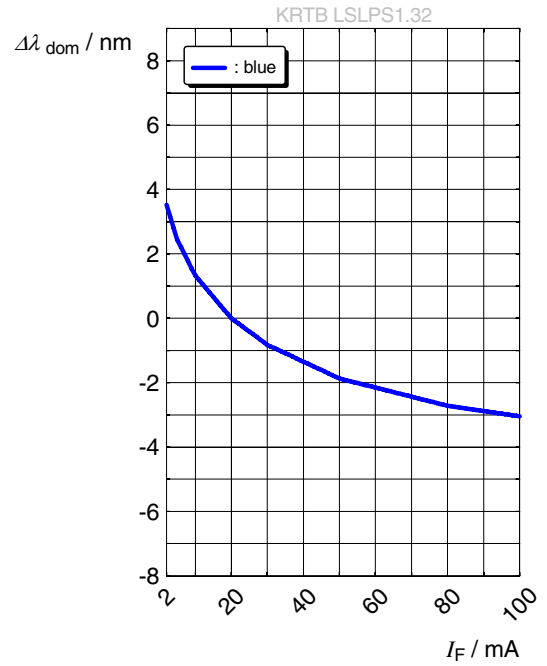

### Forward Voltage <sup>6)</sup>

$$\Delta V_F = V_F - V_F(25\text{ }^\circ\text{C}) = f(T_j); I_F = 20\text{ mA}$$

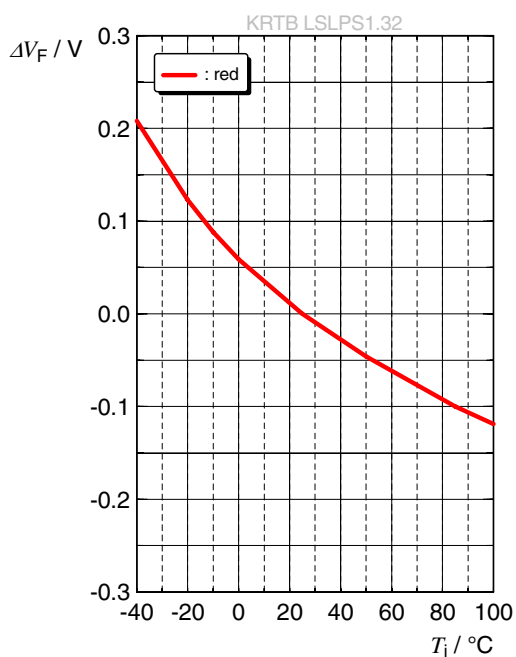

### Forward Voltage <sup>6)</sup>

$$\Delta V_F = V_F - V_F(25\text{ }^\circ\text{C}) = f(T_j); I_F = 20\text{ mA}$$

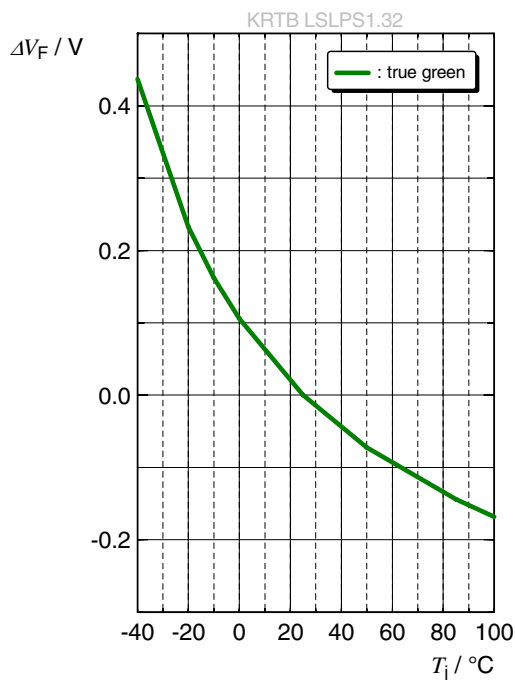

### Forward Voltage <sup>6)</sup>

$$\Delta V_F = V_F - V_F(25\text{ }^\circ\text{C}) = f(T_j); I_F = 20\text{ mA}$$

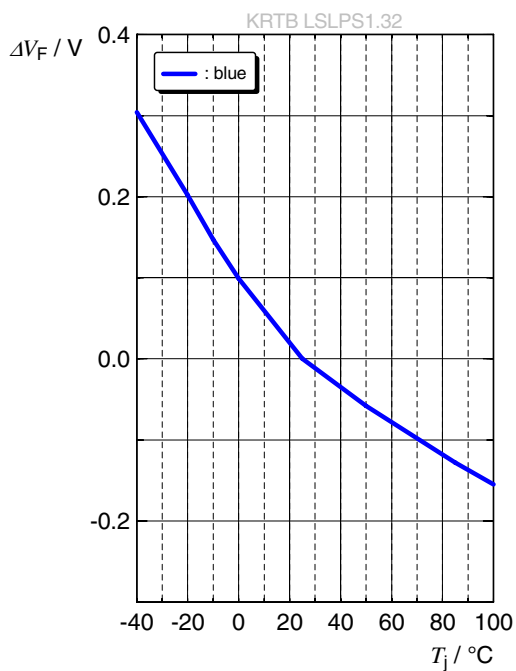



### Relative Luminous Intensity <sup>6)</sup>

$$I_v/I_v(25\text{ °C}) = f(T_j); I_F = 20\text{ mA}$$

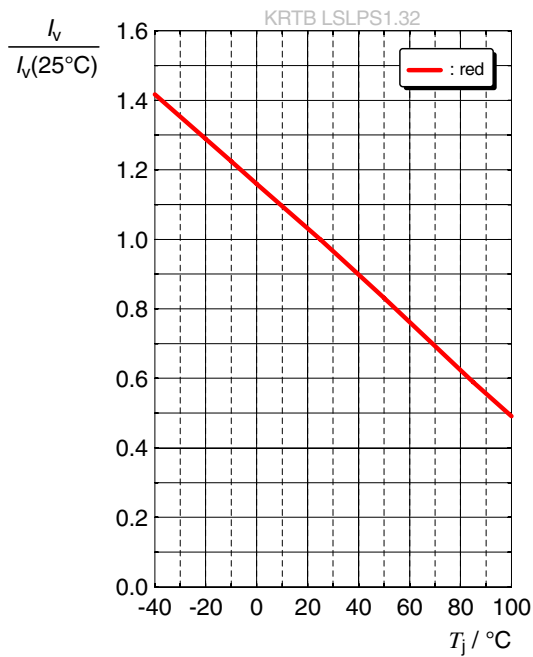

### Relative Luminous Intensity <sup>6)</sup>

$$I_v/I_v(25\text{ °C}) = f(T_j); I_F = 20\text{ mA}$$

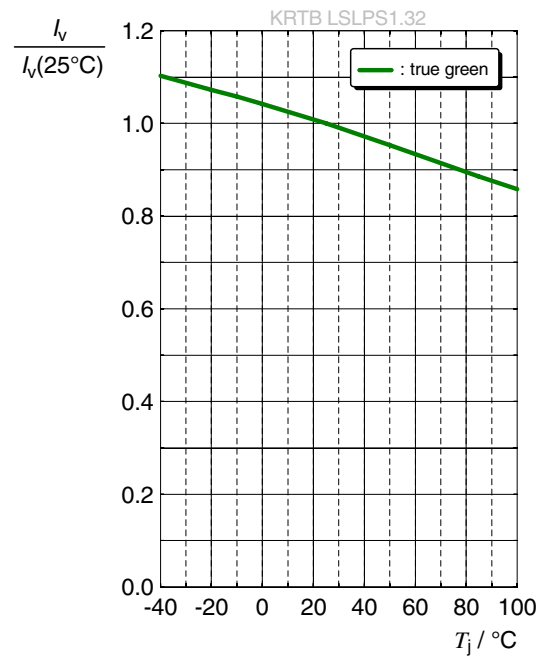

### Relative Luminous Intensity <sup>6)</sup>

$$I_v/I_v(25\text{ °C}) = f(T_j); I_F = 20\text{ mA}$$

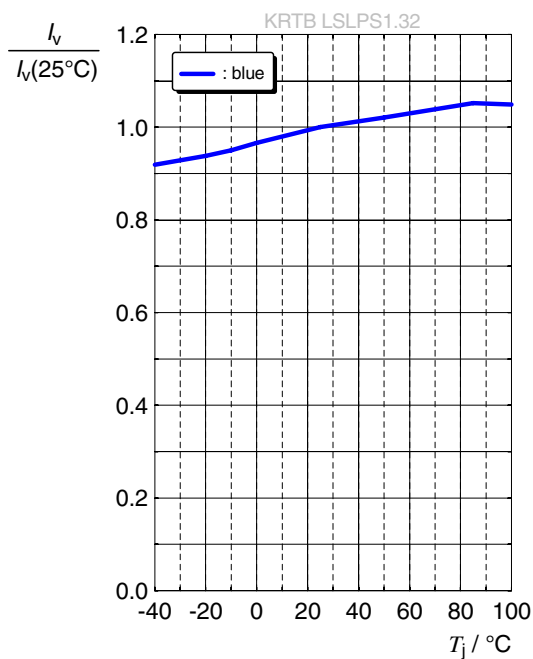

### Dominant Wavelength <sup>6)</sup>

$$\Delta\lambda_{\text{dom}} = \lambda_{\text{dom}} - \lambda_{\text{dom}}(25\text{ °C}) = f(T_j); I_F = 20\text{ mA}$$

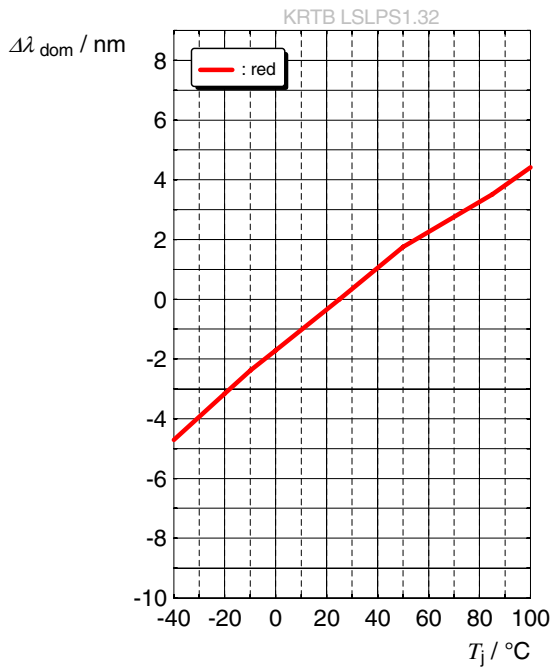

### Dominant Wavelength <sup>6)</sup>

$$\Delta\lambda_{\text{dom}} = \lambda_{\text{dom}} - \lambda_{\text{dom}}(25\text{ °C}) = f(T_j); I_F = 20\text{ mA}$$

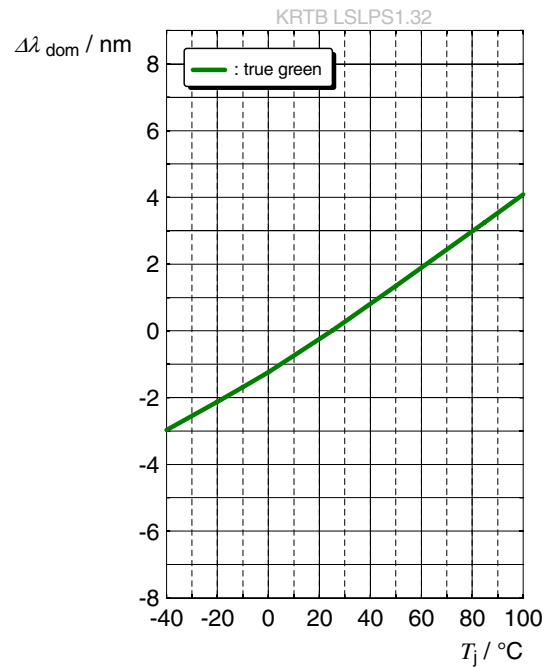

### Dominant Wavelength <sup>6)</sup>

$$\Delta\lambda_{\text{dom}} = \lambda_{\text{dom}} - \lambda_{\text{dom}}(25\text{ °C}) = f(T_j); I_F = 20\text{ mA}$$

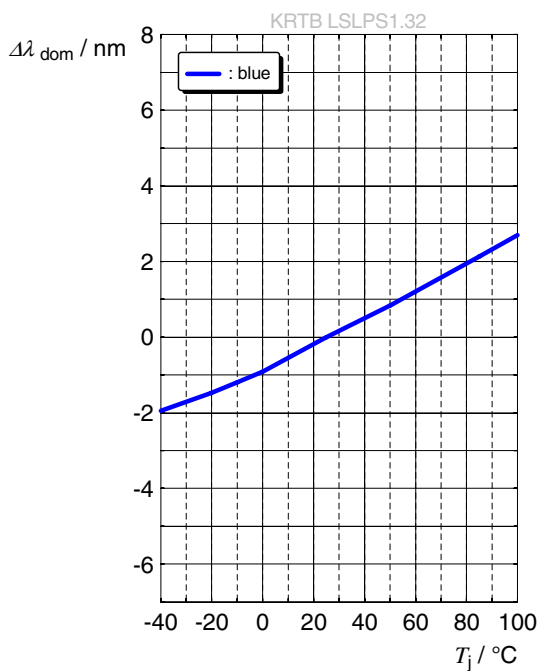

### Max. Permissible Forward Current

$I_F = f(T)$ ; ● red

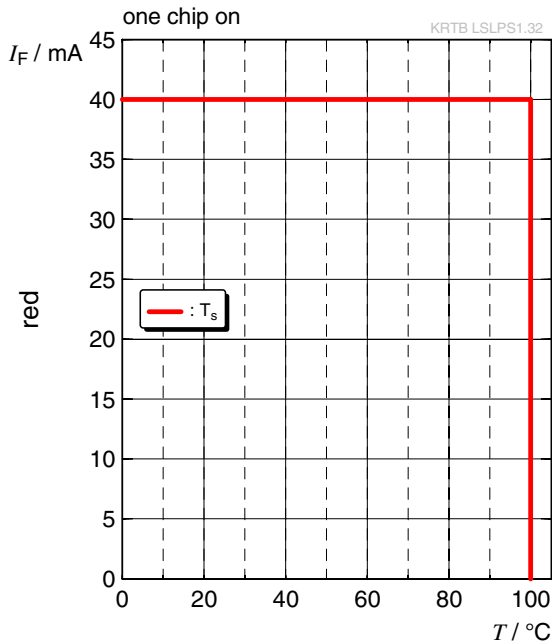

### Max. Permissible Forward Current

$I_F = f(T)$ ; ● true green

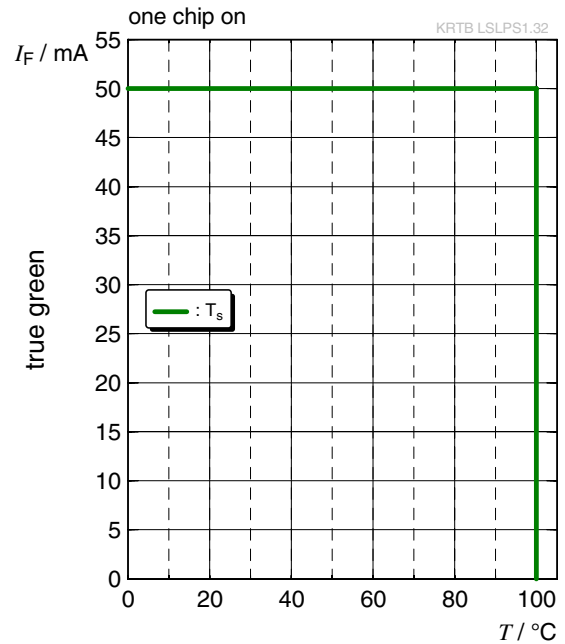

### Max. Permissible Forward Current

$I_F = f(T)$ ; ● blue

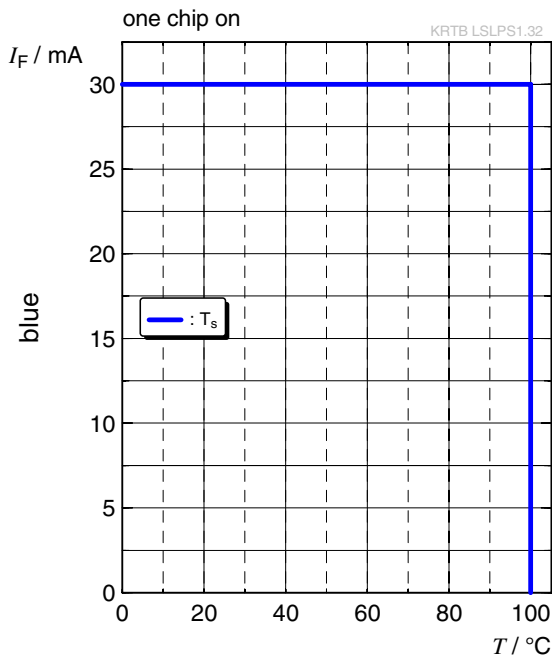

### Permissible Pulse Handling Capability

$I_F = f(T)$ ; ● red

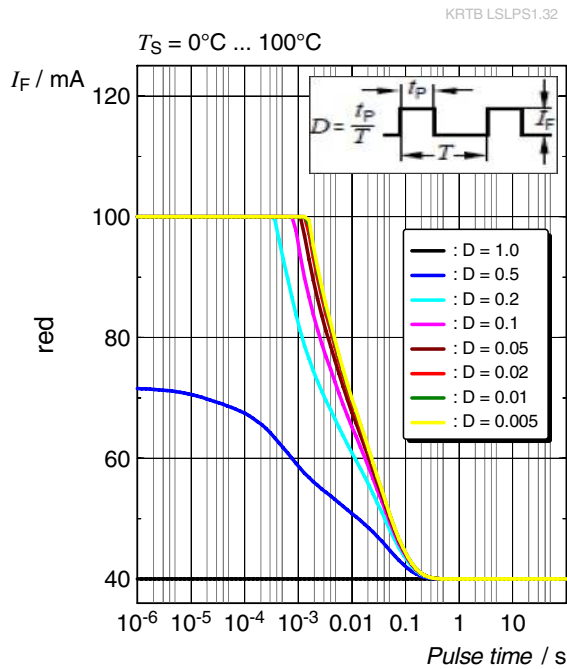

### Permissible Pulse Handling Capability

$I_F = f(T)$ ; ● true green

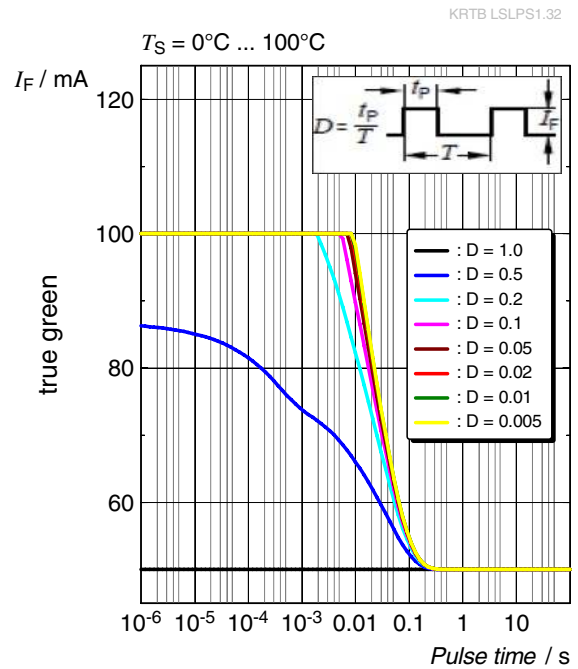

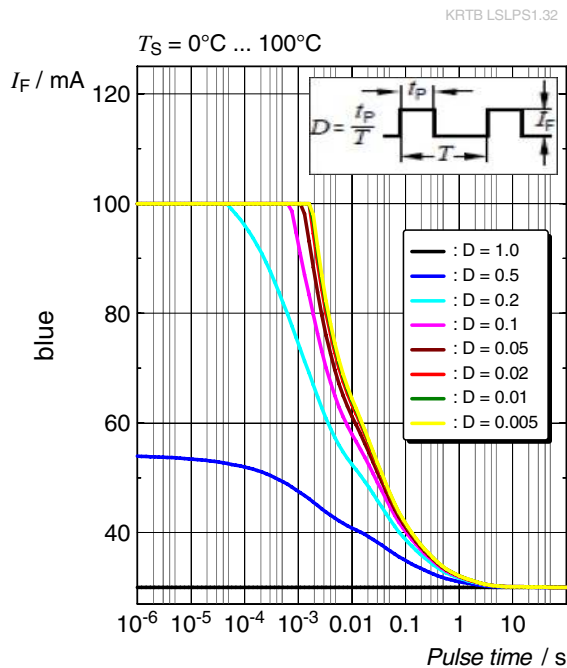

### Max. Permissible Forward Current

$I_F = f(T)$ ; ● blue

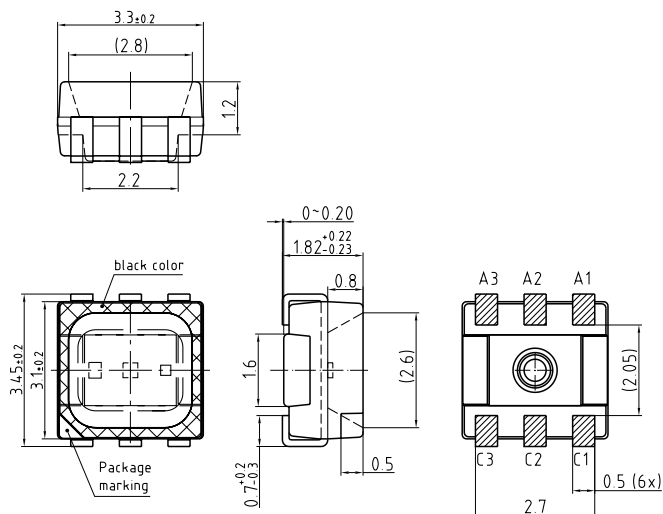

## Dimensional Drawing <sup>8)</sup>



General tolerance  $\pm 0.1$   
 lead finished Ag

C67062-A0226-A2-03

## Further Information:

**Approximate Weight:** 34.0 mg

**Notes:** Package not suitable for ultra sonic cleaning.

Pin	Description
C1	Cathode (Blue)
A1	Anode (Blue)
C2	Cathode (True Green)
A2	Anode (True Green)
C3	Cathode (Red)
A3	Anode (Red)

Recommended Solder Pad <sup>8)</sup>

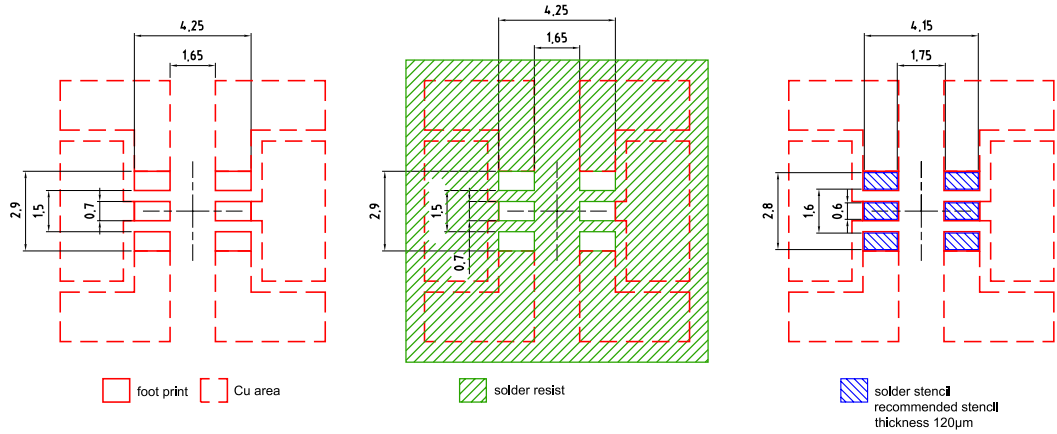

Component Location on Pad

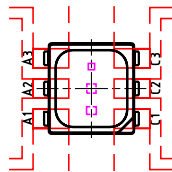

E062.3010.124 -04

For superior solder joint connectivity results we recommend soldering under standard nitrogen atmosphere.

## Reflow Soldering Profile

Product complies to MSL Level 4 acc. to JEDEC J-STD-020E

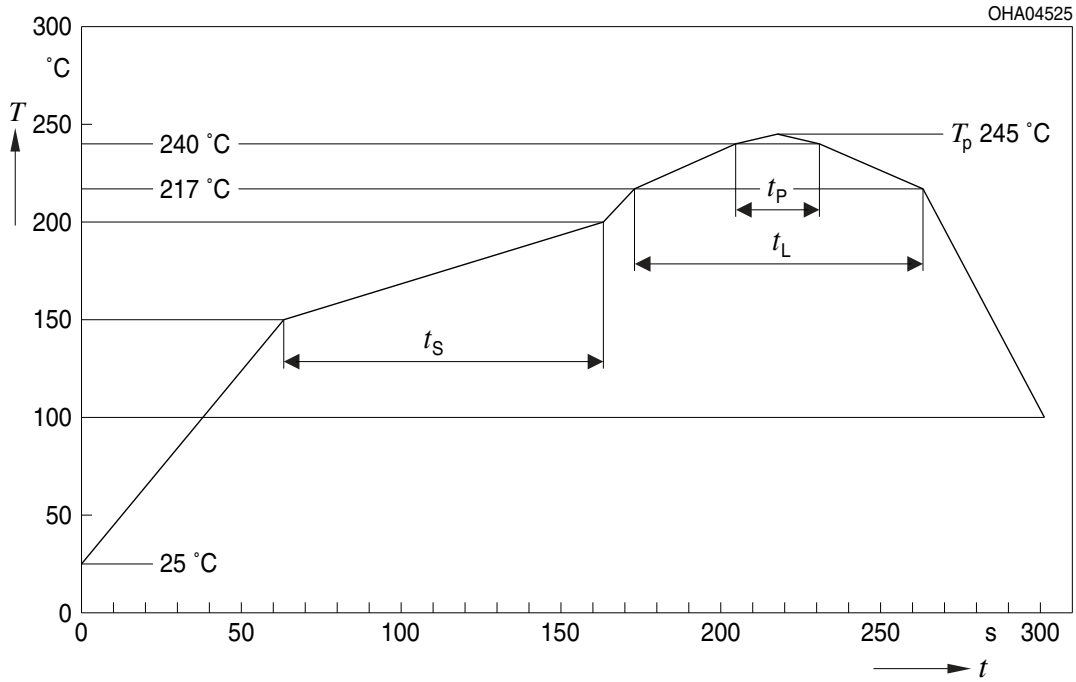

Profile Feature	Symbol	Pb-Free (SnAgCu) Assembly			Unit
		Minimum	Recommendation	Maximum	
Ramp-up rate to preheat <sup>*)</sup> 25 °C to 150 °C			2	3	K/s
Time $t_s$ $T_{Smin}$ to $T_{Smax}$	$t_s$	60	100	120	s
Ramp-up rate to peak <sup>*)</sup> $T_{Smax}$ to $T_p$			2	3	K/s
Liquidus temperature	$T_L$		217		°C
Time above liquidus temperature	$t_L$		80	100	s
Peak temperature	$T_p$		245	260	°C
Time within 5 °C of the specified peak temperature $T_p - 5$ K	$t_p$	10	20	30	s
Ramp-down rate* $T_p$ to 100 °C			3	6	K/s
Time 25 °C to $T_p$				480	s

All temperatures refer to the center of the package, measured on the top of the component  
 \*) slope calculation  $DT/Dt$ :  $Dt$  max. 5 s; fulfillment for the whole T-range

Taping <sup>8)</sup>

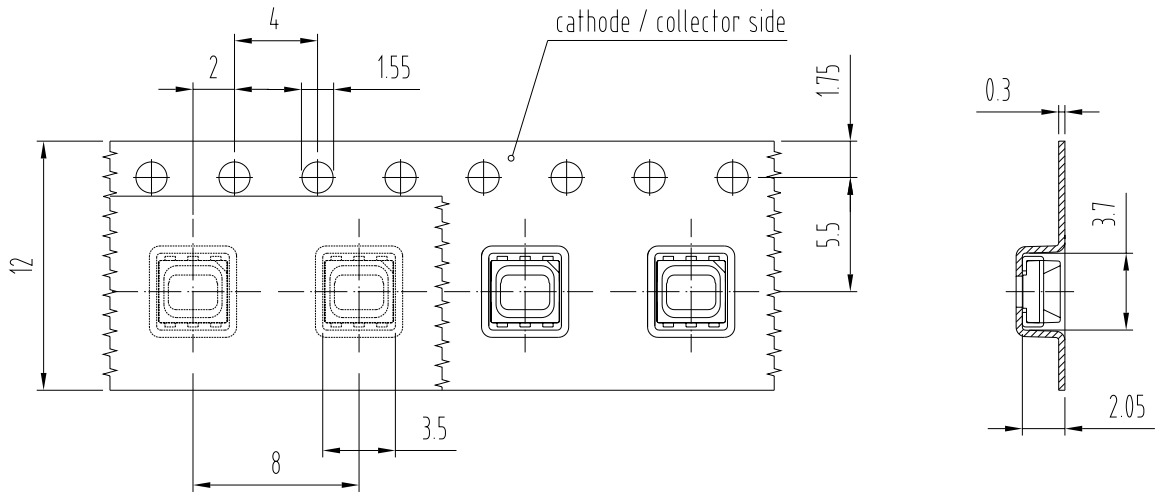

C67062-A0226-B9-01



**Tape and Reel** <sup>9)</sup>

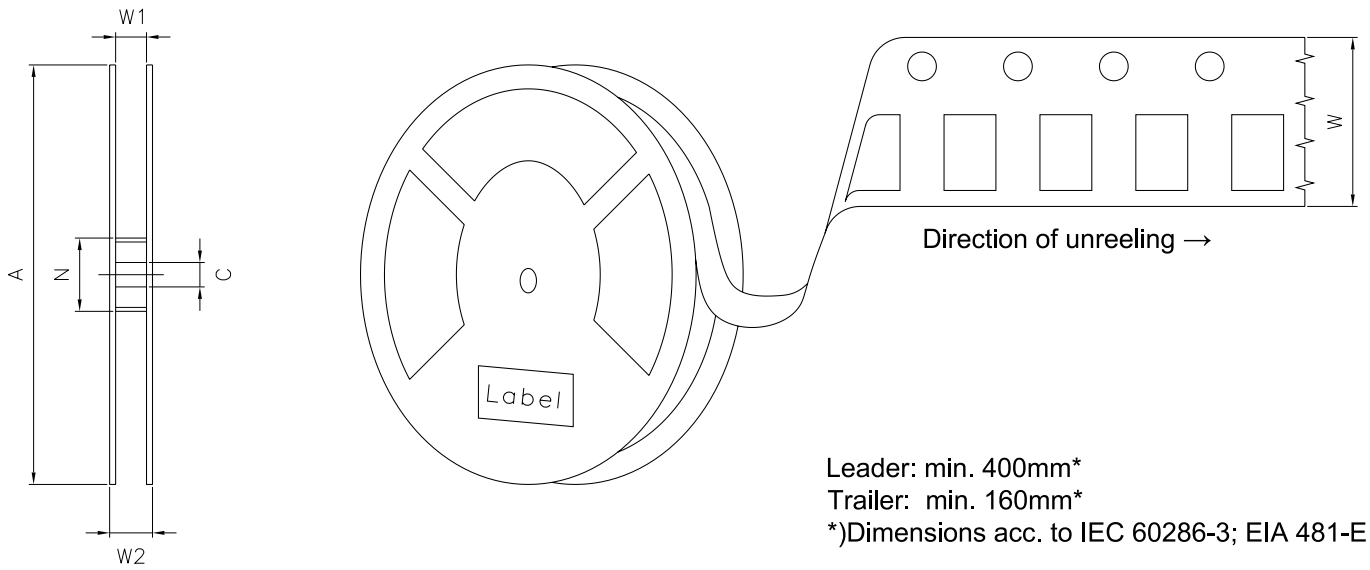

**Reel Dimensions**

A	W	N <sub>min</sub>	W <sub>1</sub>	W <sub>2max</sub>	Pieces per PU
330 mm	12 + 0.3 / - 0.1 mm	60 mm	12.4 + 2 mm	18.4 mm	4000

### Barcode-Product-Label (BPL)

**OSRAM Opto Semiconductors** LX XXXX BIN1: XX-XX-X-XXX-X

RoHS Compliant

(6P) BATCH NO: 1234567890

(1T) LOT NO: 1234567890 (9D) D/C: 1234

(X) PROD NO: 123456789(Q)QTY: 9999 (G) GROUP: XX-XX-X-X

ML Temp ST  
X XXX °C X

Pack: RXX  
DEMY XXX  
X\_X123\_1234.1234 X

The diagram shows a rectangular label with rounded corners. It contains the OSRAM logo and product name at the top left. To the right are fields for 'LX XXXX' and 'BIN1: XX-XX-X-XXX-X'. Below this is 'RoHS Compliant'. The main body of the label features three rows of information, each with a corresponding barcode: '(6P) BATCH NO: 1234567890', '(1T) LOT NO: 1234567890 (9D) D/C: 1234', and '(X) PROD NO: 123456789(Q)QTY: 9999 (G) GROUP: XX-XX-X-X'. To the right of the second row is a 'No moisture' symbol (a circle with a diagonal line and three drops) and 'ML Temp ST X XXX °C X'. Below that is 'Pack: RXX', 'DEMY XXX', and 'X\_X123\_1234.1234 X'. A QR code is located on the right side of the label.

OHA04563

### Dry Packing Process and Materials <sup>8)</sup>

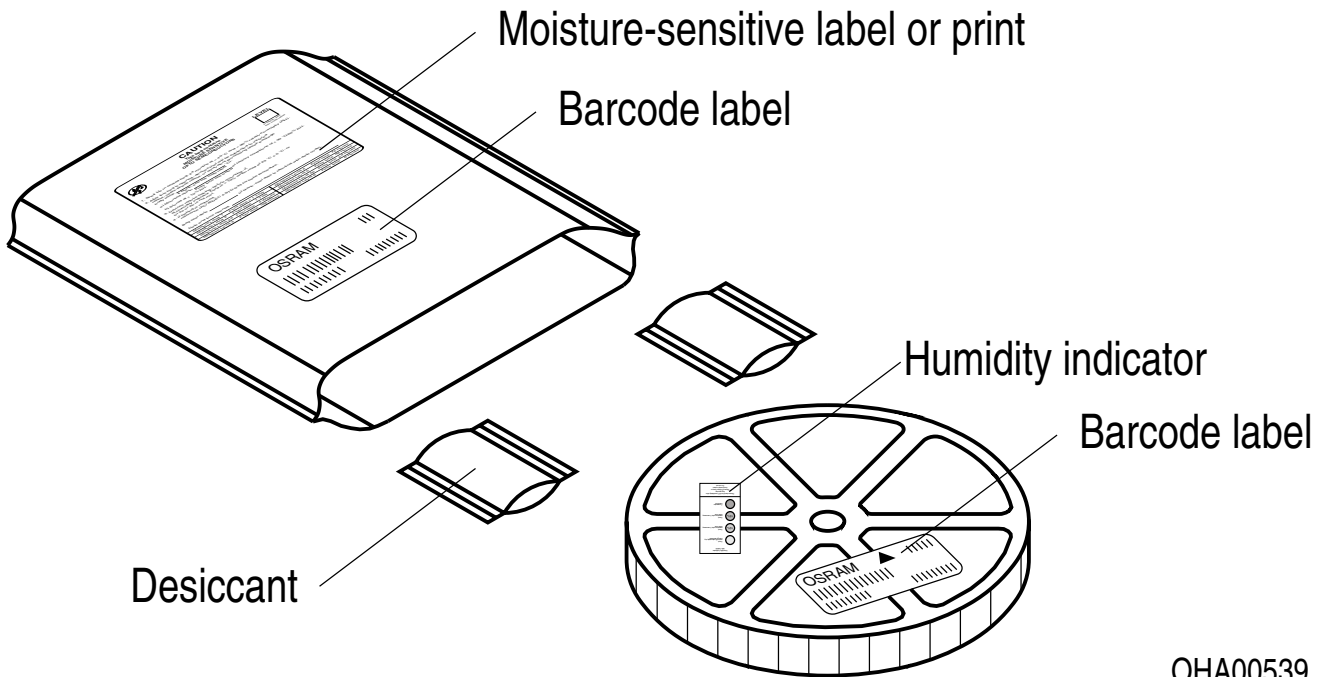

OHA00539

Moisture-sensitive product is packed in a dry bag containing desiccant and a humidity card according JEDEC-STD-033.

---

## Notes

The evaluation of eye safety occurs according to the standard IEC 62471:2006 (photo biological safety of lamps and lamp systems). Within the risk grouping system of this IEC standard, the device specified in this data sheet fall into the class **exempt group (exposure time 10000 s)**. Under real circumstances (for exposure time, conditions of the eye pupils, observation distance), it is assumed that no endangerment to the eye exists from these devices. As a matter of principle, however, it should be mentioned that intense light sources have a high secondary exposure potential due to their blinding effect. When looking at bright light sources (e.g. headlights), temporary reduction in visual acuity and afterimages can occur, leading to irritation, annoyance, visual impairment, and even accidents, depending on the situation.

Subcomponents of this device contain, in addition to other substances, metal filled materials including silver. Metal filled materials can be affected by environments that contain traces of aggressive substances. Therefore, we recommend that customers minimize device exposure to aggressive substances during storage, production, and use. Devices that showed visible discoloration when tested using the described tests above did show no performance deviations within failure limits during the stated test duration. Respective failure limits are described in the IEC60810.

For further application related information please visit [www.osram-os.com/appnotes](http://www.osram-os.com/appnotes)

## Disclaimer

### Attention please!

The information describes the type of component and shall not be considered as assured characteristics. Terms of delivery and rights to change design reserved. Due to technical requirements components may contain dangerous substances.

For information on the types in question please contact our Sales Organization.

If printed or downloaded, please find the latest version on our website.

### Packing

Please use the recycling operators known to you. We can also help you – get in touch with your nearest sales office. By agreement we will take packing material back, if it is sorted. You must bear the costs of transport. For packing material that is returned to us unsorted or which we are not obliged to accept, we shall have to invoice you for any costs incurred.

### Product and functional safety devices/applications or medical devices/applications

Our components are not developed, constructed or tested for the application as safety relevant component or for the application in medical devices.

Our products are not qualified at module and system level for such application.

In case buyer – or customer supplied by buyer – considers using our components in product safety devices/ applications or medical devices/applications, buyer and/or customer has to inform our local sales partner immediately and we and buyer and /or customer will analyze and coordinate the customer-specific request between us and buyer and/or customer.

---

## Glossary

- 1) **Brightness:** Brightness values are measured during a current pulse of typically 25 ms, with an internal reproducibility of  $\pm 8\%$  and an expanded uncertainty of  $\pm 11\%$  (acc. to GUM with a coverage factor of  $k = 3$ ).
- 2) **Reverse Operation:** This product is intended to be operated applying a forward current within the specified range. Applying any continuous reverse bias or forward bias below the voltage range of light emission shall be avoided because it may cause migration which can change the electro-optical characteristics or damage the LED.
- 3) **Wavelength:** The wavelength is measured at a current pulse of typically 25 ms, with an internal reproducibility of  $\pm 0.5$  nm and an expanded uncertainty of  $\pm 1$  nm (acc. to GUM with a coverage factor of  $k = 3$ ).
- 4) **Forward Voltage:** Forward voltages are tested at a current pulse duration of 1 ms and a tolerance of  $\pm 0.05$  V and an expanded uncertainty of  $\pm 0.1$  V (acc. to GUM with a coverage factor of  $k = 3$ ).
- 5) **Thermal Resistance:**  $R_{th\ max}$  is based on statistic values ( $6\sigma$ ).
- 6) **Typical Values:** Due to the special conditions of the manufacturing processes of semiconductor devices, the typical data or calculated correlations of technical parameters can only reflect statistical figures. These do not necessarily correspond to the actual parameters of each single product, which could differ from the typical data and calculated correlations or the typical characteristic line. If requested, e.g. because of technical improvements, these typ. data will be changed without any further notice.
- 7) **Characteristic curve:** In the range where the line of the graph is broken, you must expect higher differences between single devices within one packing unit.
- 8) **Tolerance of Measure:** Unless otherwise noted in drawing, tolerances are specified with  $\pm 0.1$  and dimensions are specified in mm.
- 9) **Tape and Reel:** All dimensions and tolerances are specified acc. IEC 60286-3 and specified in mm.



EU RoHS and China RoHS compliant product

此产品符合欧盟 RoHS 指令的要求；  
按照中国的相关法规和标准，  
不含有毒有害物质或元素。

**Published by ams-OSRAM AG**

Tobelbader Strasse 30, 8141 Premstaetten, Austria

Phone +43 3136 500-0

[ams-osram.com](http://ams-osram.com)

© All rights reserved

**am** 

**OSRAM**