

SERIES: PSK-60D | **DESCRIPTION:** INTERNAL AC-DC POWER SUPPLY
FEATURES

- 50~60 W output power
- certified to IEC/UL/EN 62368
- designed to meet IEC/EN 60335, IEC/EN 62477 and EN61558
- meets Class B emissions and +/- 2kV surge without external circuits
- universal 85-305Vac or 100-430Vdc input voltage
- operating ambient temperature range: -40°C ~ 85°C with derating
- output short circuit, over-current, and over-voltage protection
- input OVC III protection
- 5,000m operating altitude

**MODEL**

MODEL	output voltage	output current	output power	ripple and noise ¹	efficiency ²
	(Vdc)	max (A)	max (W)	max (mVp-p)	typ (%)
PSK-60D-5	5	10.0	50	150	89
PSK-60D-12	12	5.0	60	150	91
PSK-60D-15	15	4.0	60	150	90
PSK-60D-24	24	2.5	60	150	90
PSK-60D-48	48	1.25	60	150	91

Notes: 1. At full load, nominal input, 20 MHz bandwidth oscilloscope, with 1 μ F ceramic and 47 μ F electrolytic capacitors on the output.
 2. At 230 Vac input.
 3. All specifications are measured at Ta=25°C, humidity <75%, nominal input voltage, and rated output load unless otherwise specified.

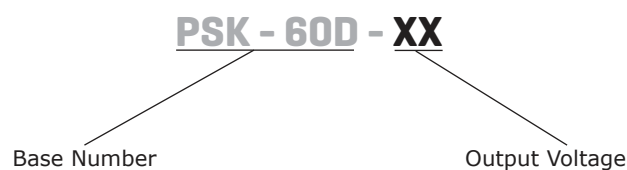
PART NUMBER KEY

INPUT

parameter	conditions/description	min	typ	max	units
voltage	ac input	85		305	Vac
	dc input	100		430	Vdc
frequency		47		63	Hz
current	115 Vac			1.8	A
	230 Vac			1.0	A
inrush current	115 Vac		30		A
	230 Vac		60		A
leakage current	277 Vac/50 Hz			0.25	mA
external input fuse	3.15A/300V, slow-blow, required				
no load power consumption			0.3	0.45	W

OUTPUT

parameter	conditions/description	min	typ	max	units
capacitive load	5 Vdc output model			20,000	μF
	12 Vdc output model			5,000	μF
	15 Vdc output model			3,000	μF
	24 Vdc output model			1,800	μF
	48 Vdc output model			470	μF
output voltage accuracy			±2		%
line regulation	at full load		±1		%
load regulation	0~100% load		±1.5		%
hold-up time	115 Vac		8		ms
	230 Vac		65		ms
temperature coefficient			±0.02		%/°C

PROTECTIONS

parameter	conditions/description	min	typ	max	units
over voltage protection	latch-off				
	5 Vdc output			9	Vdc
	12 Vdc output			16	Vdc
	15 Vdc output			25	Vdc
	24 Vdc output			35	Vdc
	48 Vdc output			60	Vdc
over current protection	auto recovery	140			%
short circuit protection	continuous, auto recovery, hiccup				

SAFETY & COMPLIANCE

parameter	conditions/description	min	typ	max	units
isolation voltage	input to output for 1 min., 5mA max	4,200			Vac
insulation resistance	input to output at 500 Vdc	100			MΩ
safety approvals	certified to 62368: UL, IEC, EN				
safety class	Class II				
conducted emissions	CISPR32/EN55032 Class B				
radiated emissions	CISPR32/EN55032 Class B				
ESD	IEC/EN61000-4-2 Contact ±6KV/Air ±8KV, perf. Criteria A				
radiated immunity	IEC/EN61000-4-3 10V/m, perf. Criteria A				
EFT/burst	IEC/EN61000-4-4 ±2KV, perf. Criteria A				
	IEC/EN61000-4-4 ±4KV (See recommended circuit), perf. Criteria A				
surge	IEC/EN61000-4-5 line to line ±2KV, perf. Criteria A				
	IEC/EN61000-4-5 line to line ±2KV/line to PE ±4KV (See recommended circuit), perf. Criteria A				
conducted immunity	IEC/EN61000-4-6 10Vrms, perf. Criteria A				

SAFETY & COMPLIANCE

parameter	conditions/description	min	typ	max	units
voltage dips and interruption	IEC/EN61000-4-11 0%, 70% perf. Criteria B				
MTBF	MIL-HDBK-217F at 25°C	500,000			hours
RoHS	yes				

ENVIRONMENTAL

parameter	conditions/description	min	typ	max	units
operating temperature		-40		85	°C
storage temperature		-40		85	°C
storage humidity		0		95	%

SOLDERABILITY

parameter	conditions/description	min	typ	max	units
wave soldering	10 seconds max	255	260	265	°C
hand soldering	5 seconds max	350	360	370	°C

MECHANICAL

parameter	conditions/description	min	typ	max	units
dimensions	70.00 x 48.00 x 27.00				mm
weight			130		g
case material	black plastic, flame-retardant and heat-resistant (UL94V-0)				
cooling method	natural convection				

MECHANICAL DRAWING

units: mm [inch]
 pin diameter tolerance: ± 0.10 [± 0.004]
 tolerance: ± 0.50 [± 0.020]

PIN CONNECTIONS	
PIN	Function
1	AC(N)
2	AC(L)
3	-Vo
4	+Vo

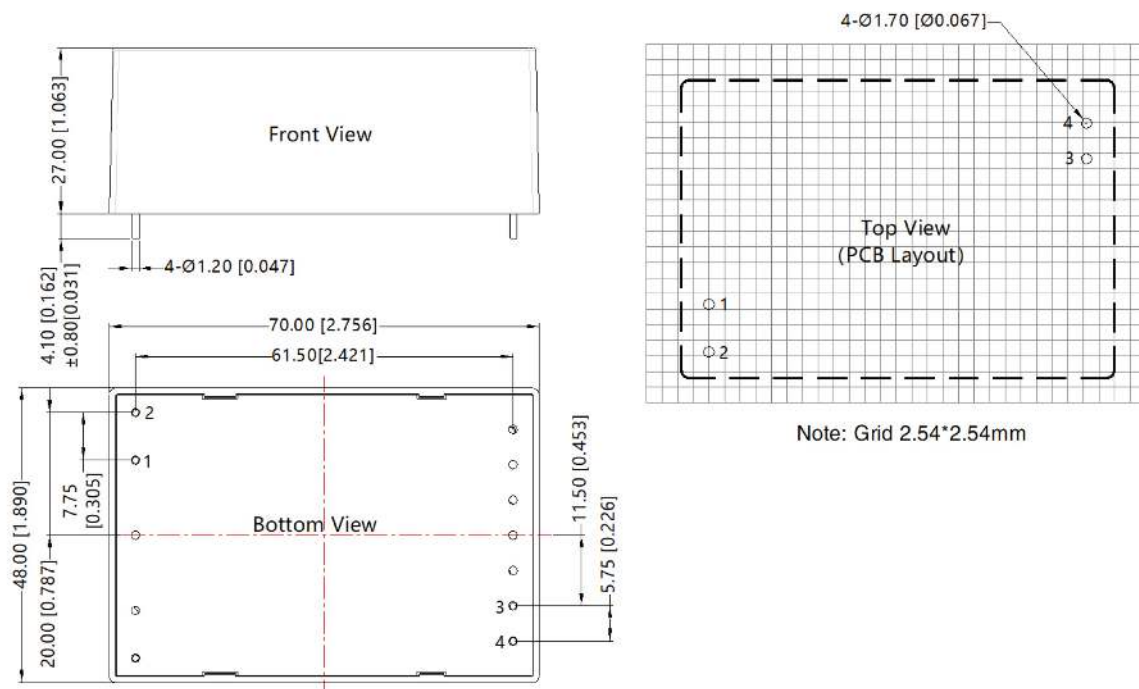

DERATING CURVE

TEMPERATURE DERATING CURVE
85~305 Vac
100~430 Vdc

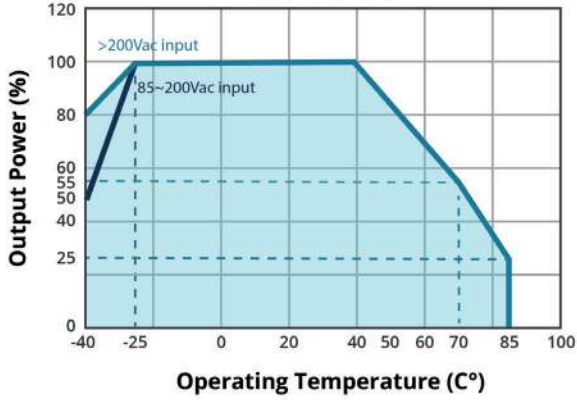

TEMPERATURE DERATING CURVE
85~305 Vac
100~430 Vdc

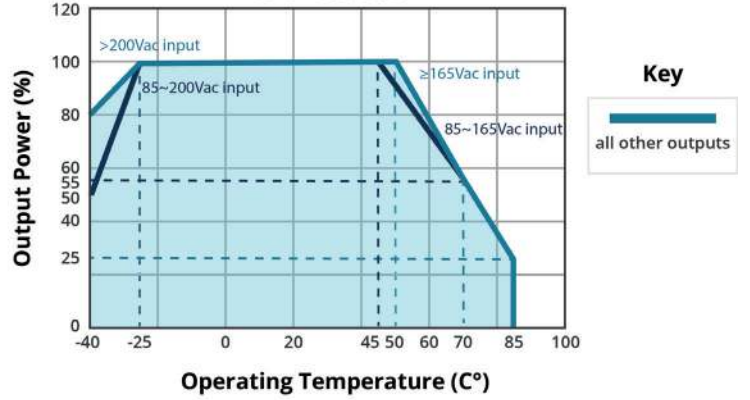

INPUT VOLTAGE DERATING CURVE
(25°C)

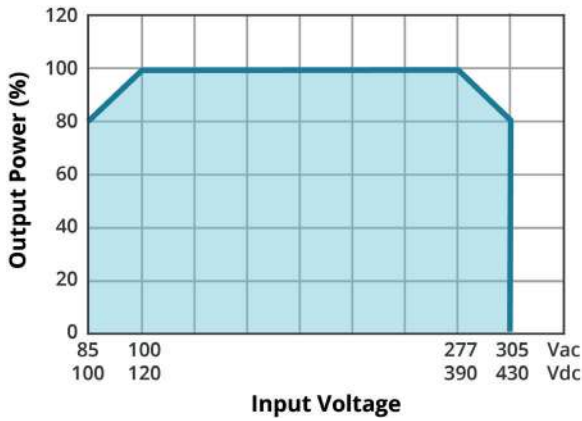

ALTITUDE DERATING CURVE (25°C)

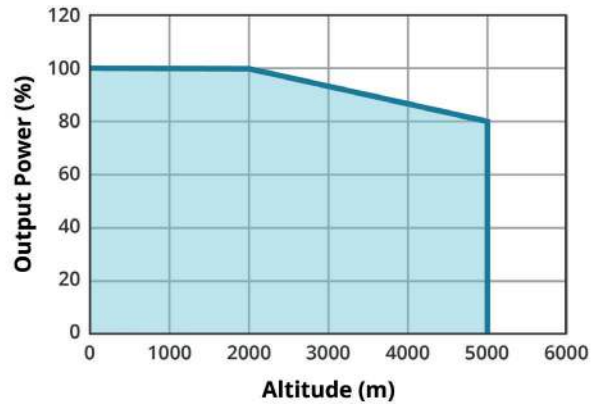

Note: 1. With an AC input between 85~100V/277~305Vac and a DC input between 100~120V/390~430Vdc, the output power must be derated as per temperature derating curves.
2. This product is suitable for applications using natural air cooling; for applications in closed environment please consult with CUI.

EFFICIENCY CURVES

EFFICIENCY VS INPUT VOLTAGE
(full load)

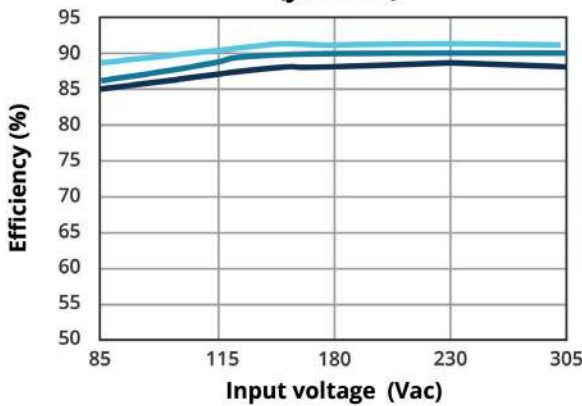

EFFICIENCY VS OUTPUT LOAD
(Vin = 230 Vac)

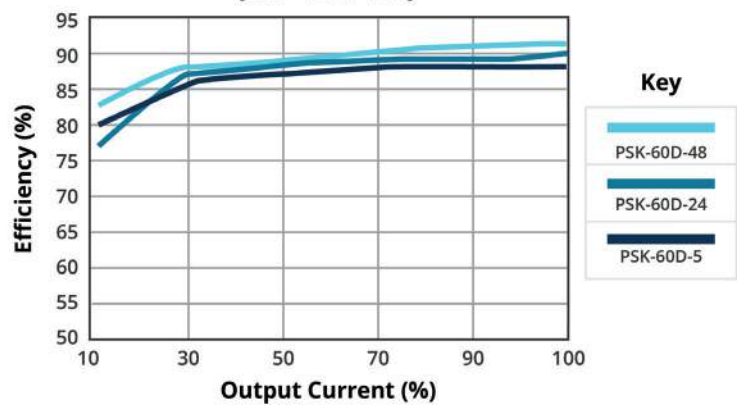

APPLICATION DESIGN REFERENCE

Output Filtering Components:

We recommend using an electrolytic capacitor with high frequency, and low ESR rating for C2 (refer to manufacture’s datasheet). Choose a Capacitor voltage rating with at least 20% margin, in other words not exceeding 80%. C1 is a ceramic capacitor used for filtering high-frequency noise and TVS is a recommended suppressor diode to protect the application in case of a converter failure.

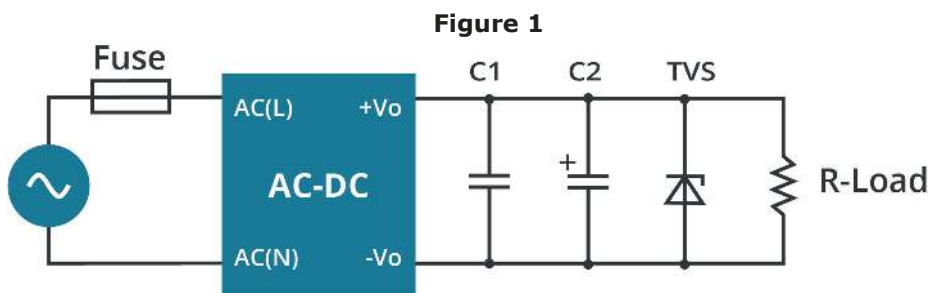
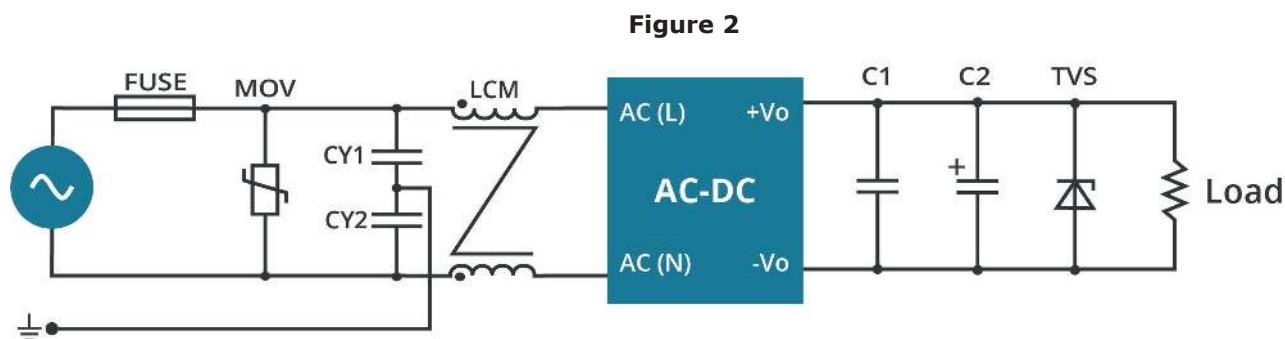

Table 1

Part No.	FUSE	C1	C2	TVS
PSK-60D-5	3.15A/300V slow-blow required	1μF/50V	470μF/16V	SMBJ10A
PSK-60D-12			330μF/25V	SMBJ20A
PSK-60D-15			330μF/25V	SMBJ30A
PSK-60D-24			220μF/35V	SMBJ40A
PSK-60D-48		1μF/100V	100μF/63V	SMBJ60A

EMC RECOMMENDED CIRCUIT



Note: EMC application circuit with higher requirements.

Table 2

Components	Recommended Value
FUSE	3.15A/300V, slow-blow, required
MOV	S14K350
CY1/CY2	1nF/400Vac
LCM	20mH

REVISION HISTORY

rev.	description	date
1.0	initial release	02/06/2023

The revision history provided is for informational purposes only and is believed to be accurate.



Headquarters
20050 SW 112th Ave.
Tualatin, OR 97062
800.275.4899

Fax 503.612.2383
cui.com
techsupport@cui.com

CUI offers a two (2) year limited warranty. Complete warranty information is listed on our website.

CUI reserves the right to make changes to the product at any time without notice. Information provided by CUI is believed to be accurate and reliable. However, no responsibility is assumed by CUI for its use, nor for any infringements of patents or other rights of third parties which may result from its use.

CUI products are not authorized or warranted for use as critical components in equipment that requires an extremely high level of reliability. A critical component is any component of a life support device or system whose failure to perform can be reasonably expected to cause the failure of the life support device or system, or to affect its safety or effectiveness.