

Signal Ferrite Chip Bead High Current type

SIM-32 series

MERITEK

FEATURE

- Operating temperature: -40°C ~ +125°C (Including self-temperature rise)
- Monolithic inorganic material construction.
- Closed magnetic circuit avoids crosstalk.
- Excellent solderability and heat resistance
- High reliability
- Low DC resistance electrode structure



PART NUMBERING SYSTEM



SIM 05 601 Y 2A0 32
(1) (2) (3) (4) (5) (6)

No	item	Code	Description	Series Reference
(1)	Product Code	SIM	Signal Inductor	Multi-Layer Ferrite Chip Bead
(2)	Dimension	05	05: 0805, 2.0x1.25mm	See Dimension Table
(3)	Impedence	601	601: 600Ω	First two: Significant, Third digit: Multiplier
(4)	Tolerance	Y	Y: ±25%	-25% ~ +25%
(5)	Rated Current	2A0	2A0: 2.0A	Max Current, 'A' denotes decimal point
(6)	Series Code	32	Meritek Series Code	32: High Current Type

DIMENSIONS

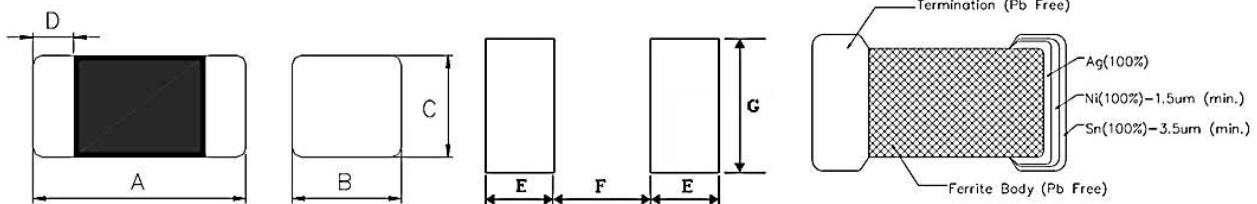

Size	A (mm)	B (mm)	C (mm)	D (mm)	E (mm)	F (mm)	G (mm)
SIM01 (0201)	0.60±0.03	0.30±0.03	0.30±0.03	0.15±0.05	0.35	0.30	0.40
SIM02 (0402)	1.00±0.10	0.50±0.10	0.50±0.10	0.25±0.10	0.50	0.40	0.60
SIM03 (0603)	1.60±0.15	0.80±0.15	0.80±0.15	0.30±0.20	0.80	0.85	0.95
SIM05 (0805)	2.00±0.20	1.25±0.20	0.85±0.20	0.50±0.30	1.05	1.00	1.45
SIM06 (1206)	3.20±0.20	1.60±0.20	1.10±0.20	0.50±0.30	1.05	2.20	1.80
SIM86 (1806)	4.50±0.20	1.60±0.20	1.60±0.20	0.50±0.30	1.05	3.30	1.80
SIM82 (1812)	4.50±0.20	3.20±0.20	1.50±0.20	0.50±0.30	1.05	3.30	3.40

Signal Ferrite Chip Bead High Current type

SIM-32 series

MERITEK

ELECTRICAL CHARACTERISTICS

Size	Part Number	Impedance (Ω)	Tolerance (%)	Test Frequency (MHz)	DCR (Ω) Max.	Rated Current (mA)
0201	SIM01100Y1A332	10	±25	100	0.03	1300
	SIM01220Y1A032	22	±25	100	0.065	1000
	SIM01330Y1A032	33	±25	100	0.07	1000
	SIM01800Y1A032	80	±25	100	0.12	1000
	SIM01121YA8532	120	±25	100	0.15	850
0402	SIM02100Y2A532	10	±25	100	0.05	2500
	SIM02121Y2A032	120	±25	100	0.095	2000
	SIM02221Y1A532	220	±25	100	0.15	1500
	SIM02330Y3A032	33	±25	100	0.022	3000
	SIM02600Y2A532	60	±25	100	0.032	2500
	SIM02800Y2A332	80	±25	100	0.038	2300
0603	SIM03260Y6A032	26	±25	100	0.01	6000
	SIM03300Y3A032	30	±25	100	0.04	3000
	SIM03800Y3A032	80	±25	100	0.04	3000
	SIM03121Y2A032	120	±25	100	0.10	2000
	SIM03151Y2A032	150	±25	100	0.10	2000
	SIM03221Y2A032	220	±25	100	0.10	2000
	SIM03301Y1A032	300	±25	100	0.20	1000
	SIM03471Y1A032	470	±25	100	0.20	1000
	SIM03601Y1A032	600	±25	100	0.20	1000
0805	SIM05300Y3A032	30	±25	100	0.04	3000
	SIM05800Y3A032	80	±25	100	0.04	3000
	SIM05121Y2A032	120	±25	100	0.10	2000
	SIM05151Y2A032	150	±25	100	0.10	2000
	SIM05221Y2A032	220	±25	100	0.10	2000
	SIM05301Y1A032	300	±25	100	0.20	1000
	SIM05471Y1A032	470	±25	100	0.20	1000
	SIM05601Y1A032	600	±25	100	0.20	1000
1206	SIM06300Y3A032	30	±25	100	0.04	3000
	SIM06500Y3A032	50	±25	100	0.04	3000
	SIM06800Y3A032	80	±25	100	0.04	3000
	SIM06121Y2A032	120	±25	100	0.10	2000
	SIM06151Y2A032	150	±25	100	0.10	2000
	SIM06301Y1A032	300	±25	100	0.20	1000
	SIM06471Y1A032	470	±25	100	0.20	1000
	SIM06501Y3A032	500	±25	100	0.04	3000
	SIM06601Y2A032	600	±25	100	0.10	2000
1806	SIM86600Y6A032	60	±25	60mV/100	0.01	6000
	SIM86800Y3A032	80	±25	60mV/100	0.04	3000

Note: SIM03260Y6A032: C:0.60±0.15

Signal Ferrite Chip Bead High Current type

SIM-32 series

MERITEK

ELECTRICAL CHARACTERISTICS

Size	Part Number	Impedance (Ω)	Tolerance (%)	Test Frequency (MHz)	DCR (Ω) Max.	Rated Current (mA)
1812	SIM82800Y6A032	80	± 25	100	0.01	6000
	SIM82121Y5A032	120	± 25	100	0.02	5000
	SIM82131Y3A032	130	± 25	100	0.04	3000
	SIM82151Y5A032	150	± 25	100	0.02	5000
	SIM82681Y4A032	680	± 25	100	0.03	4000
	SIM82132Y3A032	1300	± 25	100	0.06	3000

CHARACTERISTIC CURVES – SIM01 Series, 0201

SIM01100Y1A332

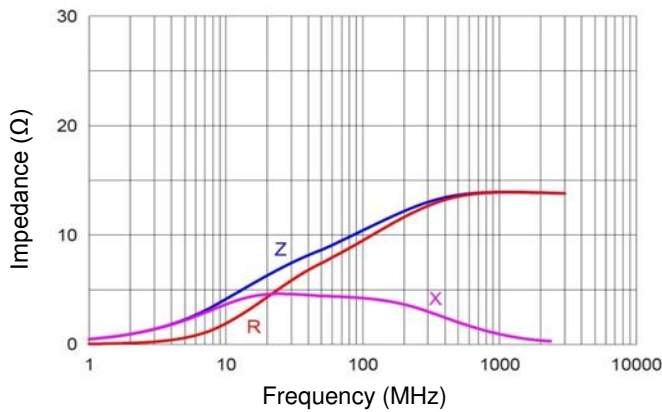

SIM01220Y1A032

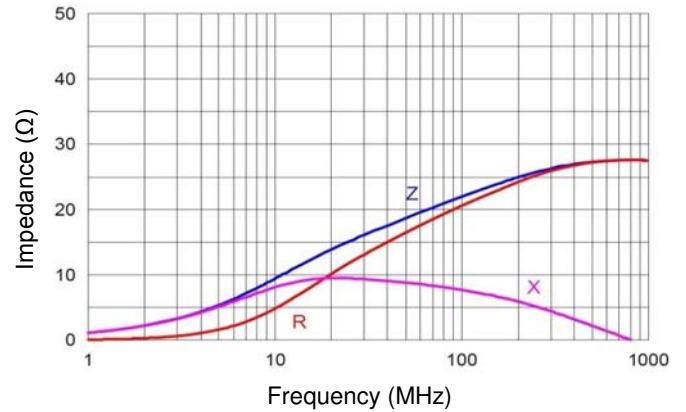

SIM01330Y1A032

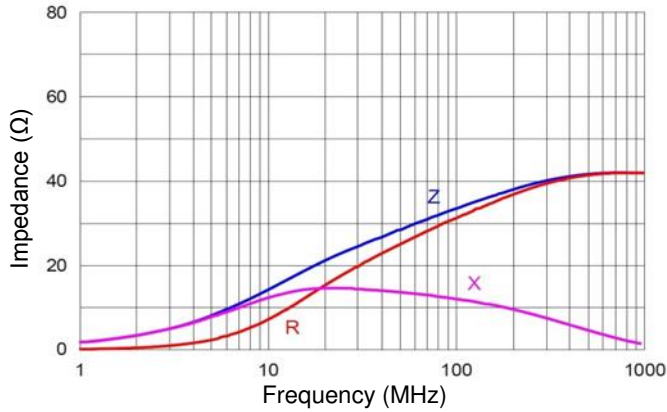

SIM01800Y1A032

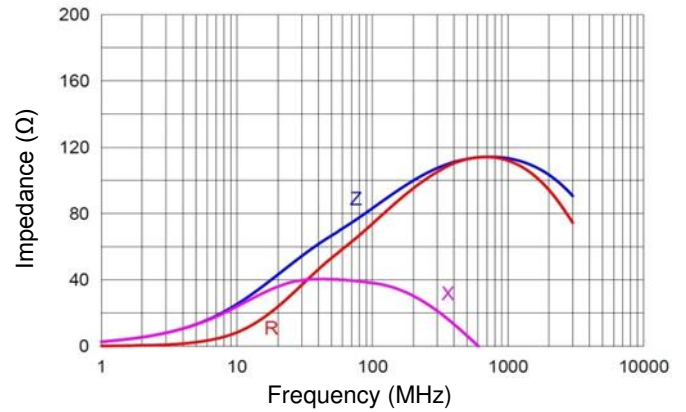

SIM01121YA8532

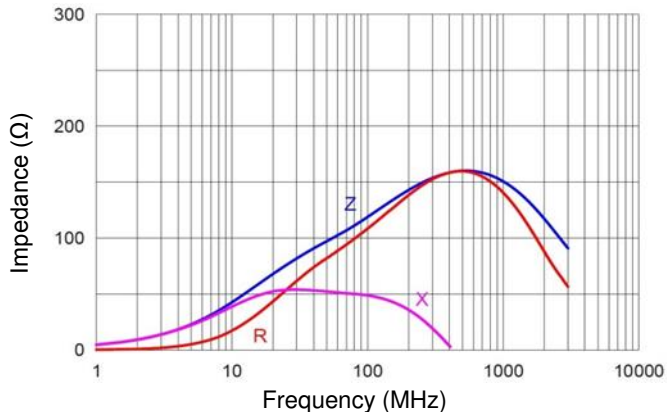

Signal Ferrite Chip Bead High Current type

SIM-32 series

MERITEK

CHARICTERISTIC CURVES – SIM02 Series, 0402

SIM02100Y2A532

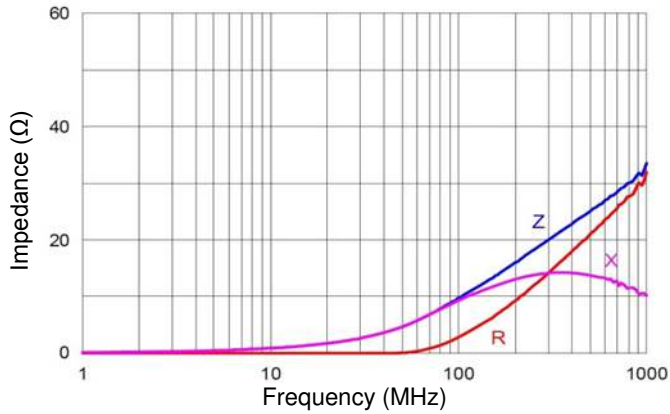

SIM02121Y2A032

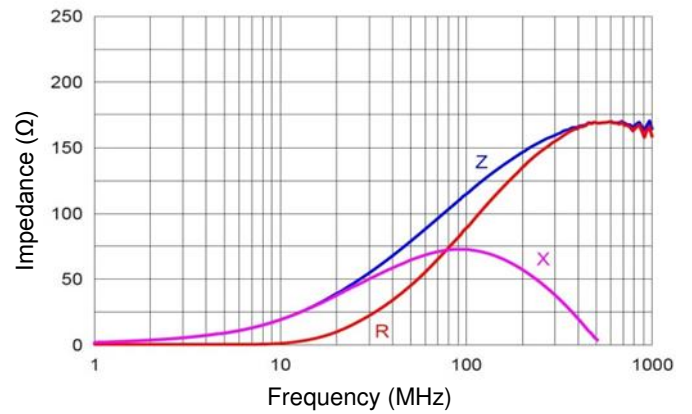

SIM02221Y1A532

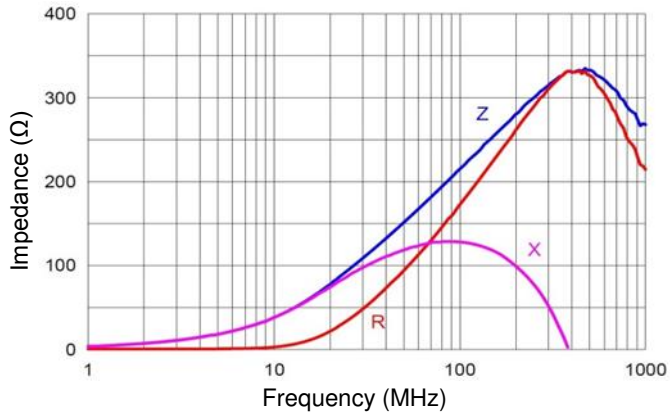

SIM02330Y3A032

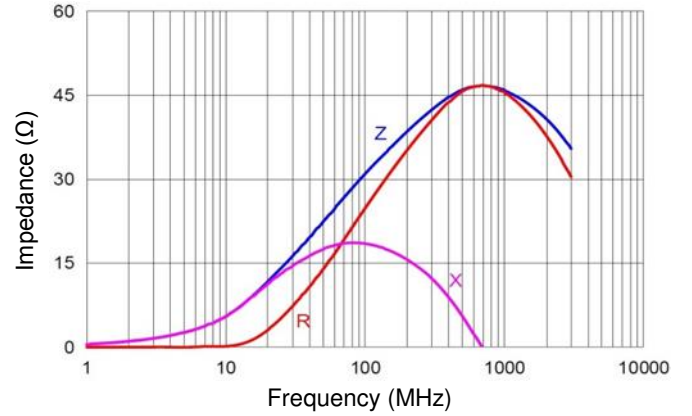

SIM02600Y2A532

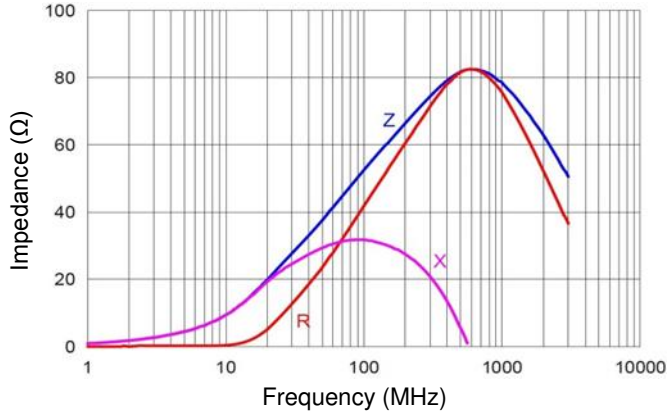

SIM02800Y2A332

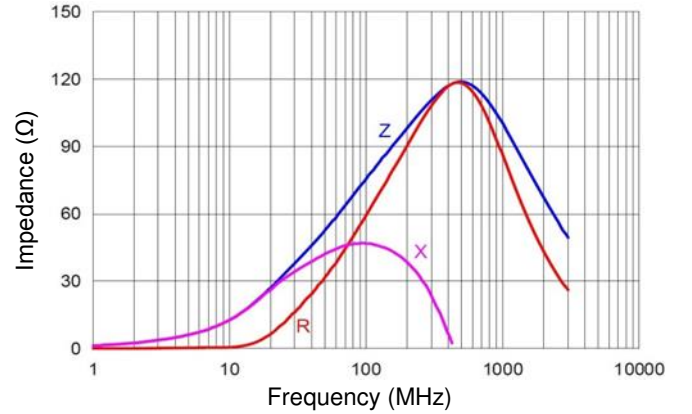

Signal Ferrite Chip Bead High Current type

SIM-32 series

MERITEK

CHARICTERISTIC CURVES – SIM03 Series, 0603

SIM03260Y6A032

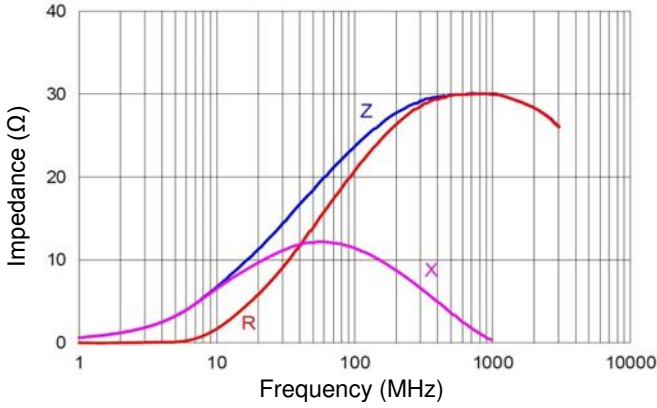

SIM03300Y3A032

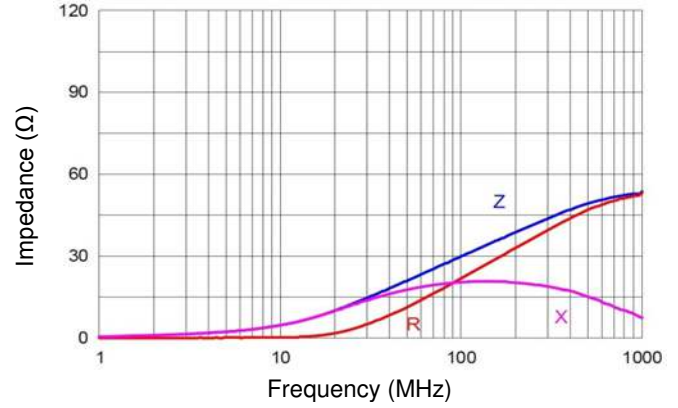

SIM03800Y3A032

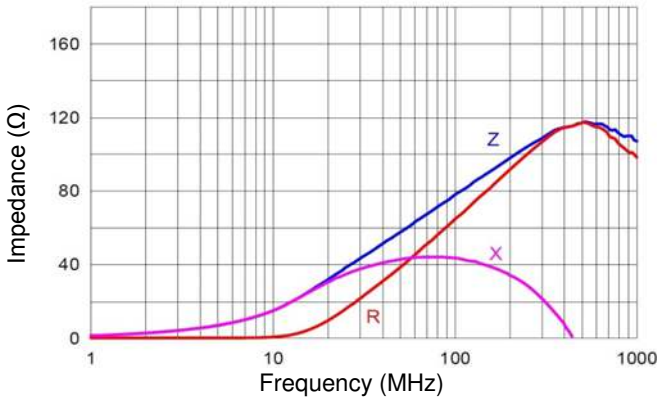

SIM03121Y2A032

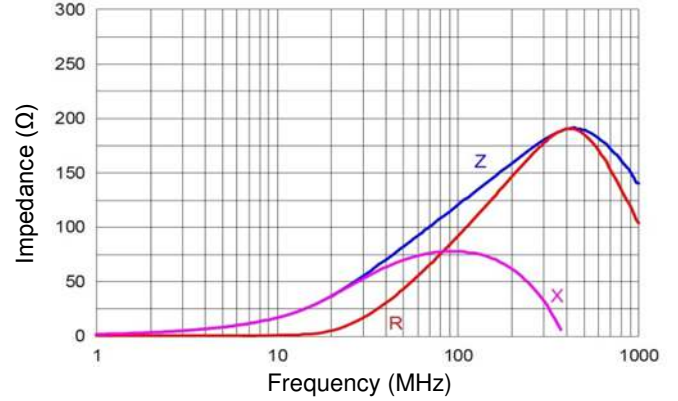

SIM03151Y2A032

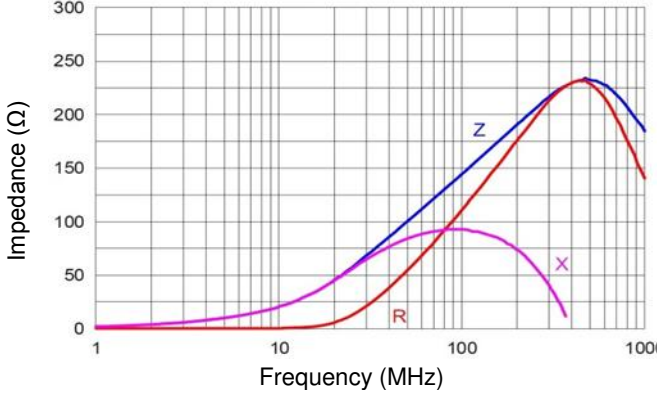

SIM03221Y2A032

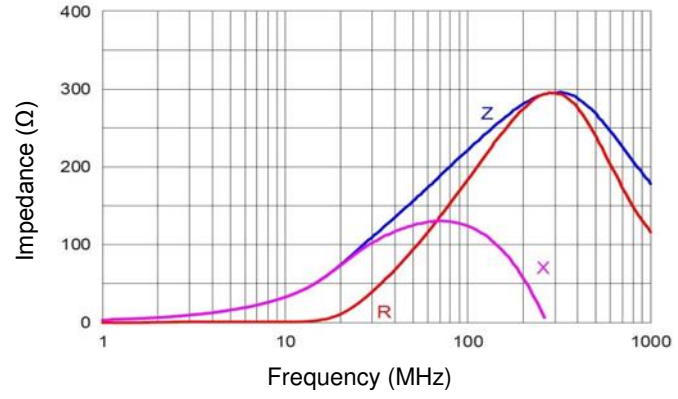

SIM03301Y1A032

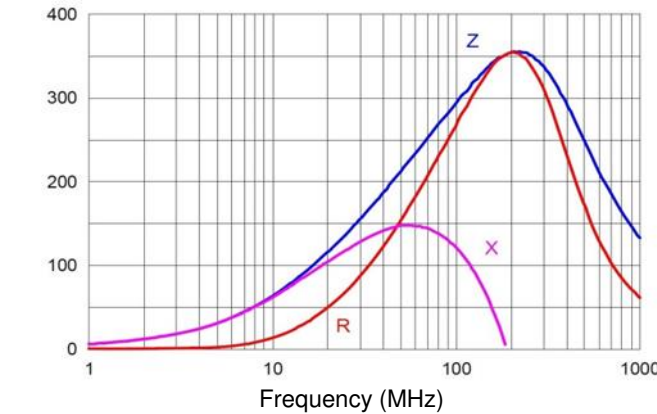

SIM03471Y1A032

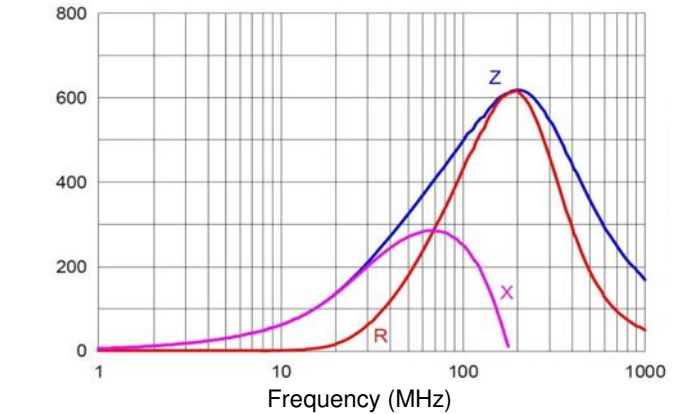

Signal Ferrite Chip Bead High Current type

SIM-32 series

MERITEK

CHARICTERISTIC CURVES-SIM03 Series, 0603

SIM03601Y1A032

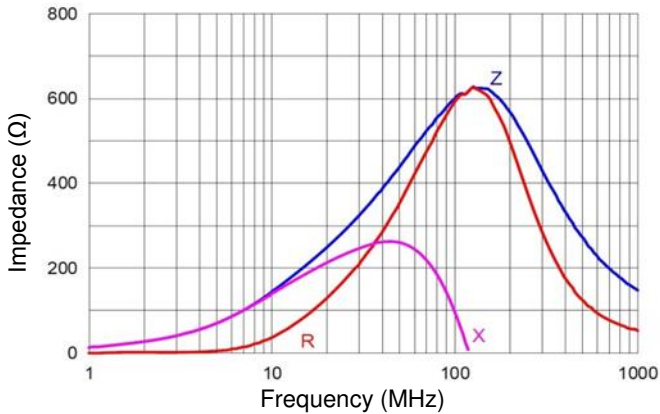

CHARICTERISTIC CURVES – SIM05 Series, 0805

SIM05300Y3A032

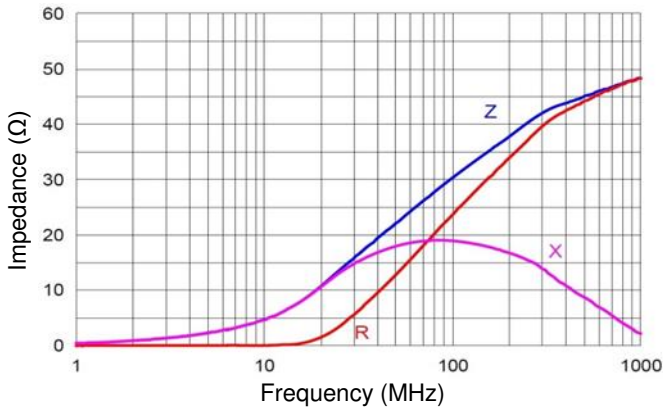

SIM05800Y3A032

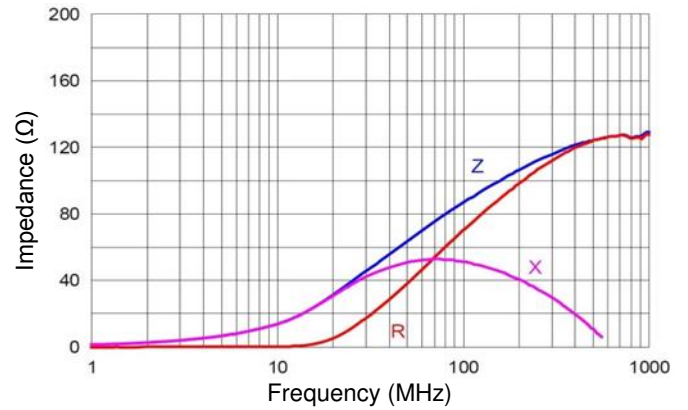

SIM05121Y2A032

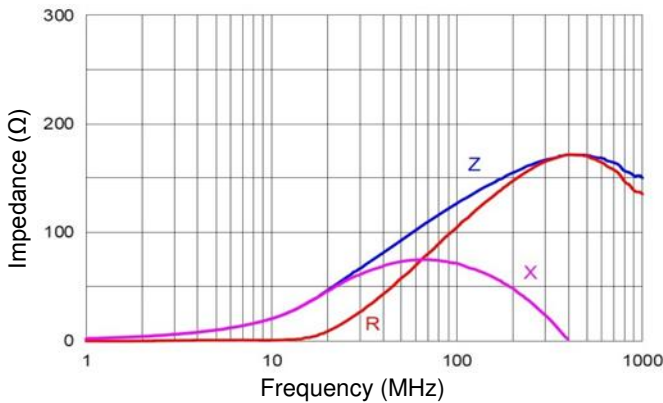

SIM05151Y2A032

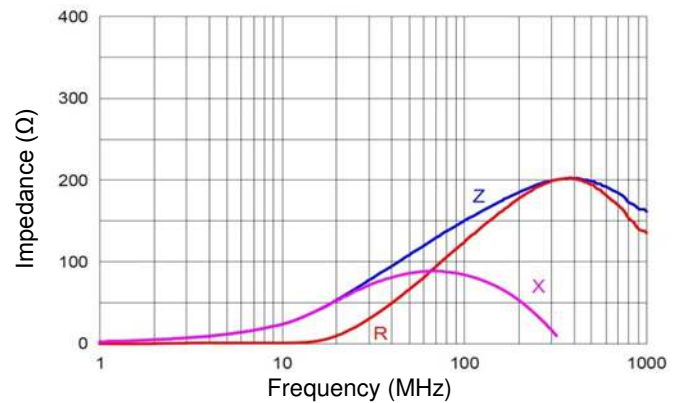

SIM05221Y2A032

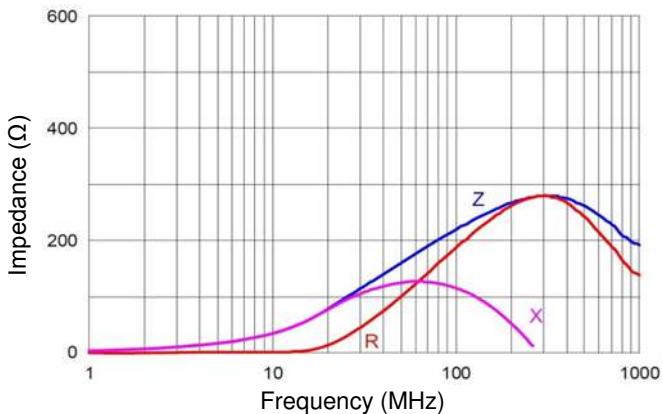

SIM05301Y1A032

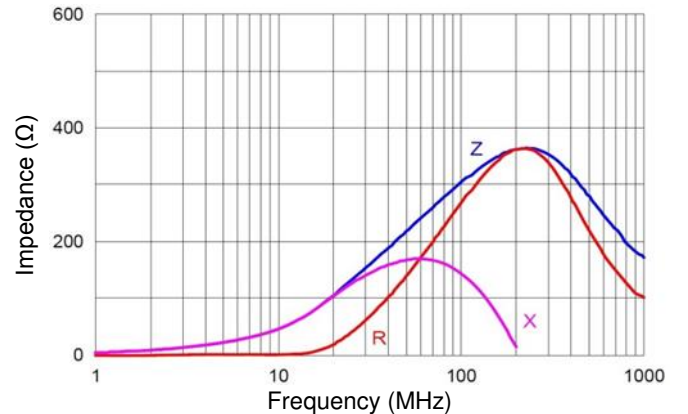

Signal Ferrite Chip Bead High Current type

SIM-32 series

MERITEK

CHARACTERISTIC CURVES – SIM05 Series, 0805

SIM05471Y1A032

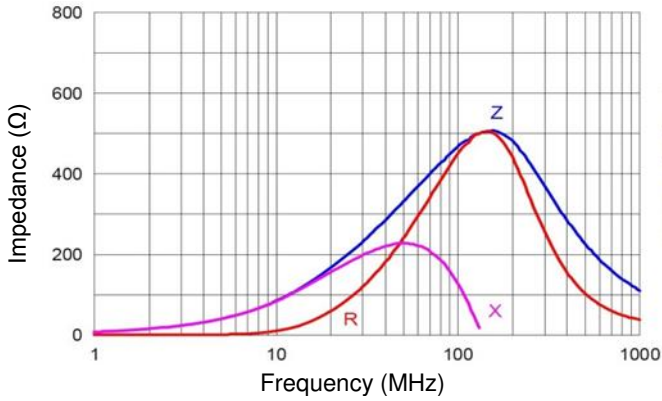

SIM05601Y1A032

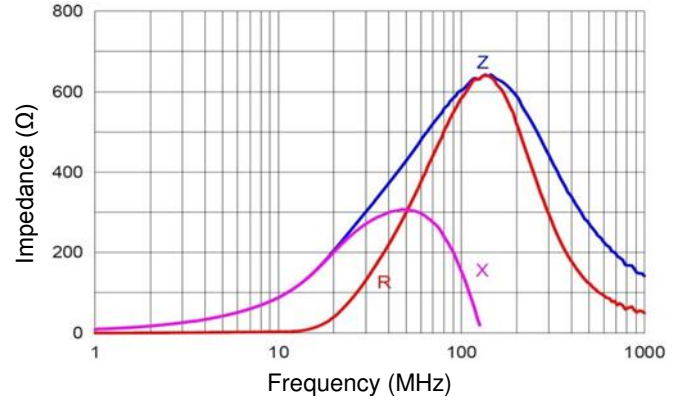

CHARACTERISTIC CURVES – SIM06 Series, 1206

SIM06300Y3A032

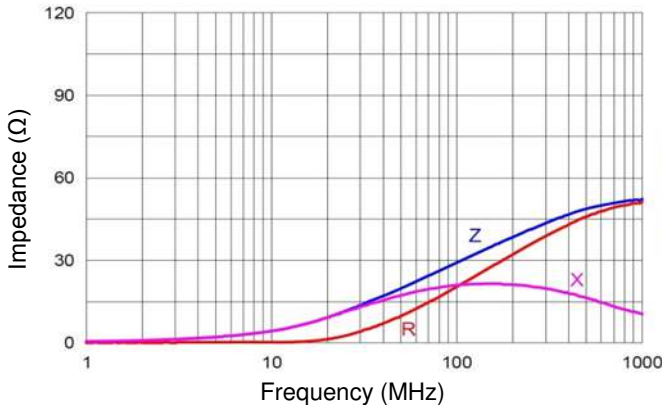

SIM06500Y3A032

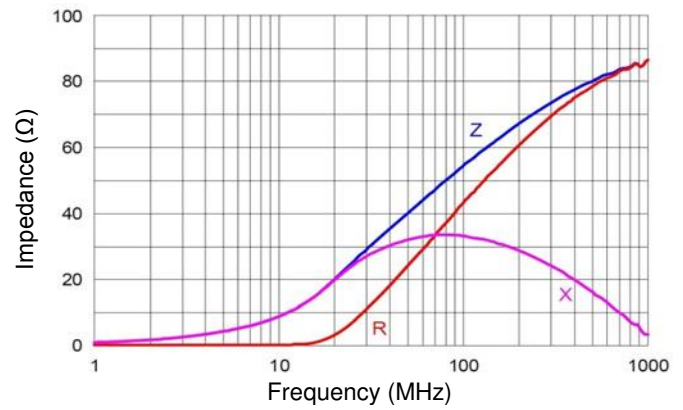

SIM06800Y3A032

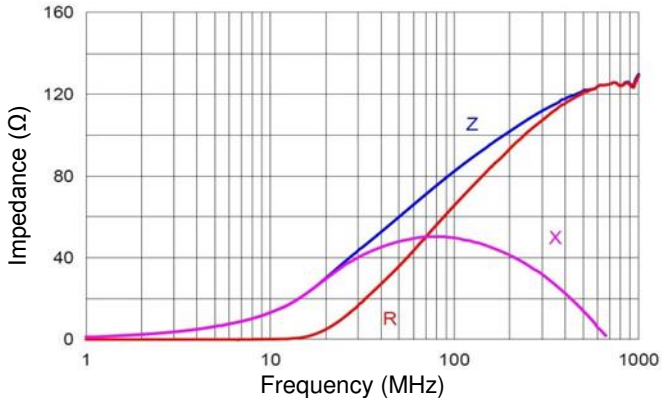

SIM06121Y2A032

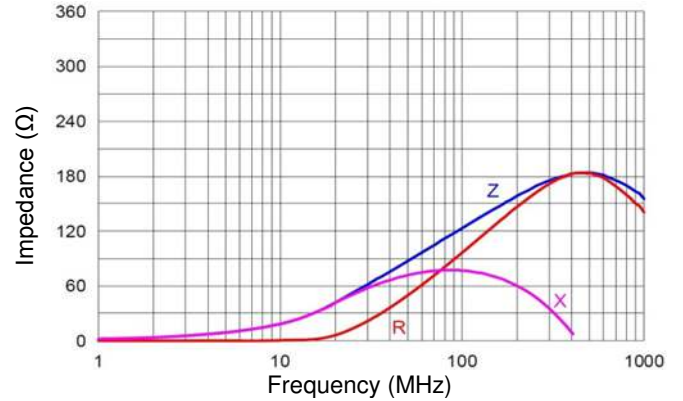

SIM06151Y2A032

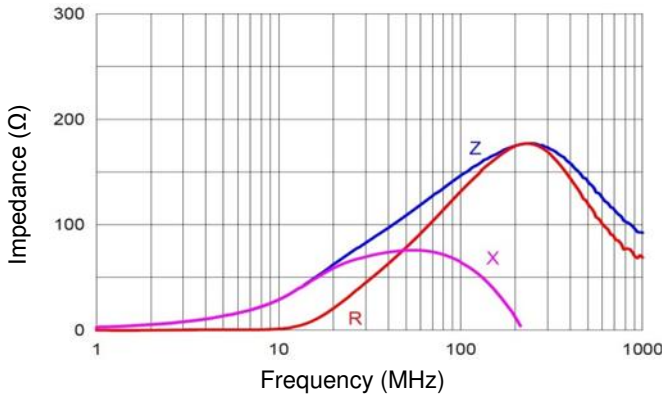

SIM06301Y1A032

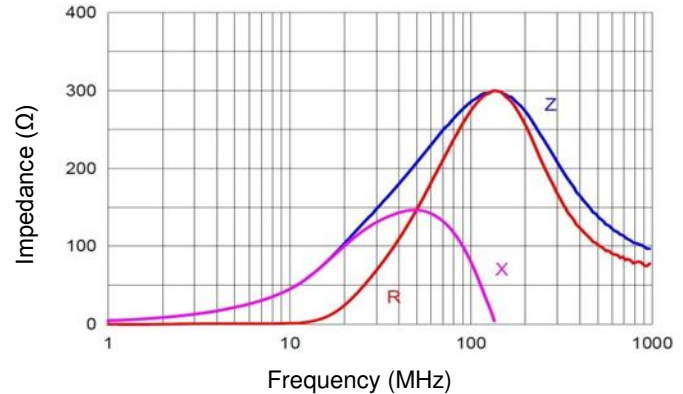

Signal Ferrite Chip Bead High Current type

SIM-32 series

MERITEK

CHARICTERISTIC CURVES-SIM06 Series, 1206

SIM06471Y1A032

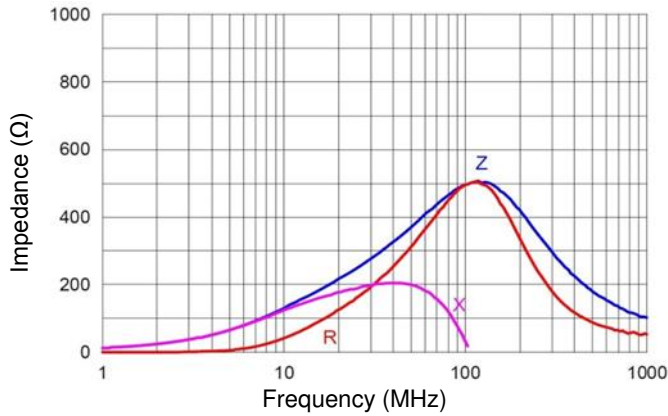

SIM06501Y3A032

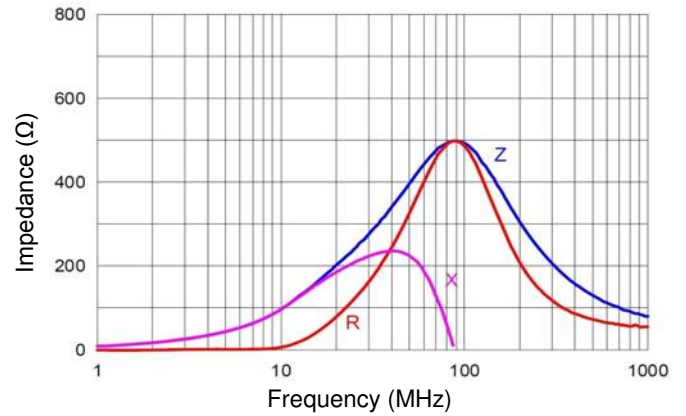

SIM06601Y2A032

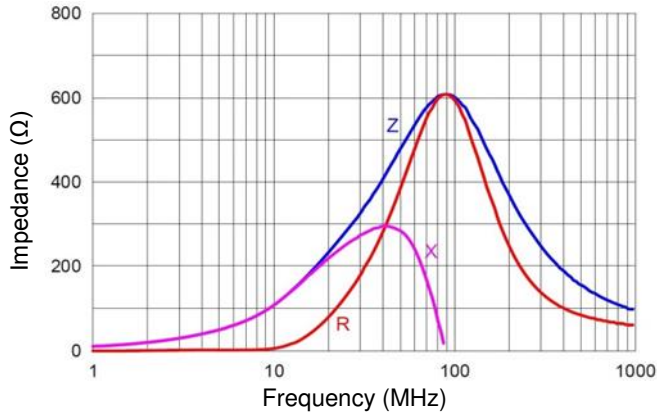

CHARICTERISTIC CURVES – SIM86 Series, 1806

SIM86600Y6A032

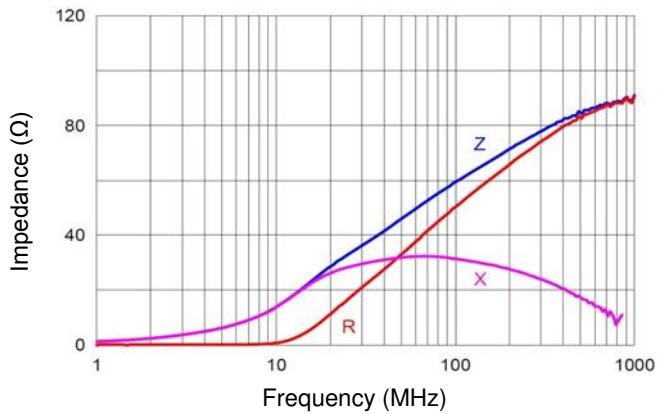

SIM86800Y3A032

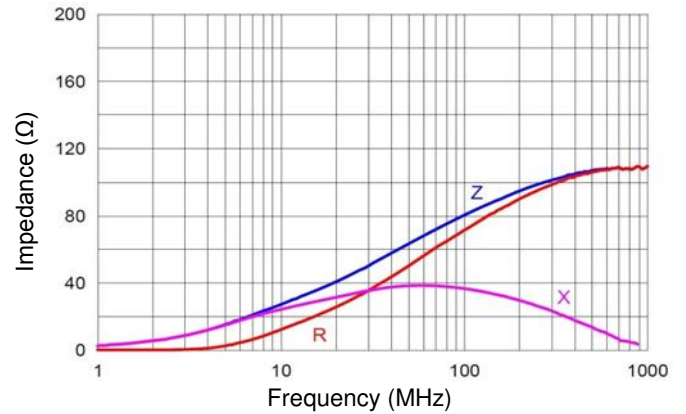

Signal Ferrite Chip Bead High Current type

SIM-32 series

MERITEK

CHARICTERISTIC CURVES – SIM82 Series, 1812

SIM82800Y6A032

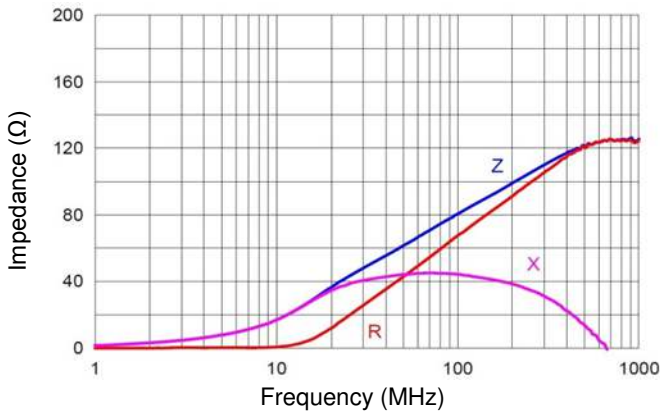

SIM82121Y5A032

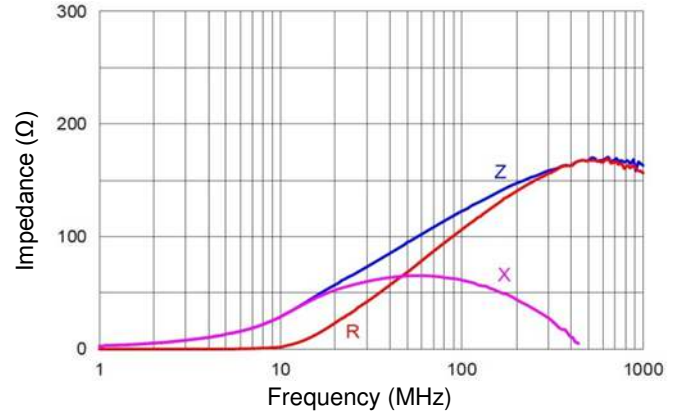

SIM82131Y3A032

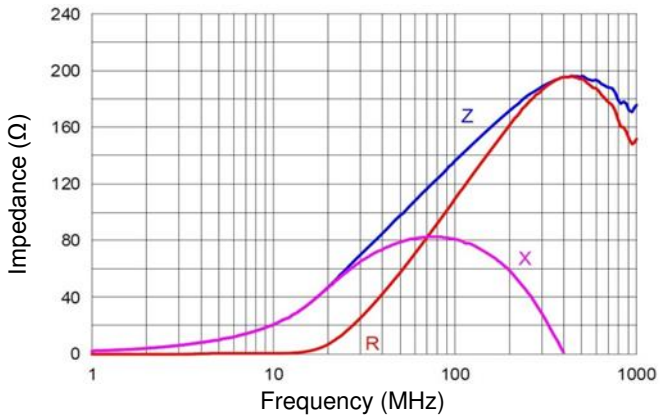

SIM82151Y5A032

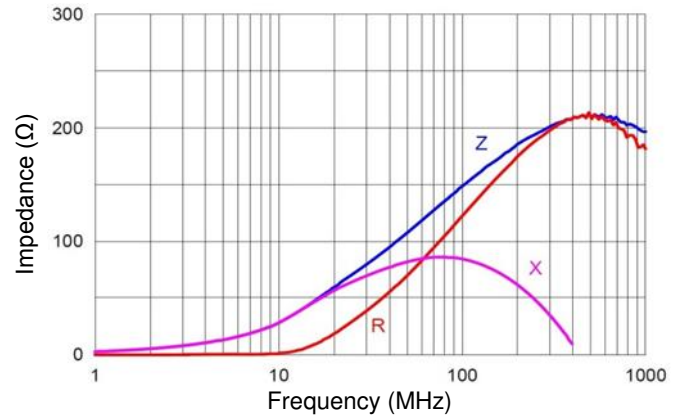

SIM82681Y4A032

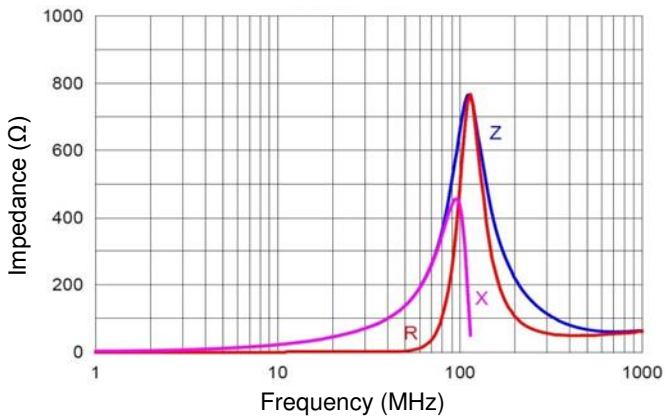

SIM82132Y3A032

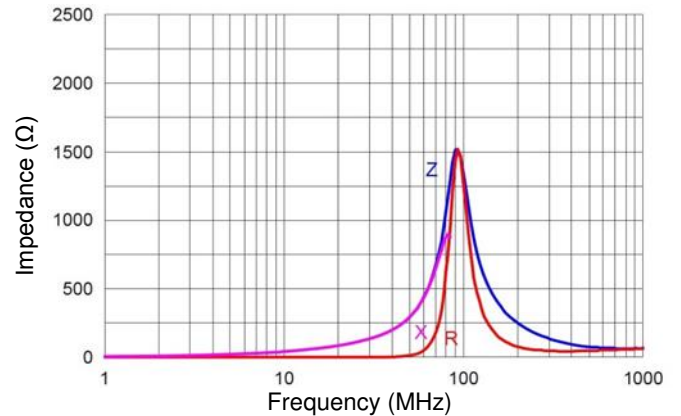

Signal Ferrite Chip Bead High Current type

SIM-32 series

MERITEK

RELIABILITY TEST CONDITON AND REQUIREMENT

Item	Test Standards / Conditions / Equipment	Requirement															
Temperature Rise Test	Applied the allowed DC current. Temperature measured by digital surface thermometer.	Rated Current < 1A Δ T 20°CMax. Rated Current \geq 1A Δ T 40°CMax.															
Solderability	Preheat: 150°C for 60sec., Solder: Sn:96.5% - Ag:3% - Cu:0.5% Solder temperature: 245 \pm 5°C, Flux for lead free: Rosin. 9.5% Depth: completely cover the termination. Dip time: 4 \pm 1sec.	More than 95% of the terminal electrode should be covered with solder.															
Resistance to Soldering Heat	Solder temperature: 260 \pm 5°C for 10 \pm 1 seconds Temperature ramp/immersion and emersion rate 25mm/s \pm 6 mm/s. completely cover the termination.	Appearance: no damage. Impedance: within \pm 15%of initial value. Inductance: within \pm 10%of initial value.															
Vibration	Preconditioning: Run through IR reflow for 2 times. Oscillation Frequency: 10~2K~10 Hz for 20 minutes Equipment : Vibration checker, Total Amplitude:1.52mm \pm 10% Testing Time : 12 hours(20 minutes, 12 cycles each of 3 orientations)	Appearance: no damage. Impedance: within \pm 15%of initial value. Inductance: within \pm 10%of initial value.															
Shock	Test condition: <table border="1"> <thead> <tr> <th>Type</th> <th>Peak Value (g's)</th> <th>Normal duration (ms)</th> <th>Wave From</th> <th>Velocity change (ft/sec)</th> </tr> </thead> <tbody> <tr> <td>SMD</td> <td>50</td> <td>11</td> <td>Half-sine</td> <td>11.3</td> </tr> <tr> <td>Lead</td> <td>50</td> <td>11</td> <td>Half-sine</td> <td>11.3</td> </tr> </tbody> </table>	Type	Peak Value (g's)	Normal duration (ms)	Wave From	Velocity change (ft/sec)	SMD	50	11	Half-sine	11.3	Lead	50	11	Half-sine	11.3	Appearance: no damage. Impedance: within \pm 10%of initial value. Inductance: within \pm 10%of initial value.
Type	Peak Value (g's)	Normal duration (ms)	Wave From	Velocity change (ft/sec)													
SMD	50	11	Half-sine	11.3													
Lead	50	11	Half-sine	11.3													
Terminal strength	Preconditioning: Run through IR reflow for 2 times. With component mounted on a PCB apply a force >0805:1kg , <=0805:0.5kg to the side of a device being tested. This force shall be applied for 60 +1 seconds. Also the force shall be applied gradually as not to shock the component being tested.	Appearance: no damage. Impedance: within \pm 15%of initial value. Inductance: within \pm 10%of initial value.															
Thermal Shock	Preconditioning: Run through IR reflow for 2 times. Number of cycles: 500. Condition for 1 cycle: <table border="1"> <thead> <tr> <th>No.</th> <th>Temp. (°C)</th> <th>Time (min.)</th> </tr> </thead> <tbody> <tr> <td>1</td> <td>-40\pm2°C</td> <td>30\pm5</td> </tr> <tr> <td>2</td> <td>25\pm2°C</td> <td>\leq30 seconds</td> </tr> <tr> <td>3</td> <td>+125\pm2°C</td> <td>30\pm5</td> </tr> </tbody> </table> Measured at room temperature after placing for 24 \pm 2 hrs.	No.	Temp. (°C)	Time (min.)	1	-40 \pm 2°C	30 \pm 5	2	25 \pm 2°C	\leq 30 seconds	3	+125 \pm 2°C	30 \pm 5	Appearance: no damage. Impedance: within \pm 15%of initial value. Inductance: within \pm 10%of initial value.			
No.	Temp. (°C)	Time (min.)															
1	-40 \pm 2°C	30 \pm 5															
2	25 \pm 2°C	\leq 30 seconds															
3	+125 \pm 2°C	30 \pm 5															
Bending	Shall be mounted on a FR4 substrate of the following dimensions: <table border="1"> <thead> <tr> <th>Dimensions</th> <th>Bending depth</th> </tr> </thead> <tbody> <tr> <td>\geq0805:40x100x1.2mm</td> <td>1.2mm</td> </tr> <tr> <td><0805:40x100x0.8mm</td> <td>0.8mm</td> </tr> </tbody> </table> Duration of 10 sec for a min.	Dimensions	Bending depth	\geq 0805:40x100x1.2mm	1.2mm	<0805:40x100x0.8mm	0.8mm	Appearance: no damage. Impedance: within \pm 10%of initial value. Inductance: within \pm 10%of initial value.									
Dimensions	Bending depth																
\geq 0805:40x100x1.2mm	1.2mm																
<0805:40x100x0.8mm	0.8mm																
Load Humidity	Preconditioning: Run through IR reflow for 2 times. Humidity: 85 \pm 2%R.H. Temperature: 85 \pm 2°C. Duration: 1000hrs Min. with 100% rated current. Measured at room temperature after 24 \pm 2 hrs.	Appearance: no damage. Impedance: within \pm 15%of initial value. Inductance: within \pm 10%of initial value.															
Life Test	Preconditioning: Run through IR reflow for 2 times. Temperature: 125 \pm 2°C Applied current: rated current. Duration: 1000 \pm 12 Hrs. Measured at room temperature after 24 \pm 2 Hrs.	Appearance: no damage. Impedance: within \pm 15%of initial value. Inductance: within \pm 10%of initial value.															

Signal Ferrite Chip Bead High Current type

SIM-32 series

MERITEK

RECOMMENDED SOLDERING PROFILES

Reflow Condition		
Pre Heat	Temp. Min $T_{s(min)}$	150°C
	Temp. Max $T_{s(max)}$	200°C
	Time (min. to max.) (t_s)	60 ~180 seconds
Reflow	Temp. (T_L)	217°C
	Time (min. to max.) (t_L)	60 ~150 seconds
Peak Temperature (T_P)		260°C
Time within 5°C of actual peak Temperature (t_p)		10 seconds max.
Reflow times:		3 times Max.

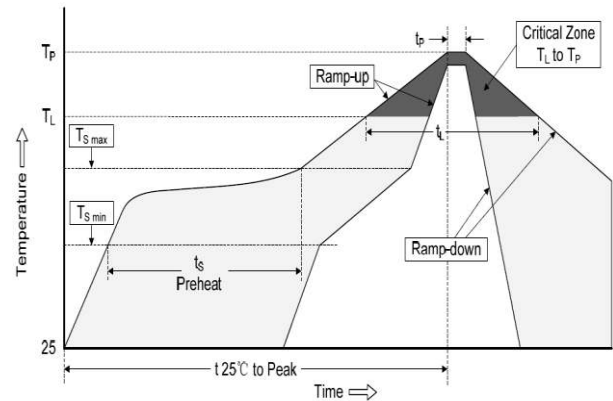

PACKAGING SPECIFICATIONS

Reel Specification & Packaging Quantity

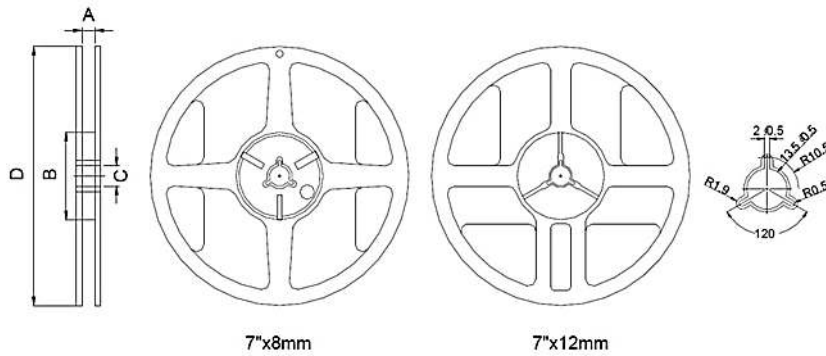

Size	Reel Dimension (mm)						
	Quantity	Tape Width	Reel Diameter	A	B	C	D
0201	Paper 15K	8mm	7"	9.5±0.5	60.0+2.0	13.5±0.5	178.0±2.0
0402	Paper 10K	8mm	7"	9.5±0.5	60.0+2.0	13.5±0.5	178.0±2.0
0603	Paper 4K	8mm	7"	9.5±0.5	60.0+2.0	13.5±0.5	178.0±2.0
0805	Paper 4K	8mm	7"	9.5±0.5	60.0+2.0	13.5±0.5	178.0±2.0
1206	Plastic 3K	8mm	7"	9.5±0.5	60.0+2.0	13.5±0.5	178.0±2.0
1806	Plastic 2K	12mm	7"	13.5±0.5	60.0+2.0	13.5±0.5	178.0±2.0
1812	Plastic 1K	12mm	7"	13.5±0.5	60.0+2.0	13.5±0.5	178.0±2.0

Signal Ferrite Chip Bead High Current type

SIM-32 series

MERITEK

PACKAGING SPECIFICATIONS

Paper Tape Specification

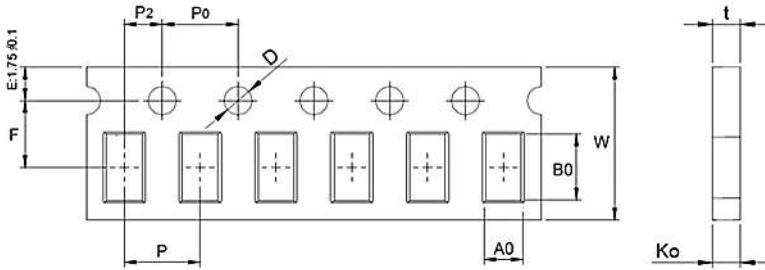

Plastic Tape Specification

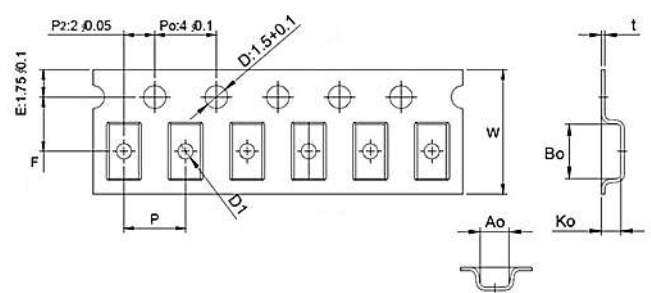

Size	Paper Tape Dimension (mm)									
	A0	B0	W	F	P ₀	P	P ₂	D	t	Ko
0201	0.4±0.06	0.7±0.06	8±0.3	3.5±0.05	4±0.1	2±0.05	-	1.5±0.1	0.45max	0.45max
0402	0.62±0.03	1.12±0.03	8±0.3	3.5±0.05	4±0.1	2±0.05	-	1.5±0.1	0.6±0.03	0.6±0.03
0603	0.96±0.05/ -0.03	1.80±0.05	8±0.1	3.5±0.1	4±0.1	4±0.1	2±0.1	1.56±0.1/ -0.05	0.95±0.05	0.95±0.05
0603*	0.97±0.03	1.78±0.03	8±0.1	3.5±0.1	4±0.1	4±0.1	2±0.1	1.56±0.1/ -0.05	0.75±0.03	0.75±0.03
0805	1.3±0.05	2.1±0.05	8±0.1	3.5±0.1	4±0.1	4±0.1	2±0.1	1.56±0.1/ -0.05	0.95±0.05	0.95±0.05
Size	Plastic Tape Dimension (mm)									
	A0	B0	W	F	P	P ₀	P ₂	D1	t	Ko
1206	1.75±0.1	3.35±0.1	8±0.1	3.5±0.05	4±0.1	4±0.1	2±0.05	1±0.1	0.23±0.05	1.25±0.1
1806	1.75±0.1	4.7±0.1	12±0.1	5.5±0.05	4±0.1	4±0.1	2±0.05	1.5±0.1	0.24±0.05	1.75±0.1
1812	3.45±0.1	4.7±0.1	12±0.1	5.5±0.05	8±0.1	4±0.1	2±0.05	1.5±0.1	0.24±0.05	1.60±0.1

Notes: *0603 impedance value 26Ω, thickness is 0.60mm

*Specifications subject to change without notice.