

M8/M12

Circular Connectors

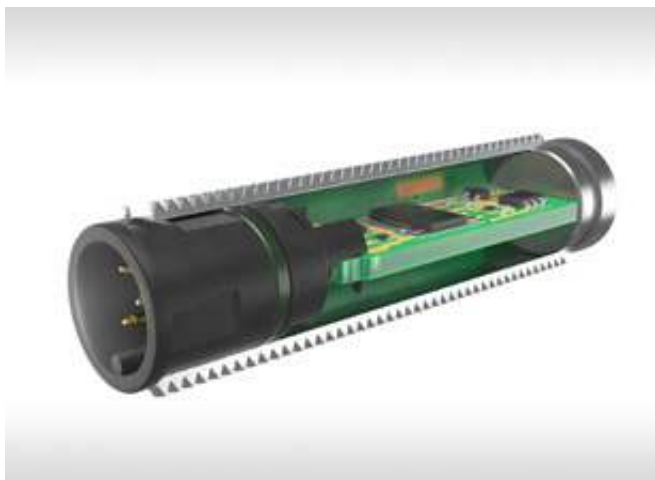

M8/M12 - I/O CONNECTORS

Since the 1980s, M8/M12 connectors have been used in sensor technology and industrial automation devices. The connectors were developed for higher protection classes such as IP65 or IP67. The mating face is coded and standardized so that end customers can use cables from different manufacturers.

Due to the high reliability and robustness, more and more applications and connector codings have been added over the years. The high degree of protection allows decentralized use of the devices and trends such as Industry 4.0 or IIoT are making these devices increasingly intelligent.

The communication of the devices is mostly done via serial systems such as fieldbuses or industrial ethernet. Parallel wiring is largely avoided.

Sensors or actors are mostly connected with an A-coded connector. Fieldbuses, for example, use the B coding.

The installation guidelines of the various bus interest groups also provide for the distribution of the connectors. The guidelines recommend certain connectors for the design, e.g. D and X coding for various ethernet protocols or A coding for sensor bus applications.

In order to ensure efficient processing of these connectors, ERNI developed a solution early on that is packaged in tape and reel and can be assembled automatically; among the world's first M12 connector with Surface-Mount Technology (SMT) connections.



FEATURES

Coding	A, B, D, X
No. of Pins	4 - 17 pin
Termination technology	SMT (Surface Mount Technology), THR (Through Hole Reflow)
Applications	Signal- and data transmission, power supply
Connectors	Male and female connectors 180° Male connectors for direct integration
Extensions	Cable assemblies, quick termination T-Coupler, adapter Panel feed-through
Standards	IEC 61076-2-101 form factor M12, various codings for M12 IEC 61076-2-109 form factor M12, X-coded IEC 61076-2-104 form factor M8, various codings for M8 Profinet- and Profibus-installation instructions Other fieldbus- and Industry ethernet-standards

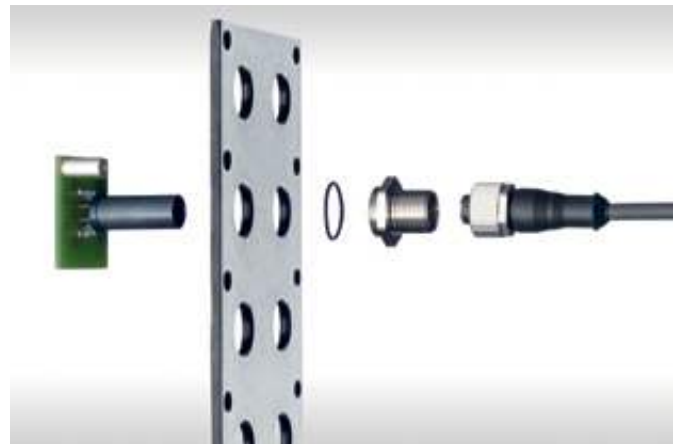

CAPABILITIES

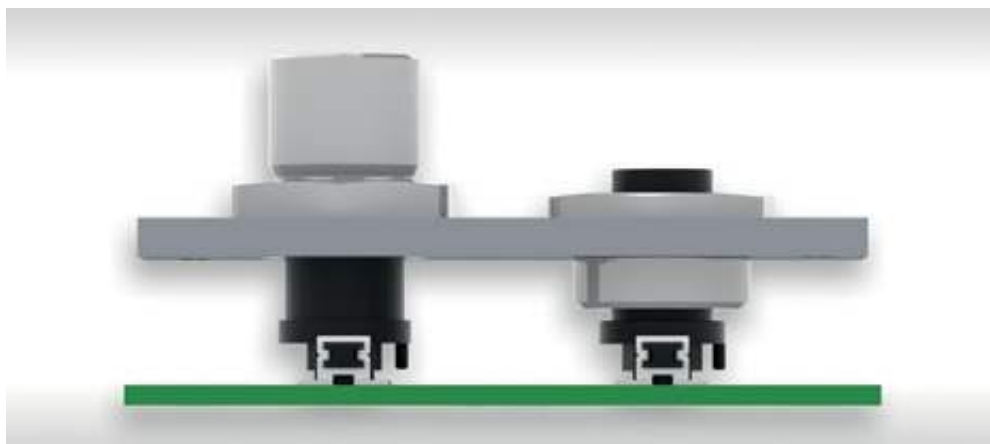

9 and 13 mm heights M12

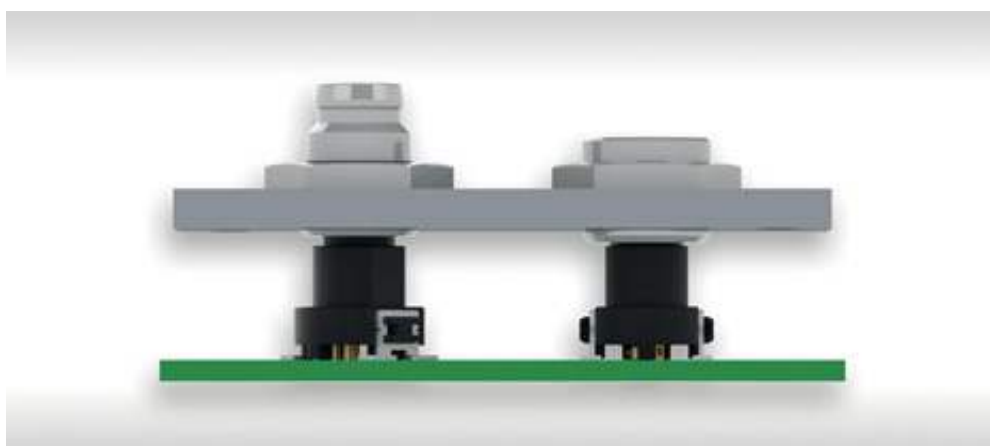

9 and 13 mm heights M8

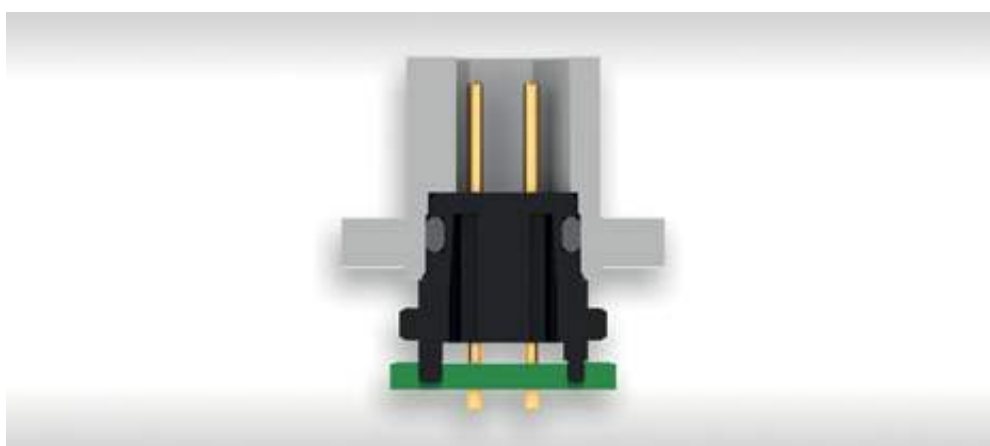

DI applications

CAPABILITIES

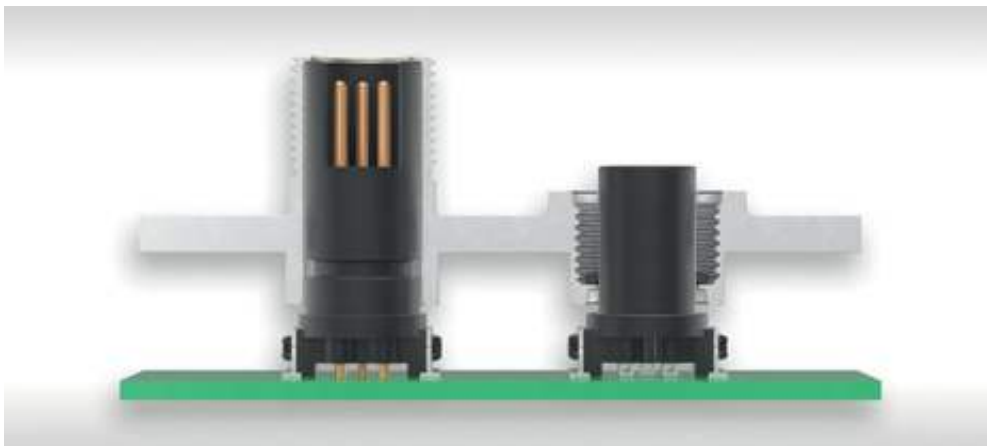

Standard variants
integrated in customer
housing 13 mm die-cast

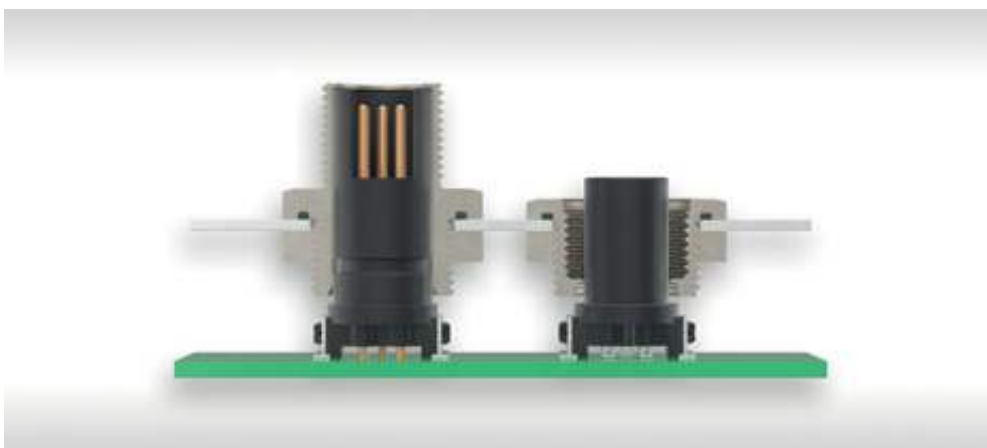

Installation of the
connectors with metal
shells in a thin front panel



Cable outlet 90° and 180°

ADVANTAGES

Stamped Female Contacts

- economical stamped female contact
- reliable due to double-sided contacting
- rolled, homogeneous surface, guarantees more secure contact mating
- gold plated mating area
- extremely low surface roughness significantly reduces abrasion
- low contact resistance
- SMT termination

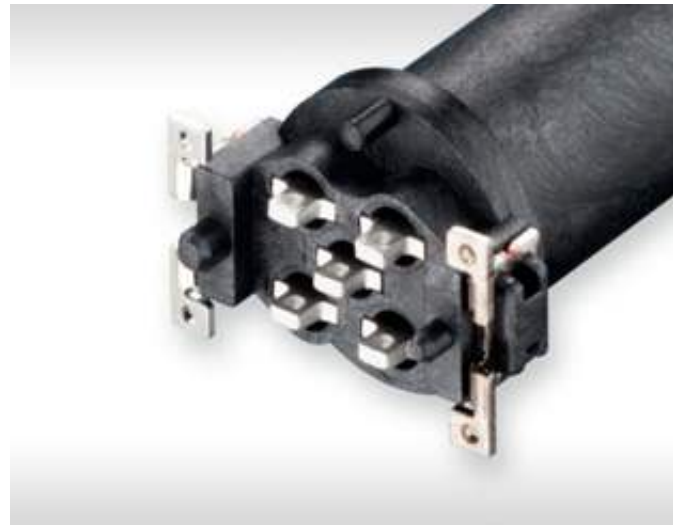

Machined Female Contacts

- reliable due to double-sided contacting
- gold plated mating area
- SMT- or THR-Termination depending on requirements for even more flexibility
- optimized THR solder joints due to short soldering length



Robust Solder Clips

- outstanding retention forces on the circuit board
- soldering brackets absorb mechanical stress and are able to withstand high shock and vibration loads
- high shear and tear-off forces build trust in surface-mounted connectors

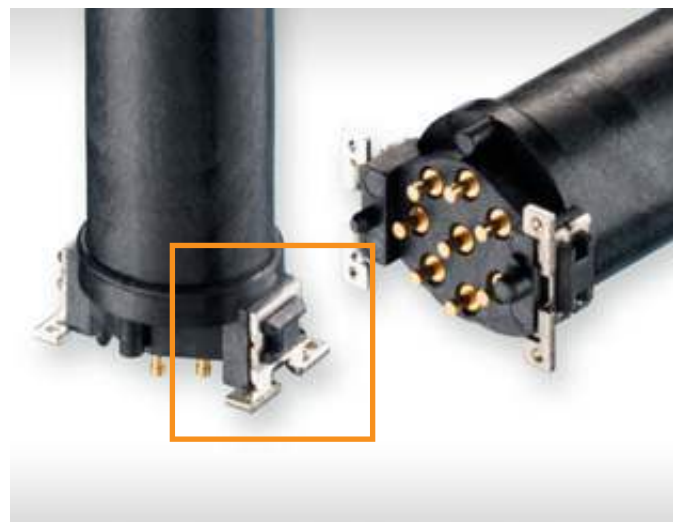

ADVANTAGES

Optional Pad

- with pad for easy assembly with standard nozzles
- without pad cost-optimized for the assembly experts



Potting / Additional Sealing Function

- additional sealing point for male connectors
- protection against liquids even when not plugged in
- prevents leakage of potting material when the electronics must be encapsulated

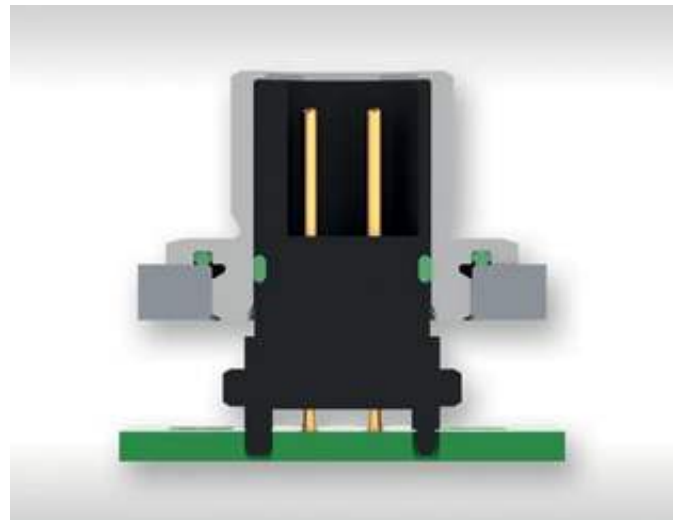

Codings

- coding of the mating face prevents mismating
- different codings enable different interface functions
- pre-alignment of the cable connectors prevents contact damage



PROCESSING

Tape and Reel Packaging

- transport safe packaging
- fully automatic assembly



Fully Automatic Assembly and Reflow Soldering

- for efficient processing on modern assembly lines



INSTALLATION CONDITIONS

Mounting of the Soldering Board

- Printed circuit board fixed in the customer housing by screws or equivalent fastening elements
- O-ring for sealing the connector after assembly pushed over each female connector

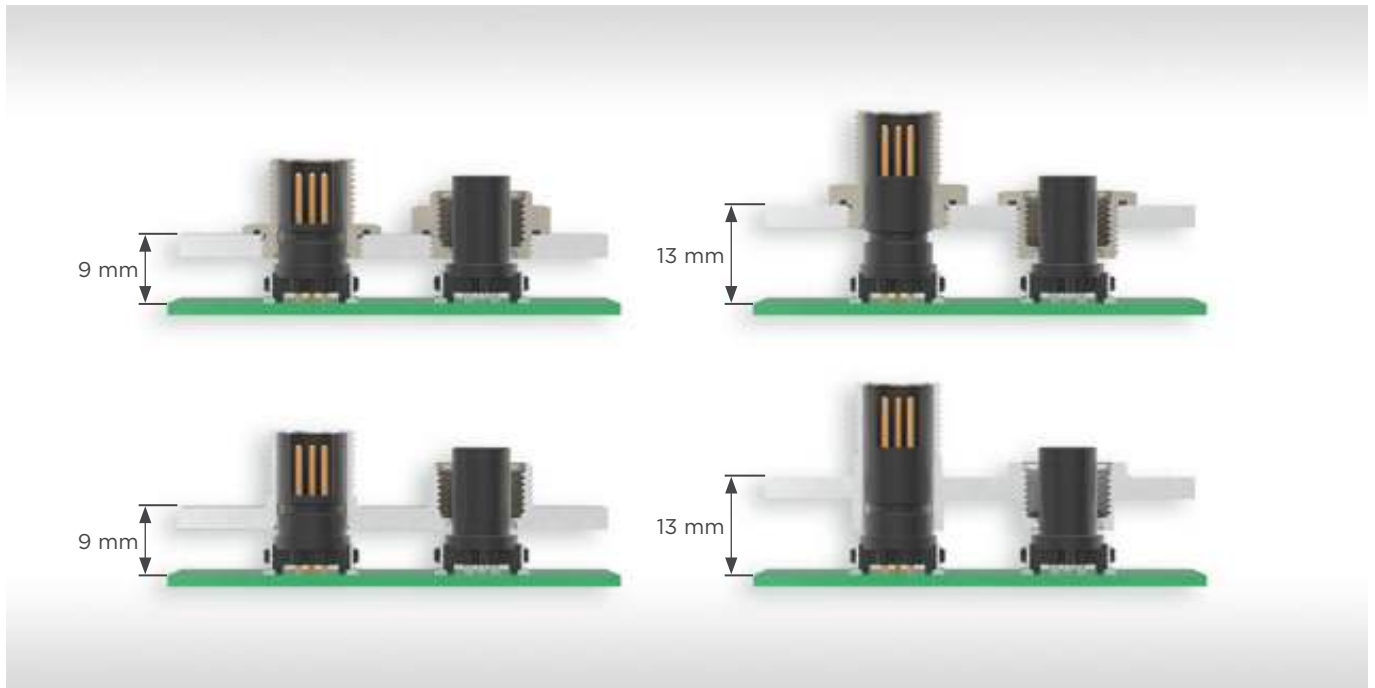

Mounting of the Shielded Version

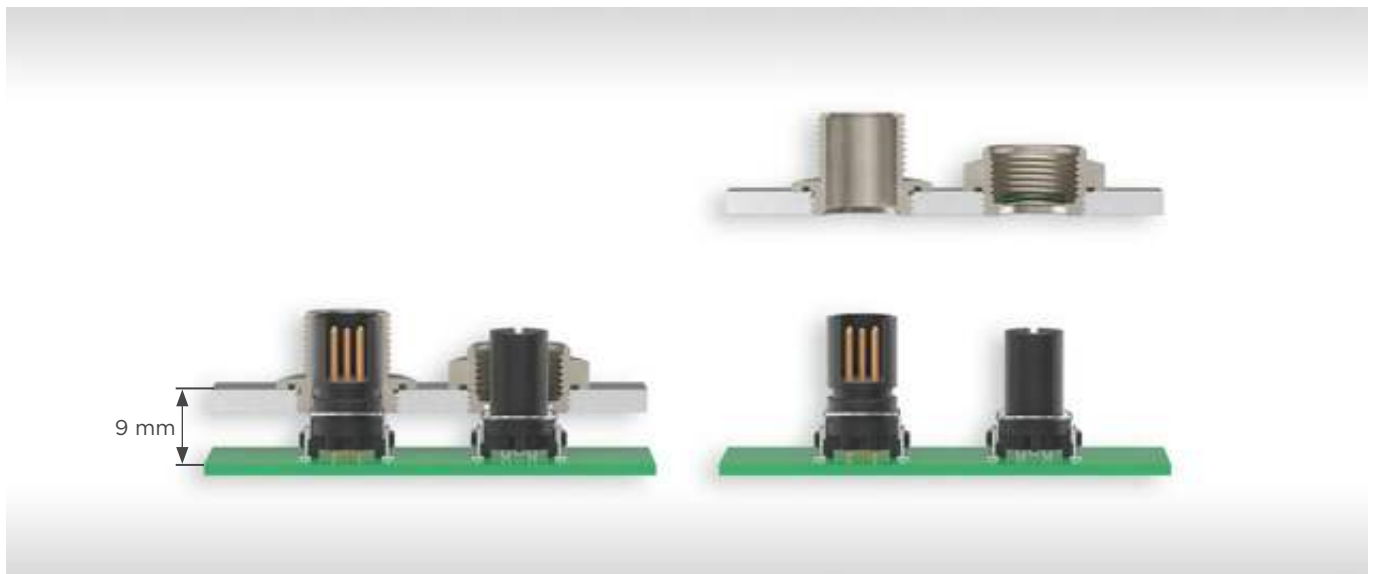

ELECTRICAL AND MECHANICAL CHARACTERISTICS PRINTED CIRCUIT BOARD (PCB) CONNECTORS

Technical Data

Description	Standard	M8	M12
Temperature range		-25 / 85°C (derating curves available up to 125 °C)	
Current rating per contact	IEC60512 test 5b	3 A @ 40 °C (4 pin) see respective derating curve	4 A @ 40 °C (5 pin) see respective derating curve
Min. Air- and creepage distance		0.8 mm	1.1 mm (4-, 5 pin male) 1.0 mm (8 pin male) 0.4 mm (8 pin female)
Operating voltage	IEC 60664-1	The permissible operating voltages depend on the customer application and on the applicable or specified safety requirements. Insulation coordination according to IEC 60664-1 has to be re-garded for the complete electrical device. Therefore, the maximum creepage and clearance distances of the mated connectors are specified for consideration as a part of the whole current path. In practice, reductions in creepage or clearance distances may occur due to the conductive pattern of the printed board or the wiring used, and have to be taken into account separately. As a result the creepage and clearance distances for the application may be reduced compared to those of the connector.	
Dielectric strength (contact-contact)	IEC 60512 test 4a	3 pin: 1000 V _{rms} 4-, 6 pin: 650 V _{rms}	4 pin: 1400 V _{rms} 5 pin: 1000 V _{rms} 8 pin: 650 V _{rms} 8 pin (X): 500 V _{rms} 12-, 17 pin: 500 V _{rms}
Contact resistance	IEC 60512 test 2a	< 10 mΩ	
Insulation resistance	IEC 60512 test 3a	> 10 ⁹ Ω	
Vibration, sine	IEC 60512 test 6d	10 – 500 Hz 5 g	
Contact disturbance (while vibration test)	IEC 60512 test 2e	< 1 μs	
Shock halfsine	IEC 60512 test 6c	50 g 11 ms	
Contact disturbance (while shock test)	IEC 60512 test 2e	< 1 μs	
Mechanical operation	IEC 60512 test 9a	> 100 mating cycles	
Insertion and withdrawal force max.	IEC 60512 test 13b	23 N (3-8 pin)	30 N (17-, 8(X) pin)

ELECTRICAL AND MECHANICAL CHARACTERISTICS PCB CONNECTORS

Technical Data

Description	Standard	M8	M12
Processing Conditions			
Hand soldering temperature max.	IEC 60068-2-20		3.5 s at 350 °C
Dip soldering temperature max.	IEC 60068-2-20		10 s at 260 °C
Reflow soldering temperature max.	JEDEC J-STD-020		20 - 40 s at 260 °C
Coplanarity			< 0.1 mm
Housing Material			
Insulation body			LCP / PA
CTI value	IEC 112		min. 175
UL flame rating			UL 94 V-0
UL file plastic material			E83005 / E47960
Contact Material			
Base material			Cu alloy
Mating area			gold plated
Termination area			Sn (stamped contact) Au (machined contact)
Environment Compatibility			
Recycling			no flame-retardent additives, no toxic additives allow easy recycling
Product Approval			
Protection degree			IP 65/67 (mated)
UL/CSA			E84703

M8 - FEMALE

Product Specification



Ordering Information

No. of Pins	Assembly Height	Coding	Configuration	Termination	Packaging	Part Number
3	9/13 mm	A	M8, female, stamped contacts	SMT	Tape and reel	224150-E
3	9/13 mm	A	M8, female, stamped contacts	SMT	Tape and reel with pad	484599-E
3	9/13 mm	A	M8, female, machined contacts	SMT	Tape and reel	464431-E
3	9/13 mm	A	M8, female, stamped contacts	SMT	Tape and reel	464643-E
3	9/13 mm	A	M8, female, stamped contacts	SMT	Bulk	234233-E
4	9/13 mm	A	M8, female, stamped contacts	SMT	Tape and reel	224151-E
4	9/13 mm	A	M8, female, stamped contacts	SMT	Tape and reel with pad	494375-E
4	9/13 mm	A	M8, female, machined contacts	SMT	Tape and reel	464432-E
4	9/13 mm	A	M8, female, stamped contacts	SMT	Bulk	234234-E
4	9/13 mm	A	M8, female, machined contacts	THR	Bulk	474231-E
6	9/13 mm	A	M8, female, machined contacts	SMT	Tape and reel	464561-E
6	9/13 mm	A	M8, female, machined contacts	SMT	Tape and reel with pad	515814-E

M8 - MALE

Product Specification



Ordering Information

No. of Pins	Assembly		Configuration	Termination	Packaging	Part Number
	Height	Coding				
4	9/13 mm	A	M8, male, machined contacts	SMT	Tape and reel with cap	224152-E
4	9/13 mm	A	M8, male, machined contacts	SMT	Bulk	234235-E
4	9/13 mm	A	M8, male	THR	Tape and reel	225499-E

M8 - ACCESSORIES

Product Specification



Ordering Information

Configuration	Material	Color	Assembly Height	Packaging	Part Number
Metal shell, for M8 female connectors	CuZn nickel plated	-	9 mm	Bulk	254154-E
Metal shell, for M8 female connectors	CuZn nickel plated	-	13 mm	Bulk	284067-E
Metal shell, for M8 male connectors	CuZn nickel plated	-	9 mm	Bulk	284409-E
Metal shell, for M8 male connectors	CuZn nickel plated	-	13 mm	Bulk	284074-E
Counternut, M10x1 SW14	Steel, tin plated	-	-	Bulk	394905-E
O-Ring, for M8 female connectors, 5x0.8	FKM	green	-	Bulk	494564-E
O-Ring, for M8 female connectors, 5x0.8	FKM	black	-	Bulk	835283-E
O-Ring, for M8 metal shell, 10x1	NBR	black	-	Bulk	834898-E

M8 - ASSEMBLY KIT

Product Specification



Ordering Information

No. of Pins	Assembly Height	Coding	Configuration	Termination	Packaging	Part Number
4	13 mm	A	kit, male, metal shell, o-ring 10x1	SMT	Bag	294941-E

M8 - QUICK TERMINATION FOR ASSEMBLY

Product Specification



Ordering Information

No. of Pins	Coding	Configuration	Termination	Packaging	Part Number
4	A	M8, female	IDC	Bag	254764-E

M12 - FEMALE

Product Specification



Ordering Information

No. of Pins	Assembly Height	Coding	Configuration	Shield	Termination	Packaging	Part Number
4	9/13 mm	A	M12, female	no	SMT	Tape and reel	454003-E
4	9/13 mm	A	M12, female, machined contacts	no	SMT	Tape and reel	474053-E
4	9/13 mm	A	M12, female	no	SMT	Bulk	284322-E
4	9/13 mm	A	M12, female, machined contacts	no	THR	Tape and reel with pad	515928-E
4	9/13 mm	D	M12, female	no	SMT	Bulk	234040-E
4	9/13 mm	D	M12, female	no	SMT	Tray	454466-E
4	9/13 mm	D	M12, female	no	THR	Tape and reel with pad	474522-E
4	9/13 mm	D	M12, female	no	SMT	Tape and reel	484574-E
4	9/13 mm	D	M12, female	no	THR	Tape and reel	494083-E
4	9/13 mm	D	M12, female	no	SMT	Tape and reel	534075-E
5	9/13 mm	A	M12, female	no	SMT	Tape and reel	224064-E
5	9/13 mm	A	M12, female	no	SMT	Tape and reel with pad	454950-E
5	9/13 mm	A	M12, female, machined contacts	no	SMT	Tape and reel	354702-E
5	9/13 mm	A	M12, female, machined contacts	no	SMT	Tape and reel with pad	484896-E
5	9/13 mm	A	M12, female, machined contacts	no	THR	Tape and reel with pad	494145-E
5	9/13 mm	A	M12, female	no	SMT	Bulk	194781-E
5	9/13 mm	A	M12, female	no	SMT	Tape and reel	354098-E
5	9/13 mm	A	M12, female	no	THR	Tape and reel	494081-E
5	9/13 mm	B	M12, female	no	THR	Tape and reel with pad	534185-E
5	9/13 mm	B	M12, female	no	THR	Tape and reel	494562-E
5	9/13 mm	B	M12, female	no	SMT	Tape and reel	254206-E
5	9/13 mm	B	M12, female	no	SMT	Tape and reel with pad	454951-E
5	9/13 mm	B	M12, female, machined contacts	no	SMT	Tape and reel	384891-E

M12 - FEMALE

Ordering Information

No. of Pins	Assembly Height	Coding	Configuration	Shield	Termination	Packaging	Part Number
8	9/13 mm	A	M12, female	no	SMT	Tape and reel	354131-E
8	9/13 mm	A	M12, female	no	SMT	Tape and reel with pad	454952-E
8	9/13 mm	A	M12, female, machined contacts	no	SMT	Tape and reel	394305-E
8	9/13 mm	A	M12, female, machined contacts	no	SMT	Tape and reel with pad	494166-E
8	9/13 mm	A	M12, female	no	SMT	Bulk	254310-E
8	9/13 mm	A	M12, female	no	THR	Tape and reel	474681-E
12	9/13 mm	A	M12, female, machined contacts	no	SMT	Tape and reel with pad	484074-E
17	9/13 mm	A	M12, female, machined contacts	no	SMT	Tape and reel with pad	484076-E

M12 - MALE

Product Specification



Ordering Information

No. of Pins	Assembly Height	Coding	Configuration	Shield	Termination	Packaging	Part Number
3	9 mm	A	M12, male, o-ring	no	SMT	Bulk	454066-E
4	9 mm	A	M12, male	no	SMT	Bulk	254859-E
4	9 mm	A	M12, male	no	SMT	Tape and reel	284809-E
4	9 mm	A	M12, male	no	SMT	Tape and reel with pad	484790-E
4	9 mm	A	M12, male, o-ring	no	SMT	Tape and reel	494167-E
4	9 mm	A	M12, male, o-ring	no	SMT	Tape and reel with pad	494013-E
4	13 mm	A	M12, male	no	SMT	Tape and reel	494020-E
4	9 mm	A	M12, male, o-ring	no	SMT	Tape and reel	534073-E
4	9 mm	B	M12, male	no	SMT	Tape and reel with pad	494705-E
4	9 mm	UNI	M12, male, o-ring	no	THR	Bulk	384812-E
4	13 mm	A	M12, male	no	SMT	Bulk	254188-E
4	13 mm	A	M12, male	no	SMT	Tray	454829-E
4	13 mm	B	M12, male	no	SMT	Tape and reel with pad	494577-E
4	13 mm	B	M12, male	no	SMT	Tape and reel with pad	244798-E
4	9 mm	A	M12, male, o-ring	no	SMT	Tape and reel	494520-E
4	9 mm	T	M12, male	yes	SMT	Tape and reel	474580-E
4	9 mm	T	M12, male	no	SMT	Tape and reel with pad	494729-E
5	9 mm	A	M12, male, o-ring	no	SMT	Tape and reel	284740-E
5	9 mm	A	M12, male	no	SMT	Tape and reel	494335-E
5	9 mm	A	M12, male	no	SMT	Tape and reel with pad	484924-E
5	9 mm	A	M12, male	yes	SMT	Tape and reel	464912-E
5	13 mm	A	M12, male	no	SMT	Tape and reel with pad	494068-E
5	13 mm	A	M12, male	no	SMT	Bulk	244934-E

M12 - MALE

Ordering Information

No. of Pins	Assembly Height	Coding	Configuration	Shield	Termination	Packaging	Part Number
5	9 mm	A	M12, male, o-ring	no	SMT	Bulk	354132-E
5	9 mm	UNI	M12, male, o-ring	no	THR	Bulk	384814-E
5	9 mm	A	M12, male	no	SMT	Tape and reel with pad	484719-E
5	9 mm	UNI	M12, male	no	THR	Tray	494100-E
5	9 mm	UNI	M12, male, o-ring	no	SMT	Tape and reel with hood	494981-E
5	9 mm	B	M12, male	no	SMT	Tape and reel	354130-E
5	9 mm	B	M12, male, o-ring	no	SMT	Tape and reel with pad	515129-E
5	9 mm	B	M12, male	no	SMT	Bulk	254319-E
5	13 mm	A	M12, male	no	SMT	Bulk	244790-E
5	13 mm	A	M12, male	no	SMT	Bulk	364767-E
5	13 mm	A	M12, male	no	THR	Bulk	374352-E
5	13 mm	A	M12, male	no	SMT	Tray	454828-E
5	13 mm	A	M12, male	no	THR	Bulk	464834-E
5	13 mm	A	M12, male	no	THR	Tray	484118-E
5	13 mm	A	M12, male	no	SMT	Tray	484967-E
5	13 mm	B	M12, male	no	SMT	Bulk	374947-E
8	9 mm	A	M12, male	no	SMT	Tape and reel	284810-E
8	9 mm	A	M12, male	no	SMT	Tape and reel with pad	464676-E
8	9 mm	A	M12, male	yes	SMT	Tape and reel	464800-E
8	13 mm	A	M12, male	no	SMT	Tape and reel with pad	494376-E
8	13 mm	A	M12, male	no	THR	Tray	484156-E
8	9 mm	A	M12, male, o-ring	no	SMT	Bulk	254317-E
8	9 mm	A	M12, male	no	SMT	Tray	454464-E
8	13 mm	A	M12, male	no	SMT	Bulk	394331-E
8	9 mm	A	M12, male, o-ring	no	SMT	Tape and reel	494524-E
12	9 mm	A	M12, male	no	SMT	Tape and reel	484784-E
12	9 mm	A	M12, male	yes	SMT	Tape and reel	454643-E
12	9 mm	A	M12, male	yes	SMT	Tape and reel with pad	494518-E

M12 - MALE FOR DIRECT INTEGRATION

Product Specification



Ordering Information

No. of Pins	Assembly Height	Configuration	Shield	Termination	Packaging	Part Number
4	9 mm	M12, male	no	THR	Tray	364781-E
4	9 mm	M12, male	no	SMT	Tray	394339-E
4	9 mm	M12, male	no	SMT	Tape and reel with cap	474329-E
5	9 mm	M12, male	no	THR	Tray	364779-E
5	9 mm	M12, male	no	SMT	Tray	394337-E
5	9 mm	M12, male	no	SMT	Tape and reel with cap	474331-E
8	9 mm	M12, male	no	SMT	Tray	364777-E
8	9 mm	M12, male	no	SMT	Tape and reel with cap	515632-E

M12 - ACCESSORIES

Product Specification



Ordering Information

Configuration	Material	Color	Assembly Height	Packaging	Part Number
Metal shell, for M12 female connectors	CuZn nickel plated	-	9 mm	Bulk	394828-E
Metal shell, for M12 female connectors	CuZn nickel plated	-	13 mm	Bulk	394847-E
Metal shell, for M12 male connectors	CuZn nickel plated	-	9 mm	Bulk	464272-E
Metal shell, for M12 male connectors	CuZn nickel plated	-	13 mm	Bulk	284377-E
Metal shell, for M12 male connectors, for counternut	CuZn nickel plated	-	13 mm	Bulk	394863-E
Counternut, M14x1	-	-	-	Bulk	354003-E
O-Ring, for M12 male connectors DI, 7x1.5	NBR	black	-	Bulk	835243-E
O-Ring, for M12 male connectors DI, 7x1.5	FKM	green	-	Bulk	835299-E
O-Ring, for M12 metall shell, 14x1	NBR	black	-	Bulk	834899-E
O-Ring, for M12 metall shell, 14x1	FKM	black	-	Bulk	835677-E
O-Ring, for M12 female connectors, 7x1	FKM	black	-	Bulk	835284-E
Protective cap, For female connectors, M12x1	PE-HD	black	-	Bulk	225507-E

M12 - ASSEMBLY KIT

Product Specification



Ordering Information

No. of Pins	Assembly Height	Coding	Configuration	Termination	Packaging	Part Number
4	13 mm	D	kit, female, metal shell, o-ring 14x1, o-ring 7x1	SMT	Bag	225114-E
8	13 mm	A	kit, female, metal shell, o-ring 14x1, o-ring 7x1	SMT	Bag	294937-E

M12 - QUICK TERMINATION

Product Specification



Ordering Information

No. of Pins	Coding	Configuration	Termination	Packaging	Part Number
4	A	M12, female	IDC	Bag	254770-E

M12 ETHERNET-FEMALE

Product Specification



Ordering Information

No. of Pins	Assembly Height	Coding	Configuration	Shield	Termination	Packaging	Part Number
4	9/13 mm	D	M12, female	no	SMT	Tape and reel	234041-E
4	9/13 mm	D	M12, female	no	SMT	Tape and reel with pad	454949-E
4	9/13 mm	D	M12, female, machined contacts	no	SMT	Tape and reel	364175-E
4	9/13 mm	D	M12, female, machined contacts	no	SMT	Tape and reel with pad	474665-E
4	9/13 mm	D	M12, female, machined contacts	no	THR	Tape and reel with pad	484944-E
4	9/13 mm	D	M12, female, machined contacts	yes	SMT	Tape and reel	484936-E
4	9/13 mm	D	M12, female, machined contacts	yes	SMT	Tape and reel with pad	484937-E

M12 ETHERNET-FEMALE, GIGABIT

Product Specification



Ordering Information

No. of Pins	Assembly Height	Coding	Configuration	Shield	Termination	Packaging	Part Number
8	9/13 mm	X	M12, female	yes	SMT/THR	Tape and reel	474771-E
8	9/13 mm	X	M12, female	yes	SMT/THR	Tape and reel with pad	394811-E

M12 ADAPTER

Product Specification



Ordering Information

No. of Pins	Coding	Configuration	Packaging	Part Number
4	T	M12, male - M12, female	air cushion foil	484023-E
4	A	M12, male - M12, female	air cushion foil	494094-E

M8/M12 T-COUPLER

Product Specification



Ordering Information

No. of Pins	Coding	Configuration	Packaging	Part Number
5/5/5	A	1 x M12, male, 5 pin - 2 x M12, female, 5 pin, CAN / DeviceNet	Bag	394892-E

M12 PANEL FEED-THROUGH

Product Specification



Ordering Information

No. of Pins	Coding	Configuration	Packaging	Part Number
5	A	M12, male - M12, female	Bag	254780-E

M8/M12 - RIGHT ANGLE CONNECTORS

- extremely space saving due to its placing on PCB central axis
- identical layout for male and female version
- 4 - 8 pin configuration
- gold plated contacts
- IP 65/67 mated and locked condition
- suitable for potting after assembly due to optional O-ring
- male and female can be used with housings which provide integrated M12 threads
- optional 360° shield ring
- integrated brackets for 3 different frequently-used PCB thicknesses, 1.0 / 1.6 / 2.0 mm
- cylindrical base version, which is also usable for M12 sensor pipes
- high Comparative Tracking Index (CTI) value of 600 for rough environmental applications
- UL listed polymer plastic
- early mate last break option for pin 5
- mating side according IEC 61076 - 2 - 101
- A-, B- and D-Coding
- UL E84703 listed

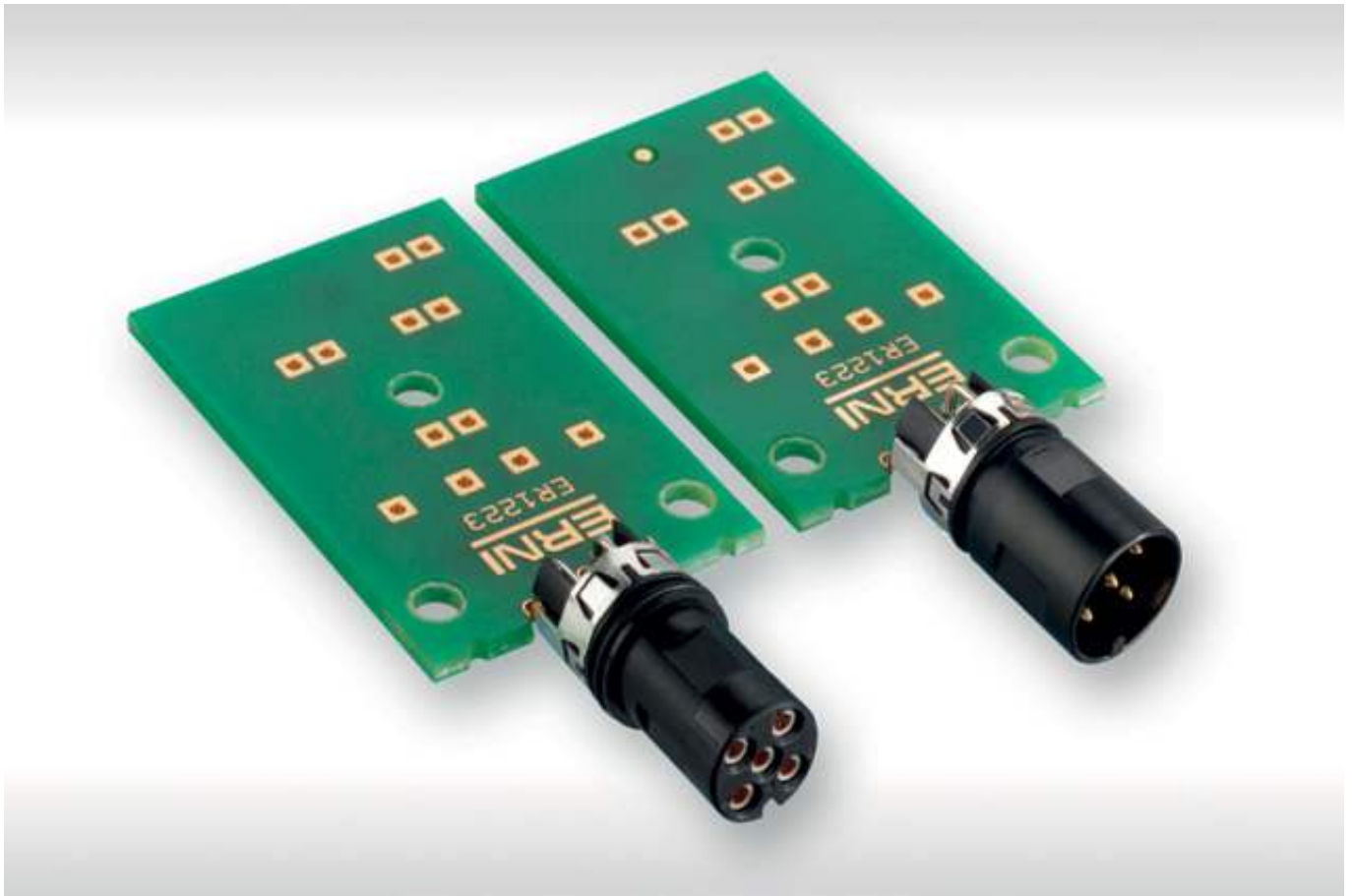

GENERAL

Standard Solutions

Processing Features:

- first M12 90° version which has capability for automated pick and place assembly
- T&R packaging
- integrated pick & place area
- pegs and integrated PCB support areas ensure a secure position while soldering
- extremely robust due to pins soldered on top and bottom side of the PCB
- lead-free reflow compatible
- rear mounting of the final assembled PCB in a housing

For technical data refer to ERNI document 225407

Sensor Pipe Solutions

This new development is a product that has never been existed before. It completes the ERNI M12 connector range with a M12 male connector which targets specifically the sensor industry, where mostly one single male connector is used for a device. To save cost and ensure high quality levels, the connector can be fully handled within a standard SMT assembly line.

Mating side according IEC 61076 - 2 - 101.

Design Features:

- extremely short version 14 mm length
- specially designed for M12 sensor pipes
- front mounting of final assembled PCB into the sensor pipe
- sealing option with O-ring
- versions with anti twist protection
- additional features see standard version



ASSEMBLY AND SOLDER RECOMMENDATIONS

PCB Thickness

The connector has integrated PCB support points, which are able to adapt to the 3 frequently-used PCB thicknesses. The thickest PCB could be 2.0 mm followed by the favorite 1.6 mm and further followed by the thinnest 1.0 mm.

Note: Also other thicknesses in between of the mentioned range can be used, if the non centric position of the connector is taken into account.

The support points have to be considered according to the chosen PCB thickness, see drawing left hand side. The PCB has to be designed to provide those supports. For exact dimensions, mechanical CAD-files can be provided.

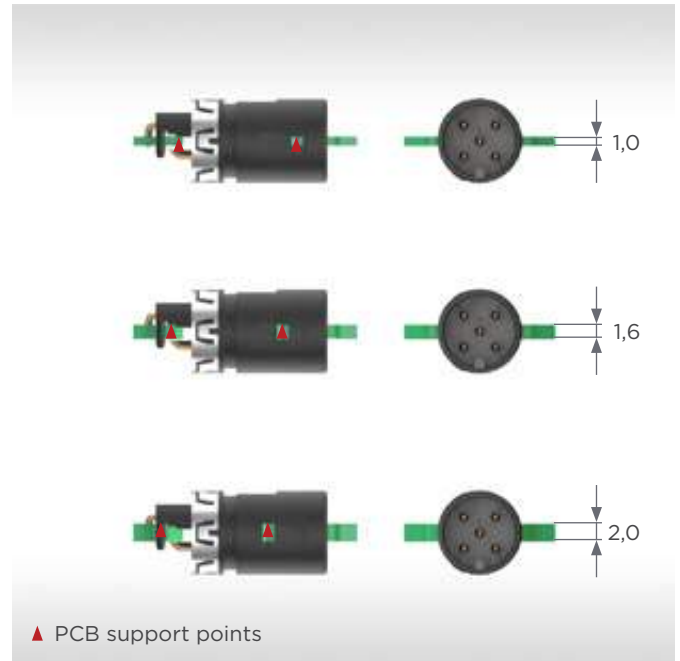

Assembly Process

Printing of solder paste

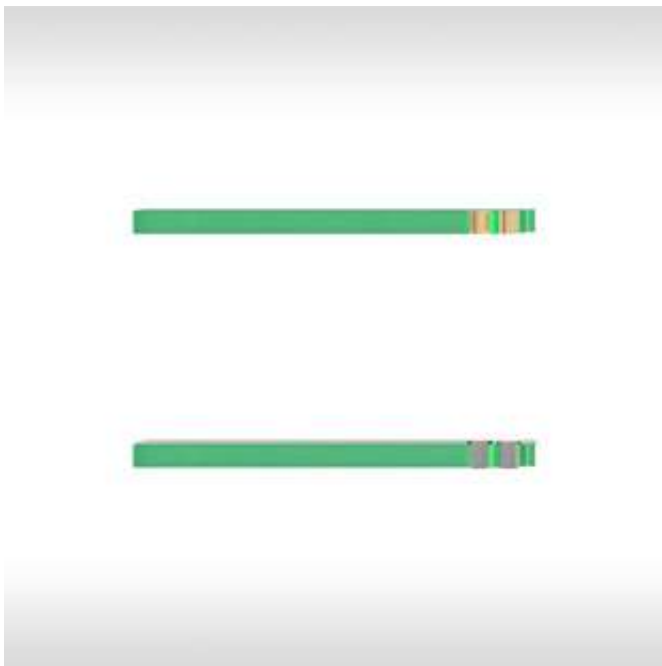

Automated Assembly

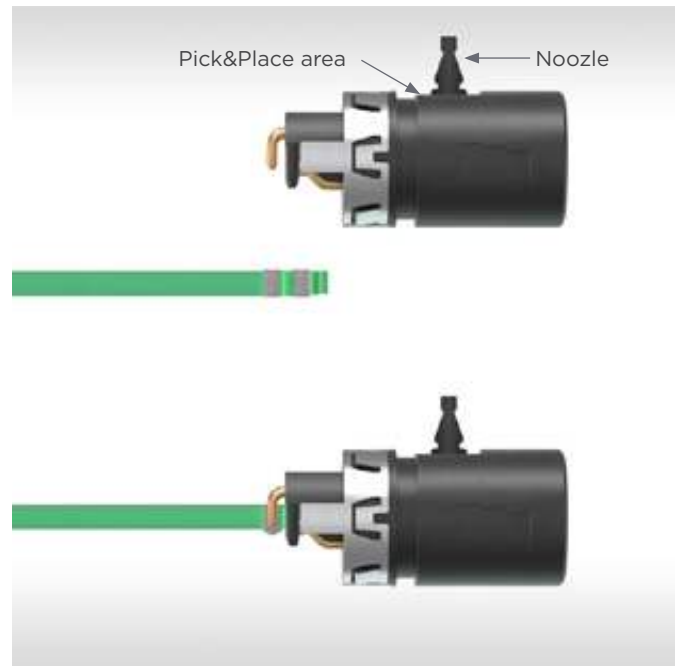

Comments:

- generally a certain mounting force is required when using the THR solder process
- special nozzles may be necessary
- machine capability must be checked upfront

DIMENSIONS AND ASSEMBLY RECOMMENDATION STANDARD

M12 Male (5-Pin) with Erni Locking Shell

Gewinde-Löcher / Thread holes

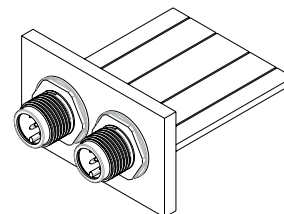
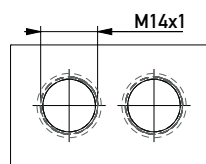
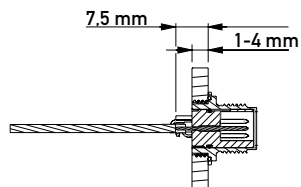
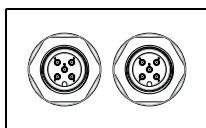

Standard-Löcher / Standard holes

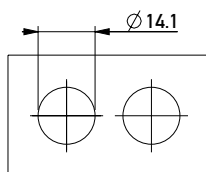
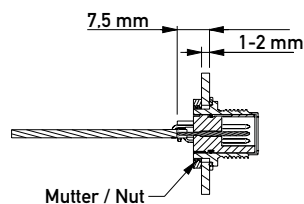
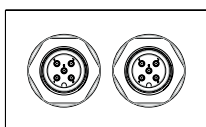

Montageloch für Verdrehschutz / Assembly hole for twist protection

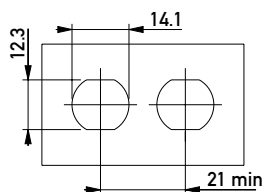
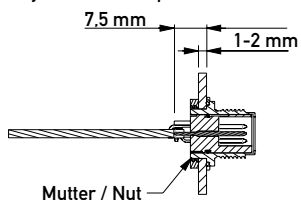
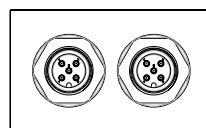

M12 Female (5-Pin) with Erni Locking Shell

Gewinde-Löcher / Thread holes

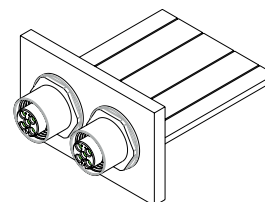
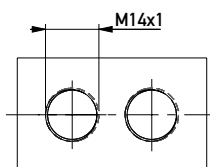
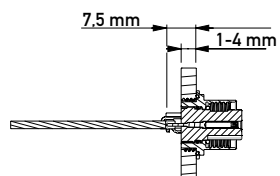
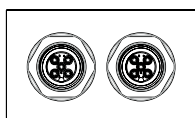

Standard-Löcher / Standard holes

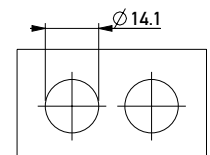
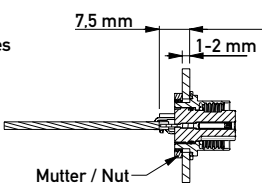
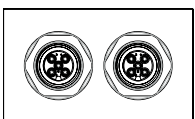

Montageloch für Verdrehschutz / Assembly hole for twist protection

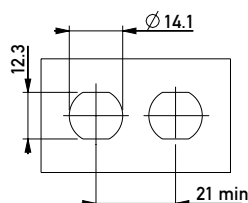
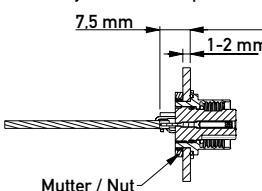
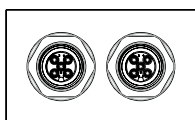

See product drawing or recommendations for use the M12 90° connectors together with housings which have already an integrated M12 thread (ERNI document 225406).

ASSEMBLY EXAMPLE FOR SENSOR PIPE

Rear Mounting Sensor Pipe

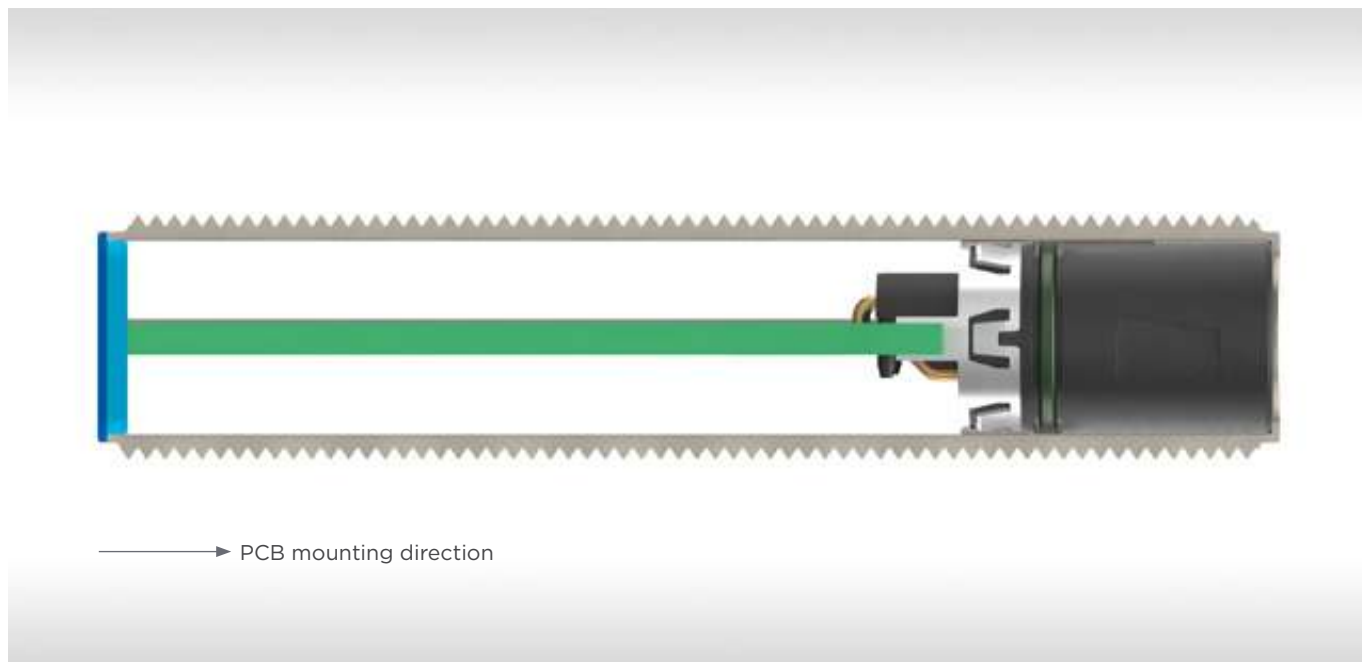

Front Mounting Sensor Pipe

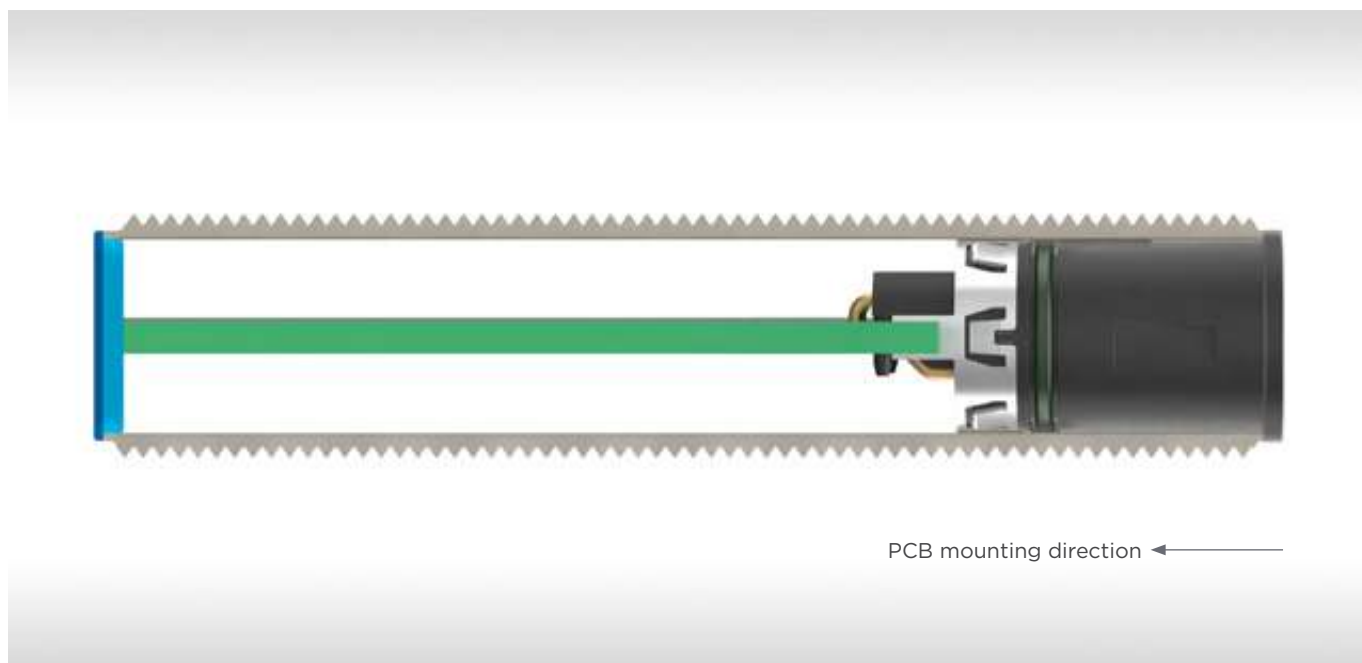

LAYOUT, SHIELDING, PACKAGING AND SEALING OPTIONS

Layout Recommendation

Sensor pipe application

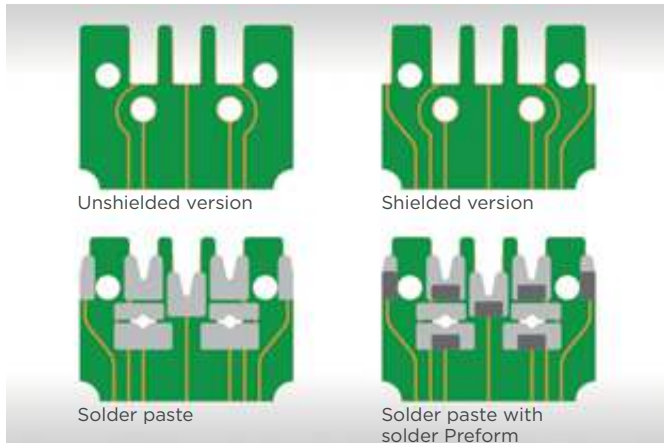

Standard application



Shielding

The optional shield ring is soldered with two pins to the PCB. Electrical contact to the locking shell is given by three contact tongues placed at the outer contour of the shield ring.

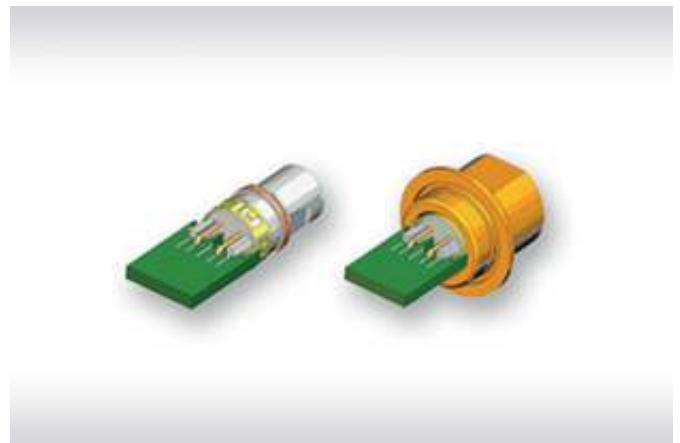

Packaging

Tape on reel packaging. Packaging unit: 250 Pcs.

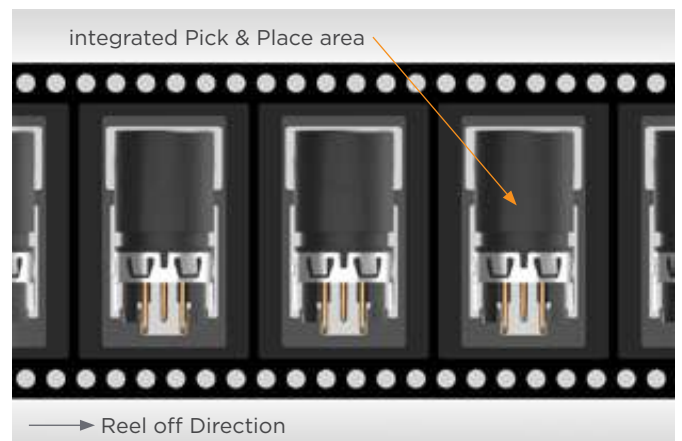
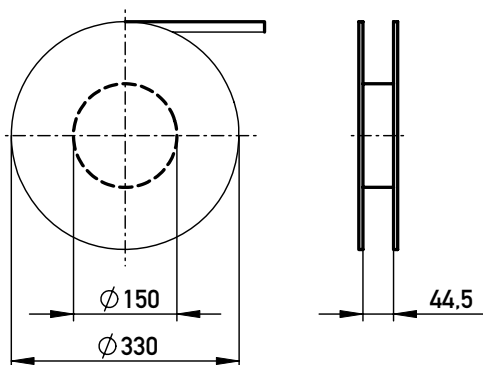

LAYOUT, SHIELDING, PACKAGING AND SEALING OPTIONS

Sealing Options M12 90° Male Connectors

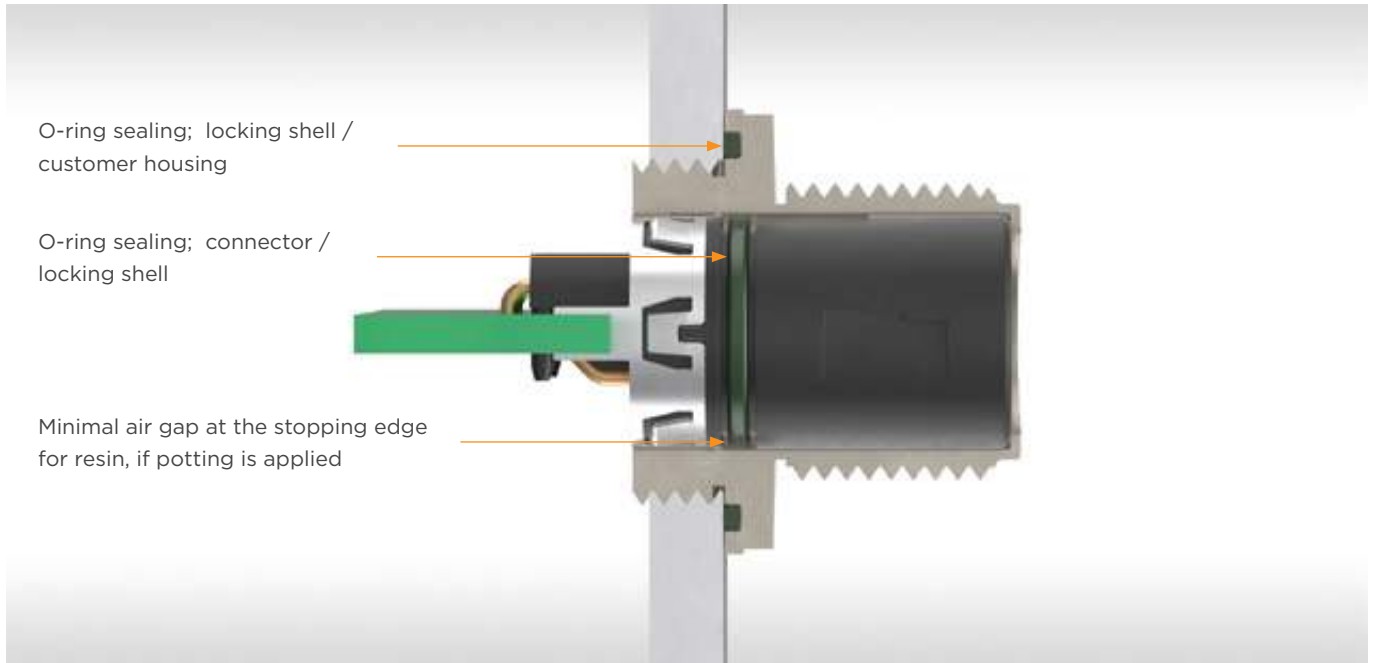

Sealing Options M12 90° Female Connectors

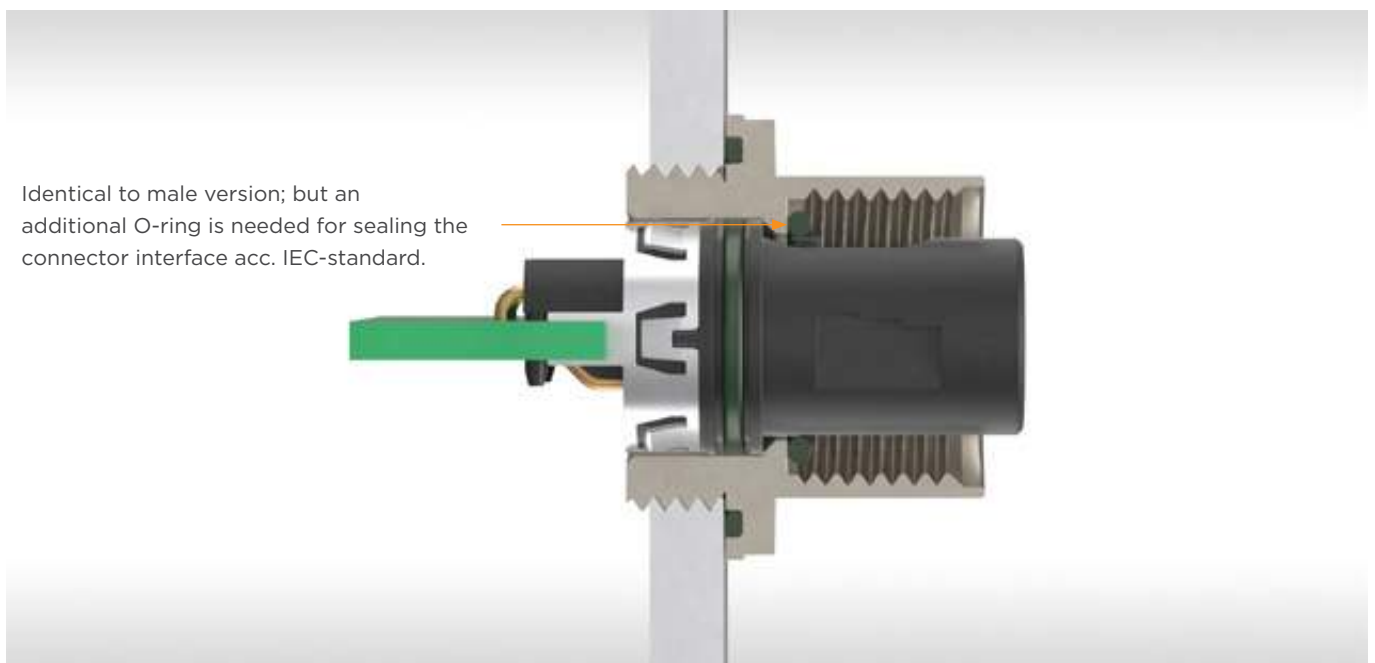

M8 FEMALE CONNECTORS FOR SENSOR PIPE APPLICATIONS

Product Specification

- right angle female
- rear mount



Ordering Information End Assembly Front Mount

No. of Pins	Coding	O-Ring	Shield	Part Number
4	A	no	yes	235255-E

MALE CONNECTORS FOR STANDARD APPLICATIONS

Product Specification

- right angle male
- rear mount
- with or without O-ring
- 4, 5 and 8-pin
- shielded and unshielded versions



Ordering Information End Assembly Rear Mount

No. of Pins	Coding	Loaded Pins	O-Ring	Part Number unshielded	Part Number shielded
4	A	1, 2, 3, 4	no	225252-E	225255-E
4	A	1, 2, 3, 4	yes	235230-E	235171-E
4	A	1, 2, 3, 4	yes		235268-E
4	UNI	1, 2, 3, 4	yes	235221-E	
5	A	1, 2, 3, 4, 5	no	225251-E	225254-E
5	A	1, 2, 3, 4, 5	yes	225456-E	235165-E
5	A	1, 2, 3, 4, 5v	no		225256-E
5	B	1, 2, 3, 4, 5	no		225260-E
8	A	1, 2, 3, 4, 5, 6, 7, 8	no	225294-E	225295-E
8	A	1, 2, 3, 4, 5, 6, 7, 8	yes	225454-E	235045-E

v = early mate last break

Ordering Information End Assembly Rear Mount and Additional Anti Twist Protection

No. of Pins	Coding	Loaded Pins	O-Ring	Part Number unshielded	Part Number shielded
8	A	1, 2, 3, 4, 5, 6, 7, 8	yes	225614-E	-

Used with locking shell 225635.

Optional Accessories

Description	Usage	Part Number
O-Ring, 7.2 x 0.8, Viton	sealing option between connector and locking shell	225360-E
M12Locking shell	for male connectors	225361-E
O-Ring, 14 x 1	sealing option between housing and locking shell	834899-E
Counternut	for locking shell	354003-E

MALE CONNECTORS FOR STANDARD APPLICATIONS

Product Specification

- right angle male
- rear mount, DI
- with or without O-ring
- 4, 5 and 8-pin



Ordering Information End Assembly Rear Mount, DI Type

No. of Pins	Coding	Loaded Pins	O-Ring	Part Number
4	by customer	1, 2, 3, 4	no	225267-E
4	by customer	1, 2, 3, 4	yes	235042-E
5	by customer	1, 2, 3, 4, 5	no	225266-E
8	by customer	1, 2, 3, 4, 5, 6, 7, 8	no	225297-E

v = early mate last break

Optional Accessories

Description	Usage	Part Number
O-Ring, 7,2 x 0,8, Viton	sealing option between connector and customer housing	225360-E

O-Ring can be used in reflow solder process.

MALE CONNECTORS FOR SENSOR PIPE APPLICATIONS

Product Specification

- right angle male
- front mount
- with O-ring
- 4, 5 and 8-pin
- shielded and unshielded versions



Ordering Information End Assembly Front Mount

No. of Pins	Coding	Loaded Pins	O-Ring	Part Number unshielded	Part Number shielded
4	A	1, 2, 3, 4	yes	225243-E	225247-E
8	A	1, 2, 3, 4, 5, 6, 7, 8	yes	225291-E	225292-E

v = early mate last break

Ordering Information End Assembly Front Mount, Anti Twist Version

No. of Pins	Coding	Loaded Pins	O-Ring	Part Number unshielded	Part Number shielded
8	A	1, 2, 3, 4, 5, 6, 7, 8	yes	225521-E	225522-E

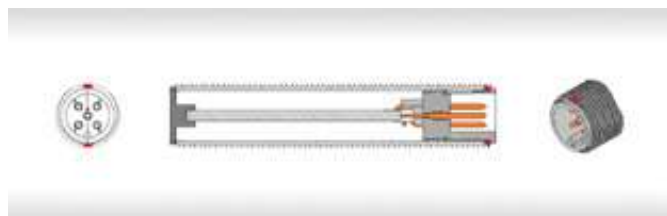

Ordering Information End Assembly Front Mount, Snap-In Version

No. of Pins	Coding	Loaded Pins	O-Ring	Part Number unshielded	Part Number shielded
4	A	1, 2, 3, 4	yes	235265-E	-
5	A	1, 2, 3, 4, 5	yes	225459-E	-

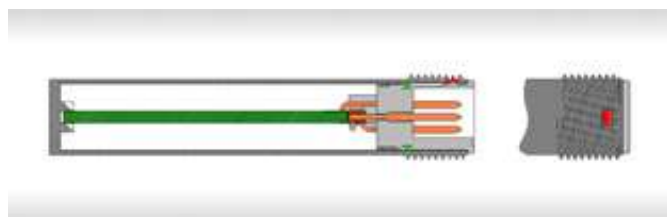

FEMALE CONNECTORS FOR STANDARD APPLICATIONS

Product Specification

- right angle female
- rear mount
- with or without O-ring
- 4, 5 and 8-pin
- shielded and unshielded versions



Ordering Information End Assembly Rear Mount

No. of Pins	Coding	Loaded Pins	O-Ring	Part Number unshielded	Part Number shielded
4	A	1, 2, 3, 4	yes	225458-E	-
4	D	1, 2, 3, 4	no	-	225284-E
4	D	1, 2, 3, 4	yes	-	235190-E
5	A	1, 2, 3, 4, 5	no	225273-E	225275-E
5	A	1, 2, 3, 4, 5	yes	225457-E	235164-E
8	A	1, 2, 3, 4, 5, 6, 7, 8	no	225300-E	225301-E
8	A	1, 2, 3, 4, 5, 6, 7, 8	yes	225616-E	-

Ordering Information End Assembly Rear Mount and Additional Anti Twist Protection

No. of Pins	Coding	Loaded Pins	O-Ring	Part Number unshielded	Part Number shielded
8	A	1, 2, 3, 4, 5, 6, 7, 8	yes	225615-E	-

Used with locking shell 225636.

Optional Accessories

Description	Usage	Part Number
O-Ring, 7.2 x 0.8, Viton	sealing option between connector and locking shell	225360-E
O-Ring, 7 x 1, Viton	sealing option cable side	835284-E
M12 Locking shell	for female connectors	225362-E
O-Ring, 14 x 1	sealing option between housing and locking shell	834899-E
M12 Protection cap	for female connectors	374343-E
Counternut	for locking shell	354003-E

FEMALE CONNECTORS FOR STANDARD APPLICATIONS

Product Specification

- right angle female
- rear mount, DI
- with or without O-ring
- 4, 5 and 8-pin



Ordering Information End Assembly Rear Mount, DI Typ

No. of Pins	Coding	Loaded Pins	O-Ring	Part Number unshielded
4	by customer	1, 2, 3, 4	no	225287-E
5	by customer	1, 2, 3, 4, 5	no	225286-E

Optional Accessories

Description	Usage	Part Number
O-Ring, 7,2 x 0,8, Viton	sealing option between connector and customer housing	225360-E
O-Ring, 7 x 1, Viton	sealing option cable side	835284-E

O-Ring 225360 can be used in reflow solder process.

ASSEMBLY

Process Images

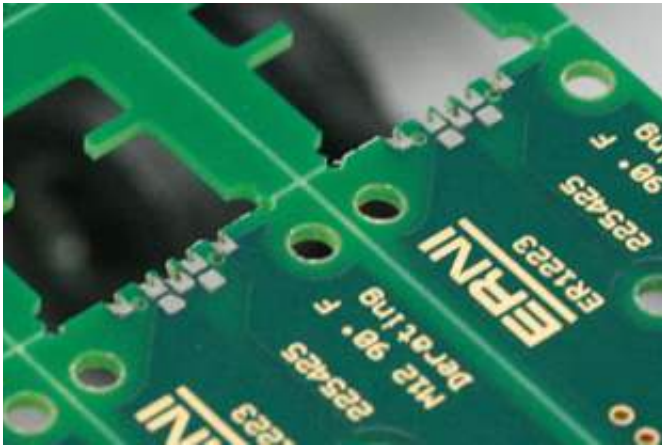

PCB with solder paste

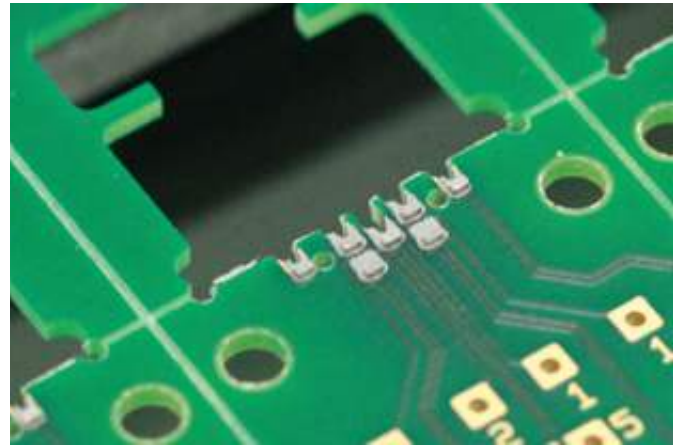

PCB with solder paste and pre-form

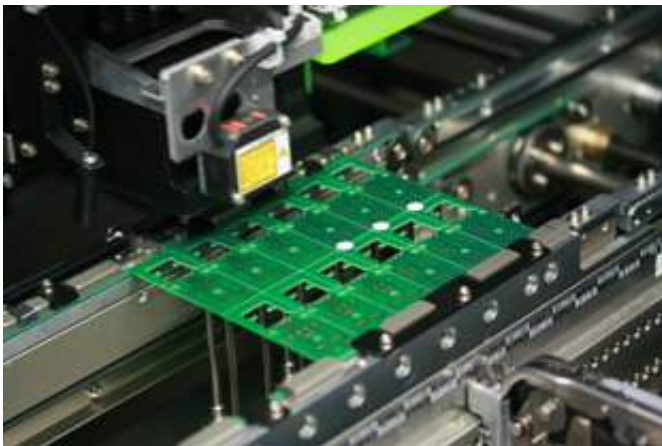

Multiple printed pcb in assembly machine

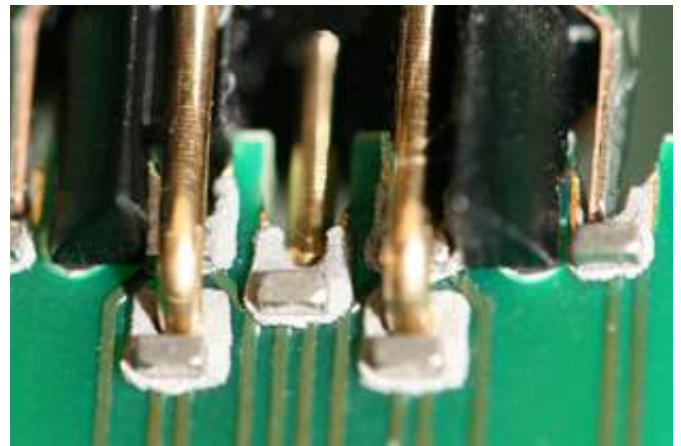

Connector placed into solder paste



Male solder joints



Female solder joints



ASSEMBLY

Product Images

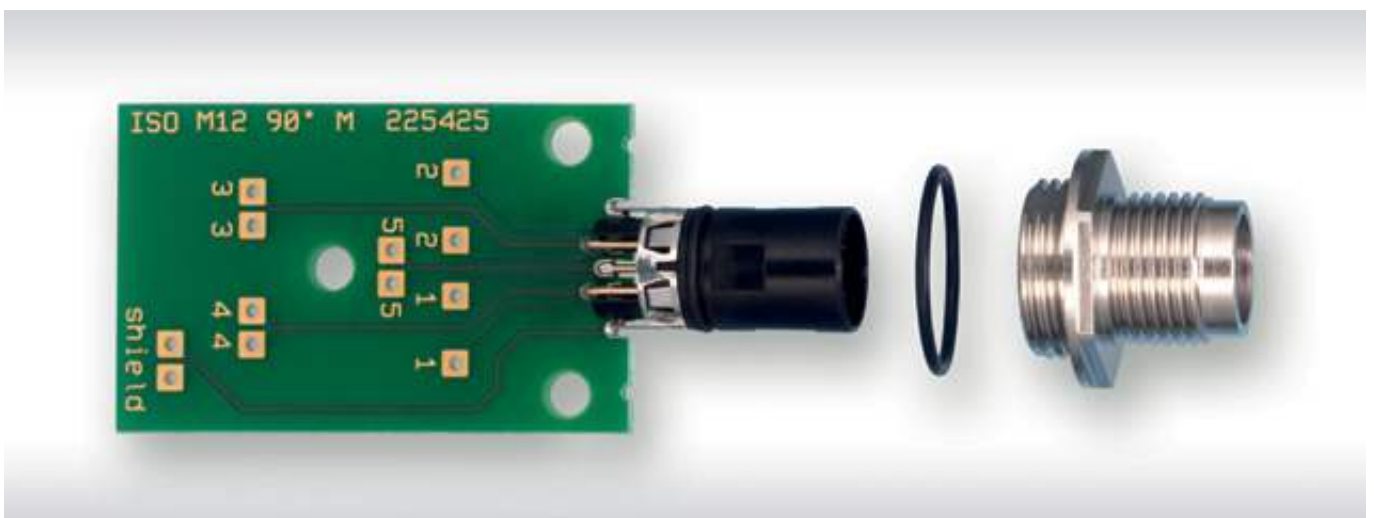

Connect With Us

We make it easy to connect with our experts and are ready to provide the support you need. Visit www.te.com/support to chat with a Product Information Specialist.

te.com

2022 TE Connectivity. All Rights Reserved.

TE Connectivity, TE connectivity (logo) ERNI and Every Connection Counts are trademarks owned or licensed by the TE Connectivity family of companies. All other logos, products and/or company names referred to herein might be trademarks of their respective owners.

The information given herein, including drawings, illustrations and schematics which are intended for illustration purposes only, is believed to be reliable. However, TE Connectivity makes no warranties as to its accuracy or completeness and disclaims any liability in connection with its use. TE Connectivity's obligations shall only be as set forth in TE Connectivity's Standard Terms and Conditions of Sale for this product and in no case will TE Connectivity be liable for any incidental, indirect or consequential damages arising out of the sale, resale, use or misuse of the product. Users of TE Connectivity products should make their own evaluation to determine the suitability of each such product for the specific application.

074554-E JS 02/23

CATALOG

TE Connectivity

ERNI Electronics GmbH & Co. KG
a TE Connectivity Ltd. company
Seestraße 9
73099 Adelberg
Germany

Tel +49 7166 50-0
www.te.com
www.erni.com