

TPS40400 Buck Controller Evaluation Module User's Guide



Table of Contents

1 Introduction	2
2 Description	3
2.1 Typical Applications.....	3
2.2 Features.....	3
3 Electrical Performance Specifications	4
4 Schematic	5
5 Test Setup	6
5.1 Test and Configuration Software.....	6
5.2 Test Equipment.....	7
5.3 Recommended Test Setup.....	8
5.4 USB Interface Adapter and Cable.....	9
6 EVM Configuration Using the Fusion GUI	11
6.1 Configuration Procedure.....	11
6.2 Fusion GUI Screenshots.....	11
7 Test Procedure	14
7.1 Line/Load Regulation and Efficiency Measurement Procedure.....	14
7.2 Control Loop Gain and Phase Measurement Procedure.....	14
7.3 List of Test Points.....	15
7.4 Equipment Shutdown.....	15
8 Performance Data and Typical Characteristic Curves	16
8.1 Efficiency.....	16
8.2 Load Regulation.....	16
8.3 Load Transients 1.....	17
8.4 Load Transient 2.....	17
8.5 Load Transient 3.....	18
8.6 Input and Output Ripple.....	18
8.7 Switch Node and HDRV.....	19
8.8 V_{IN} Turn On.....	19
8.9 Enable ON / OFF.....	20
8.10 Turn ON with 92% (1.1V) Pre-bias.....	21
8.11 TPS40400EVM-351 Bode Plot (20-A output).....	21
9 EVM Assembly Drawing and PCB Layout	22
10 List of Materials	26
11 Revision History	27

1 Introduction

The TPS40400EVM-351 evaluation module (EVM) uses the TPS40400. The TPS40400 is a synchronous buck controller that operates from a nominal 3.0-V to 20-V supply. This controller is an analog PWM controller that allows programming and monitoring via the PMBus interface.

2 Description

The TPS40400EVM-351 is designed to use a regulated 12-V bus to produce a regulated 1.2-V output at up to 20 A of load current. The TPS40400EVM-351 is designed to demonstrate the TPS40400 in a typical low-voltage application while providing a number of test points to evaluate the performance of the TPS40400.

2.1 Typical Applications

- Smart Power Systems
- Power Supply Modules
- Communications Equipment
- Computing Equipment

2.2 Features

The TPS40400EVM-351 features:

- Regulated 1.2-V output, marginable and trimmable via the PMBus interface
- 20-A DC steady state output current
- Programmable soft start via the PMBus interface
- Programmable enable function via the PMBus interface
- Programmable over-current warning and fault limit along with the condition response via the PMBus interface
- Programmable over-voltage warning and fault limit along with the condition response via the PMBus interface
- Programmable high and low output margin voltages with a maximum range of +/-25% of nominal output voltage
- Convenient test points for probing critical waveforms

3 Electrical Performance Specifications

Table 3-1. TPS40400EVM-351 Electrical Performance Specifications

PARAMETER	TEST CONDITIONS	MIN	TYP	MAX	UNITS
Input Characteristics					
Voltage range	V _{IN}	8	12	14	V
Maximum input current	V _{IN} = 8 V, I _O = 20 A		3.5		A
No load input current	V _{IN} = 14 V, I _O = 0 A with auto skip mode		50		mA
Output Characteristics					
Output voltage, V _{OUT}			1.2		V
Output voltage regulation	Line regulation(V _{IN} = 8 V - 14 V)		0.5%		
	Load regulation(V _{IN} = 12 V, I _O = 0 A - 20 A)		0.5%		
Output voltage ripple	V _{IN} = 12 V, I _O = 20 A		30		mVpp
Output load current		0		20	A
Output over current			25		
Systems Characteristics					
Switching frequency			608		kHz
Peak efficiency	V _{IN} = 12 V, 1.2 V / 12 A, F _{SW} = 300 kHz		89.6%		
Full-load efficiency	V _{IN} = 12 V, 1.2 V / 20 A		88.2%		
Operating temperature			25		°C

4 Schematic

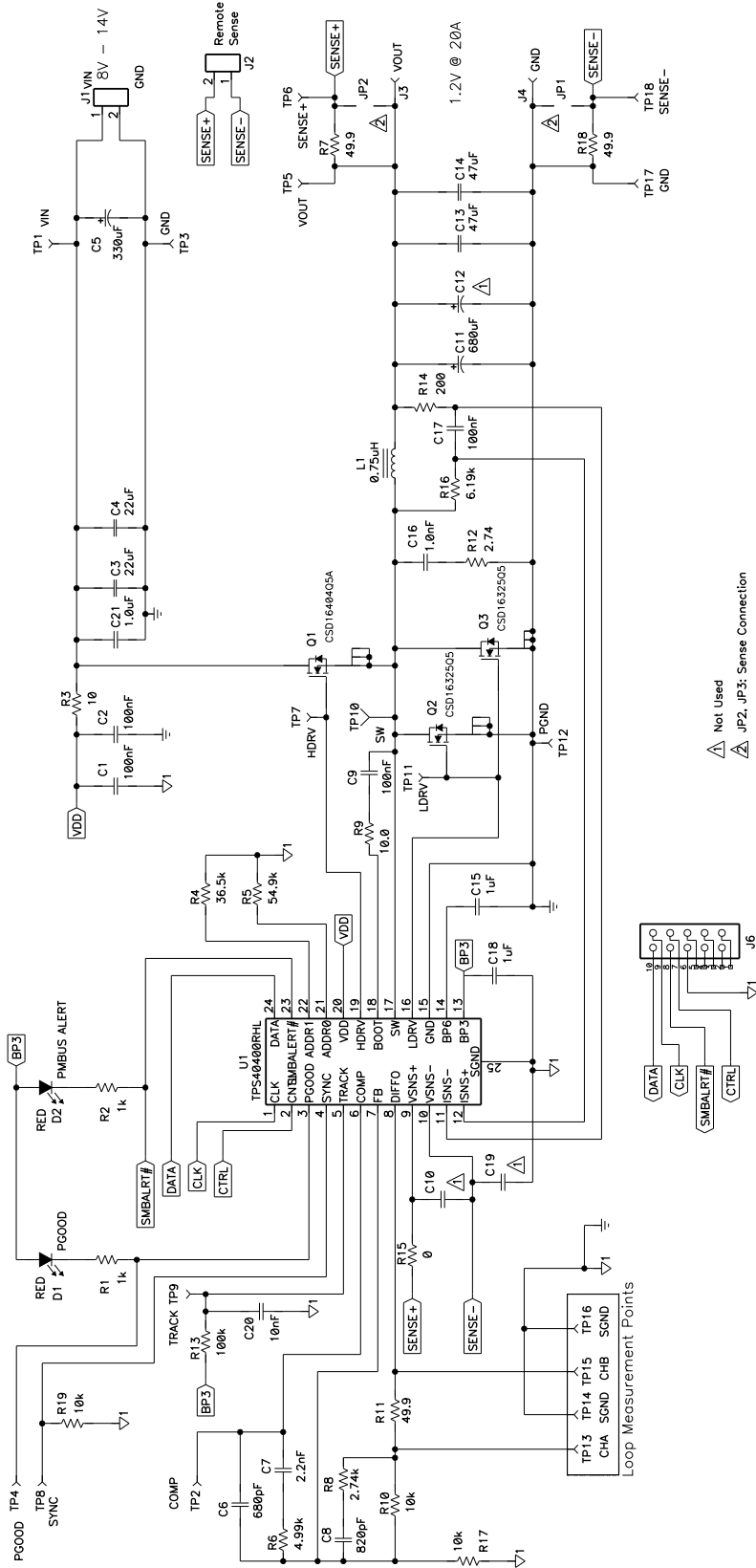

Figure 4-1. TPS40400EVM-351 Circuit Schematic

5 Test Setup

5.1 Test and Configuration Software

In order to change any of the default configuration parameters on the EVM, it is necessary to obtain the TI Fusion Digital Power Designer software.

5.1.1 Description

Fusion Digital Power Designer is the Graphical User Interface (GUI) used to configure and monitor the Texas Instrument's TPS40400 power controller on this Evaluation Module (EVM). The application uses the PMBus protocol to communicate with the controller over serial bus by way of a TI USB adapter (see [Figure 5-3](#)).

5.1.2 Features

Some of the tasks you can perform with the GUI include:

- Turn on or off the power supply output, either through the hardware control line or the PMBus operation command.
- Monitor real-time data. Items such as input voltage, output voltage, output current, and warnings/faults are continuously monitored and displayed by the GUI.
- Configure common operating characteristics such as V_{OUT} , warning and fault thresholds, and switching frequency.

This software is available for download at this location: http://focus.ti.com/docs/toolsw/folders/print/fusion_digital_power_designer.html

5.2 Test Equipment

5.2.1 Voltage Source

The input voltage source V_{IN} should be a 0-V to 14-V variable DC source capable of supplying 10 A_{DC} . Connect V_{IN} to J1 as shown in [Figure 5-2](#).

5.2.2 Multimeters

- DMM 1: V_{IN} at TP1 (V_{IN}) and TP3 (GND).
- DMM 2: Input current measured across Shunt 1.
- DMM 3: V_{OUT} at TP5 (V_{OUT}) and TP17 (GND).
- DMM 4: Output current measured across Shunt 2.

5.2.3 Output Load

The output load should be an electronic constant-resistance mode load capable of 0 A_{DC} to 25 A_{DC} at 1.2 V. An electronic constant-current load is also acceptable.

5.2.4 Oscilloscope

A digital or analog oscilloscope can be used to measure the output ripple. To measure output ripple, the oscilloscope should be set for 1-M Ω impedance, 20-MHz bandwidth, AC coupling, 2- μ s/division horizontal resolution, 50-mV/division vertical resolution. As shown below in [Figure 5-1](#), test points TP5 and TP17 can be used to measure the output ripple voltage by placing the oscilloscope probe tip through TP5 and holding the ground barrel to TP17. It is not recommended to use a leaded ground connection because this may induce additional noise due to the large ground loop.

To measure other waveforms, adjust the oscilloscope as needed.

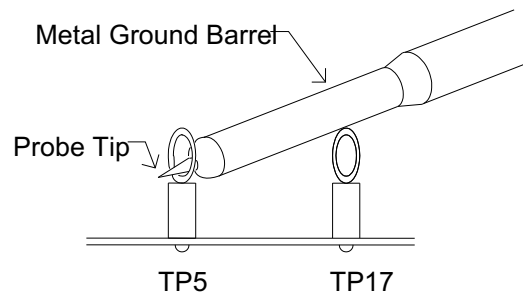

Figure 5-1. Tip and Barrel Measurement for V_{OUT} Ripple

5.2.5 Fan

Some of the components in this EVM may exceed temperatures of 60°C during operation. A small fan capable of 200 LFM to 400 LFM is recommended to reduce component temperatures while the EVM is operating at heavy loads. Exercise caution when touching the EVM while the fan is not running, and always exercise caution when touching any circuits that may be live or energized.

5.2.6 Recommended Wire Gauge

Input Wires, VIN to J1 (12-V input): The minimum recommended wire size is 1x AWG #14 per input connection, with the total length of wire less than 4 feet (2 feet input, 2 feet return). Maximum input current should be in the order of 3.5 A.

Output Wires, J3 and J4 to Load: The minimum recommended wire size is 2x AWG #14, with the total length of wire less than 4 feet (2 feet output, 2 feet return). Maximum output current should be in the order of 20 A.

5.3 Recommended Test Setup

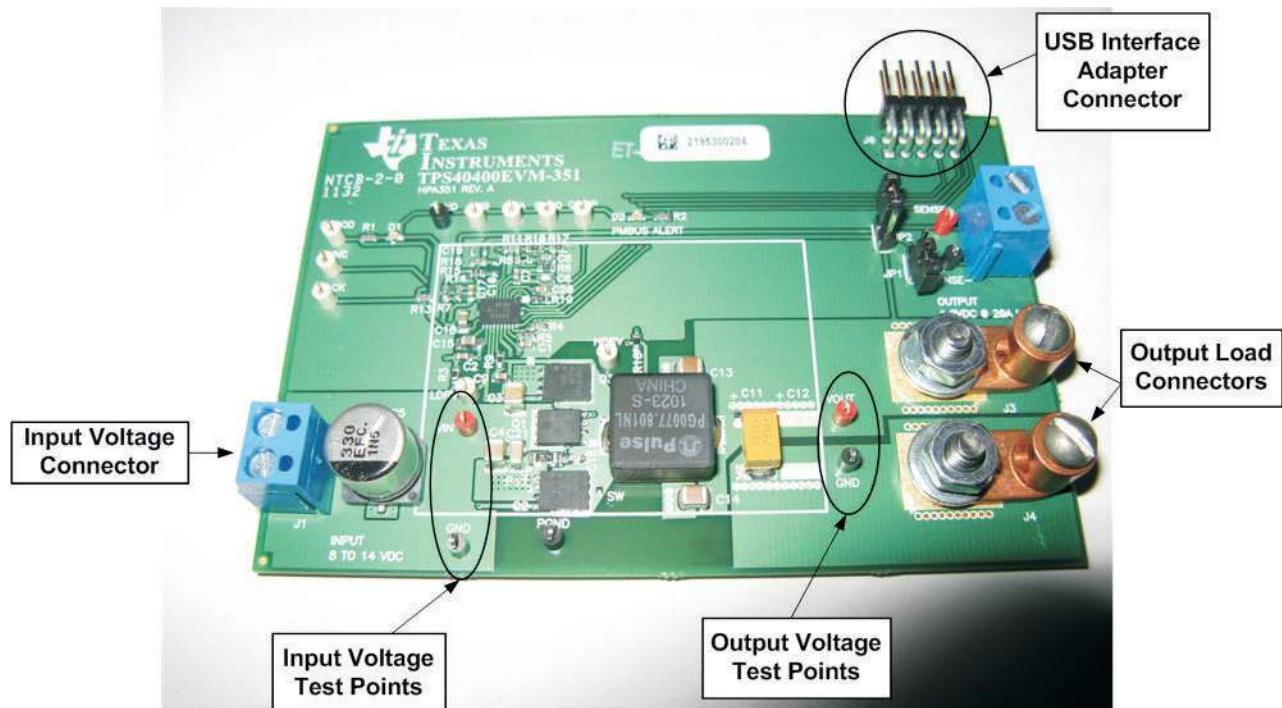

Figure 5-2. TPS40400EVM-351 Recommended Test Set Up

Figure 5-2 is the recommended test set up to evaluate the TPS40400EVM-351. It is recommended to work at an ESD-safe workstation while testing the EVM.

5.4 USB Interface Adapter and Cable

Proper connection and polarity for USB interface adapter and cable.

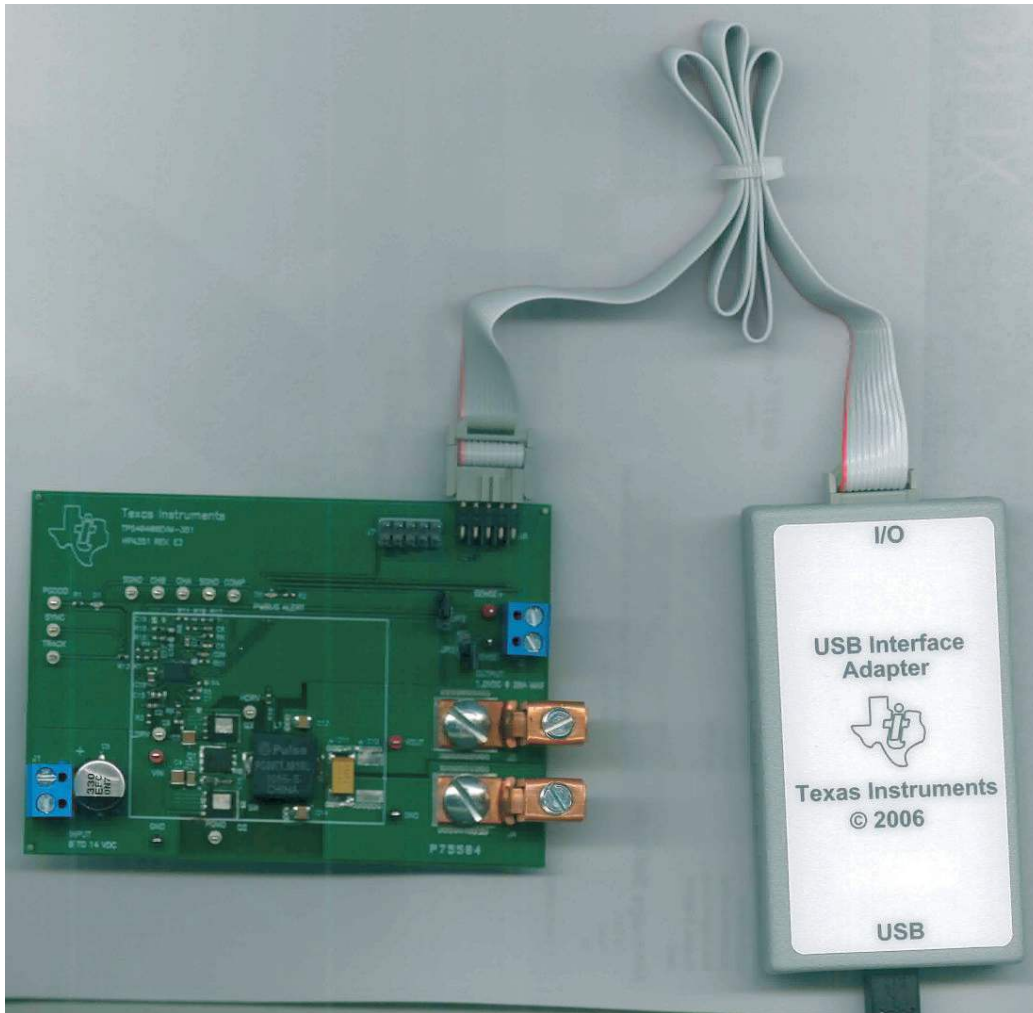

Figure 5-3. TPS40400EVM-351 USB-To-GPIO Interface Adapter

5.4.1 Input Connections

1. Prior to connecting the DC input source V_{IN} , it is advisable to limit the source current from V_{IN} to 10 A maximum. Make sure V_{IN} is initially set to 0 V and connected as shown in [Figure 5-2](#).
2. Connect a voltmeter DMM 1 at TP1 (V_{IN}) and TP3 (GND) to measure the input voltage.
3. Connect a voltmeter DMM 2 across shunt to measure the input current.

5.4.2 Output Connections

1. Connect Load between J3 and J4; and set Load to constant-resistance mode to sink 0 A_{DC} before V_{IN} is applied.
2. Connect a voltmeter DMM 3 at TP5 (V_{OUT}) and TP17 (GND) to measure the output voltage.
3. Connect a voltmeter DMM 4 across shunt to measure the output current.

5.4.3 Jumper Connections, JP1 and JP2

For most tests it is recommended to install both jumpers, JP1 and JP2 on their respective headers. This will result in the remote sense points (the nodes at which the converter will regulate the output voltage) be located near the output connectors J3 and J4. This configuration is best for most functional testing.

These jumpers can be arranged differently depending on the desired location of remote sense.

Note

The amount of voltage drop between the output connectors J3 and J4 and the remote sense points is limited by the power dissipation in the internal remote sense resistors R7 and R18 (see schematic, [Figure 4-1](#)).

These resistors are rated for 0.0625 W and are 49.9 Ω . This implies a remote sense voltage drop of no more than 1.7 V in each of the +VE and –VE sense lines. Since this EVM is configured as a 1.2-V output, this will likely not be the limiting factor, but caution is still advised because when remote sense is being utilized, the EVM will attempt to regulate out a lossy load wire installation.

Note

The EVM may detect an Over-Voltage (OV) condition when remote sensing is being used, depending on the configurable OV setting. Refer to [Section 5.2.6](#) for wire gauge recommendations.

When remote sense is not being utilized and the sense points are defaulted to the output connector of the EVM, the voltage drop in the load wires and the resulting reduced voltage applied to the electronic load may cause erratic behavior with the electronic load. This is because many loads will not function properly at input voltages lower than 1 V, which implies no more than 0.2-V drop combined in the load wires (+ and – load wires). Consult the documentation of the electronic load being used.

5.4.4 Jumper Configurations

All Jumper selections should be made prior to applying power to the EVM. User can configure this EVM as per following configurations.

Table 5-1. Jumper Configurations

JUMPERS JP1 AND JP2	DISCRETE SENSE WIRES	RESULT	USED FOR
Installed	Do not use	Default. Sense points are at the output connectors of the EVM.	Most testing.
Not installed	Not installed	Sense points are at the output connectors of the EVM, but through R7 and R18. Regulation will be degraded.	Not usually desired in this configuration.
Not installed	Installed and connected to the output voltage at the location where regulation is desired	Regulation will be at the far end location of the added discrete sense wires, usually desired to be the point of load.	Tight regulation of output voltage at a remote location, subject to the limitations mentioned in 5.4.3.

6 EVM Configuration Using the Fusion GUI

In order to configure the TPS40400 controller on the EVM, it is required to use the TI Fusion Digital Power Designer software. It is necessary to have input voltage applied to the EVM prior to launching the software so that the TPS40400 may respond to the GUI and the GUI can recognize the TPS40400. The default configuration for the EVM is to start converting at an input voltage of 7 V, so in order to avoid any converter activity during initial configuration, an input voltage less than 7 V should be applied.

6.1 Configuration Procedure

1. Adjust the input supply to provide 5 V_{DC}, current limited to 1 A.
2. Apply the input voltage to the EVM. Refer to Figure 3: and Figure 4: for connections and test setup.
3. Launch the Fusion GUI software. Refer to the following screenshots in section 6.2 for more information.
4. Configure the EVM operating parameters as needed.

CAUTION

Some parameters can be configured to values that can result in erratic or unexpected behavior on this EVM. Consult the TPS40400 datasheet for guidance in configuration of parameters.

6.2 Fusion GUI Screenshots

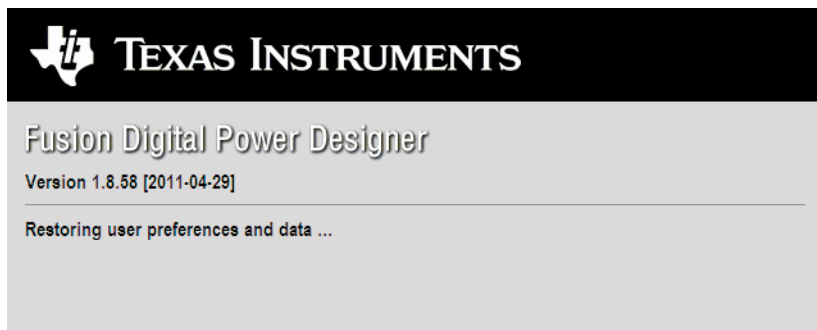

Figure 6-1. Screenshot 1: First Screen Upon Launching Fusion Software (Version may not match)

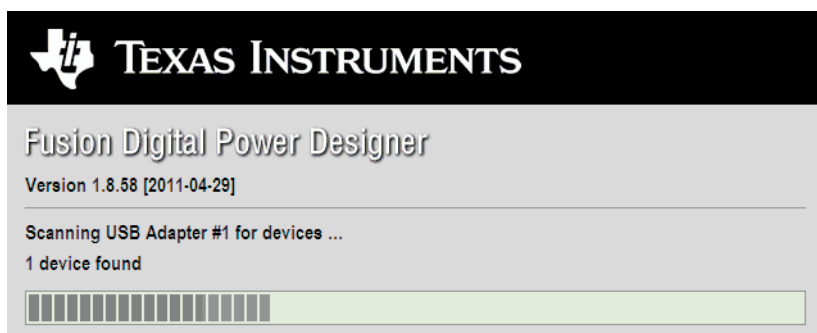

Figure 6-2. Screenshot 2: Fusion Successfully Recognizes the Device on EVM

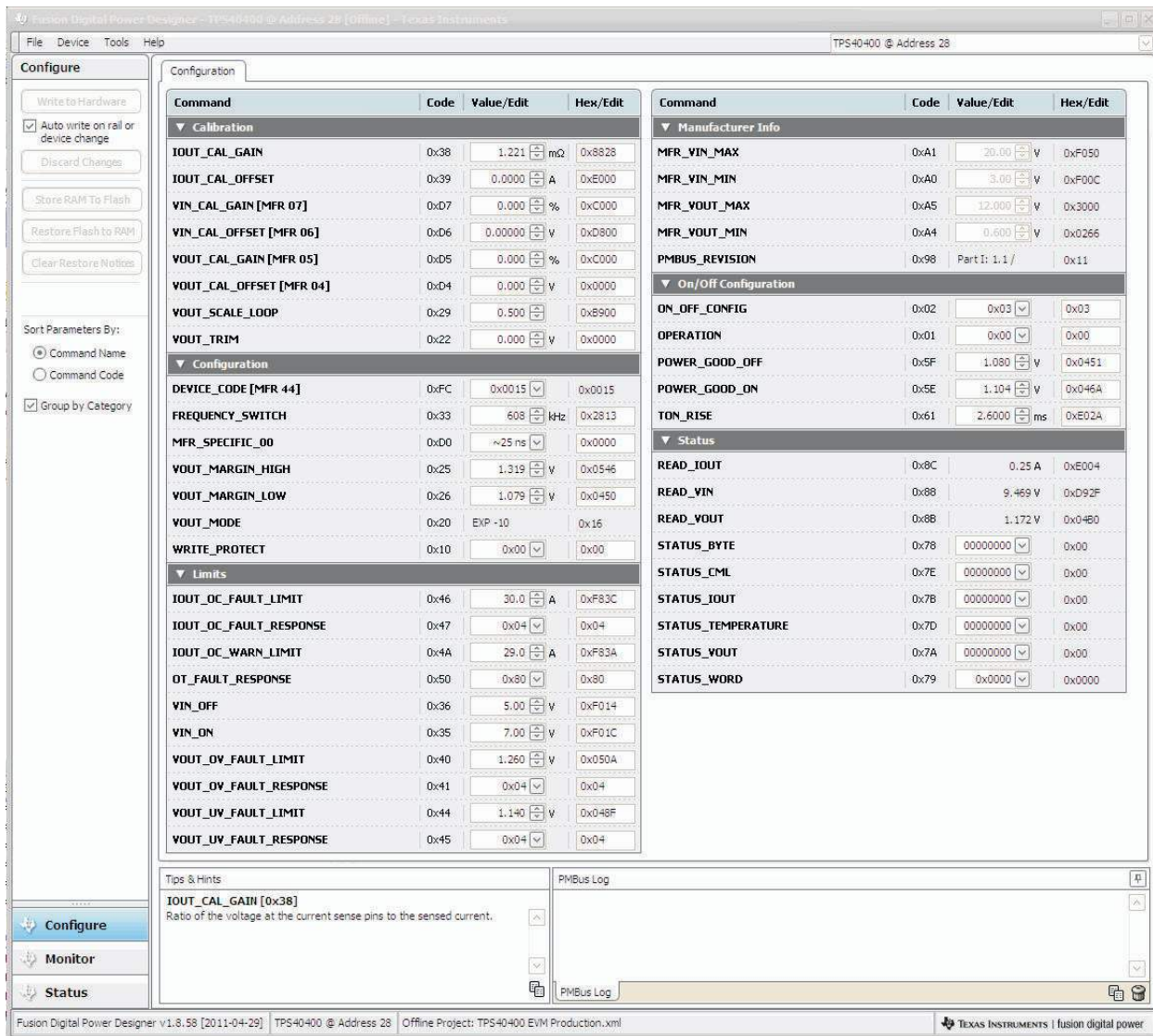

Figure 6-3. Screenshot 3: First Functional Screen, Configure Screen

Note

Most of these parameters are configurable. Consult the datasheet for the TPS40400 for details on how to configure the device to achieve the desired performance.

CAUTION

Some parameters can be configured to values that can result in erratic or unexpected behavior on this EVM. Consult the TPS40400 datasheet for guidance in configuration of parameters.

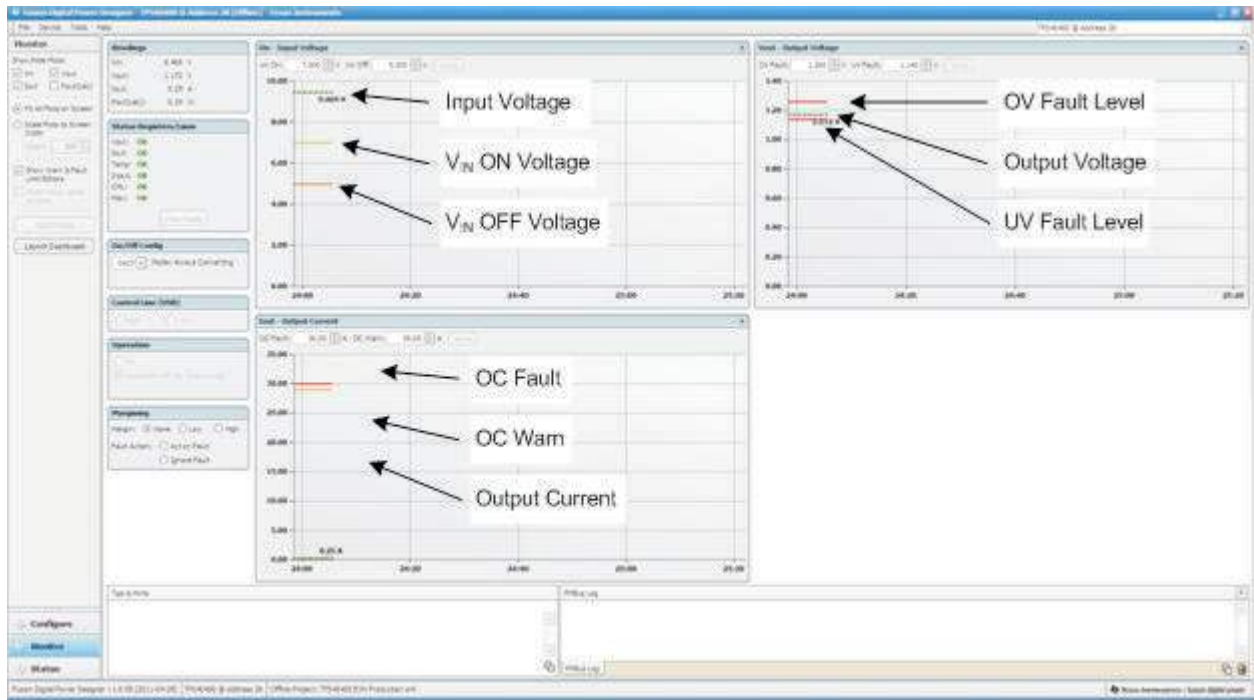

Figure 6-4. Screenshot 4: "Monitor" Screen

7 Test Procedure

7.1 Line/Load Regulation and Efficiency Measurement Procedure

1. Set up EVM as described in [Section 5.3](#) and [Figure 5-2](#).
2. Ensure load is set to draw 0 A_{DC}.
3. Ensure all jumper configuration settings per [Section 5.4.4](#).
4. Increase V_{IN} from 0 V to 12 V. Using DMM 1 to measure input voltage.
5. Use DMM 3 to measure output voltage V_{OUT}.
6. Vary Load from 0 A_{DC} to 20 A_{DC}, V_{OUT} should be remain in load regulation.
7. Vary V_{IN} from 8 V to 14 V, V_{OUT} should remain in line regulation.
8. Decrease Load to 0 A
9. Decrease V_{IN} to 0 V.

7.2 Control Loop Gain and Phase Measurement Procedure

TPS40400EVM-351 contains a 49.9-Ω series resistor in the feedback loop for loop response analysis.

1. Set up EVM as described in [Section 5.3](#) and [Figure 5-2](#).
2. Connect isolation transformer to test points marked TP13 and TP15.
3. Connect input signal amplitude measurement probe (channel A) to TP13. Connect output signal amplitude measurement probe (channel B) to TP15.
4. Connect ground lead of channel A and channel B to TP14 and TP16.
5. Inject 40-mV or less signal through the isolation transformer.
6. Sweep the frequency from 100 Hz to 1 MHz with 10-Hz or lower post filter. The control loop gain and phase margin can be measured.
7. Disconnect isolation transformer from bode plot test points before making other measurements (Signal injection into feedback may interfere with accuracy of other measurements).

7.3 List of Test Points

Table 7-1. TPS40400EVM-351 Test Point Functions

TEST POINTS	NAME	DESCRIPTION
TP1	V _{IN}	Input voltage
TP2	COMP	Output of error amplifier
TP3	GND	Ground
TP4	PGOOD	Power good
TP5	VOUT	Output voltage
TP6	SENSE +	Positive remote sense
TP7	HDRV	High-side driver output
TP8	SYNC	Input, to synchronize oscillator to external frequency
TP9	TRACK	Input to non-inverting side of error amplifier
TP10	SW	Switch node
TP11	LDRV	Low side driver output
TP12	PGND	Power ground
TP13	CHA	Input A for loop injection
TP14	SGND	Signal ground
TP15	CHB	Input B for loop injection
TP16	SGND	Signal ground
TP17	GND	Ground
TP18	SENSE -	Negative remote sense

7.4 Equipment Shutdown

1. Reduce load current to zero amperes.
2. Reduce input voltage to zero volts.
3. Shut down FAN.

8 Performance Data and Typical Characteristic Curves

Figure 8-1 through Figure 8-12 represent typical performance curves for TPS40400EVM-351.

8.1 Efficiency

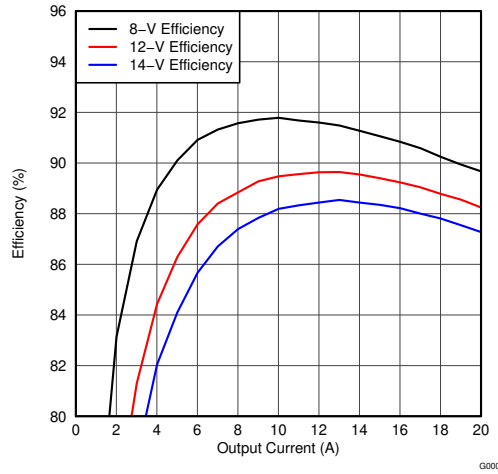

Figure 8-1.

8.2 Load Regulation

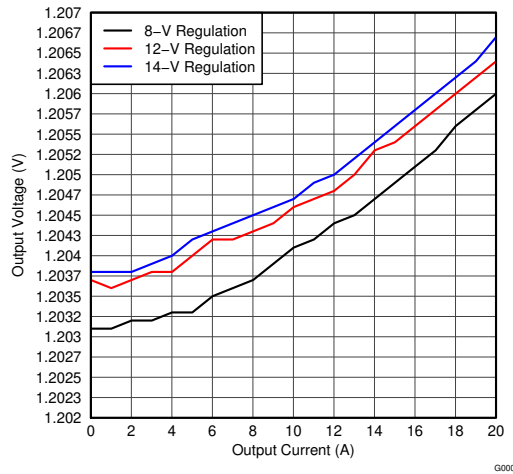

Figure 8-2.

8.3 Load Transients 1

Table 8-1. Load Transients 1

V _{IN}	TRANSIENT	TIMEBASE	CH2	CH4
8 V	5 A - 11 A - 5 A	100 μs	V _{OUT}	I _{OUT} 5 A/div.

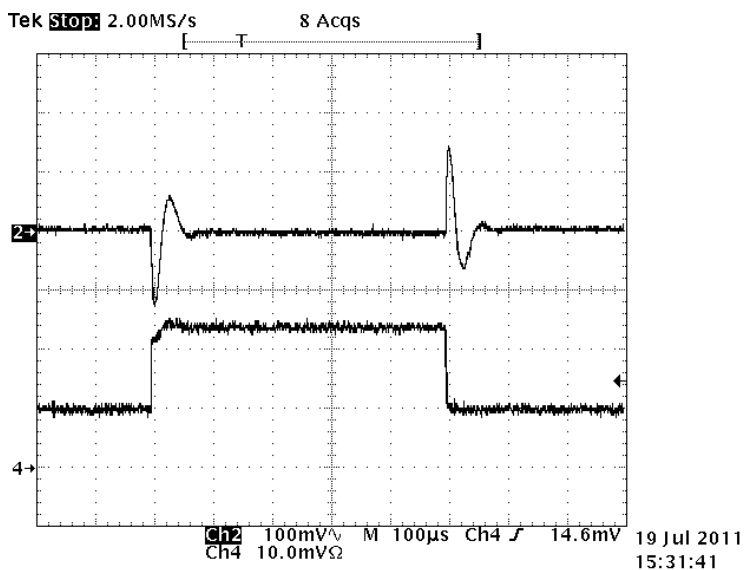

Figure 8-3.

8.4 Load Transient 2

Table 8-2. Load Transients 2

V _{IN}	TRANSIENT	TIMEBASE	CH2	CH4
8 V	5 A - 11 A	10 μs	V _{OUT}	I _{OUT} 5 A/div.

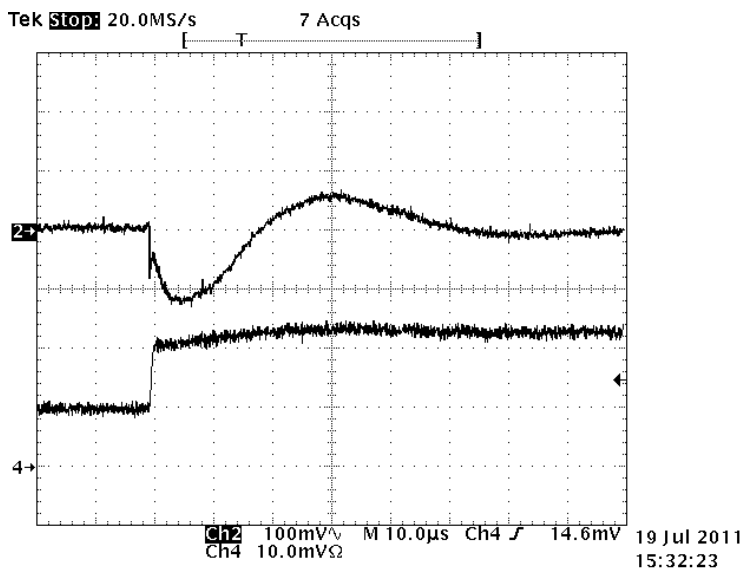

Figure 8-4.

8.5 Load Transient 3

Table 8-3. Load Transients 3

V _{IN}	TRANSIENT	TIMEBASE	CH2	CH4
8 V	11 A -5 A	10 μ s	V _{OUT}	I _{OUT} 5 A/div.

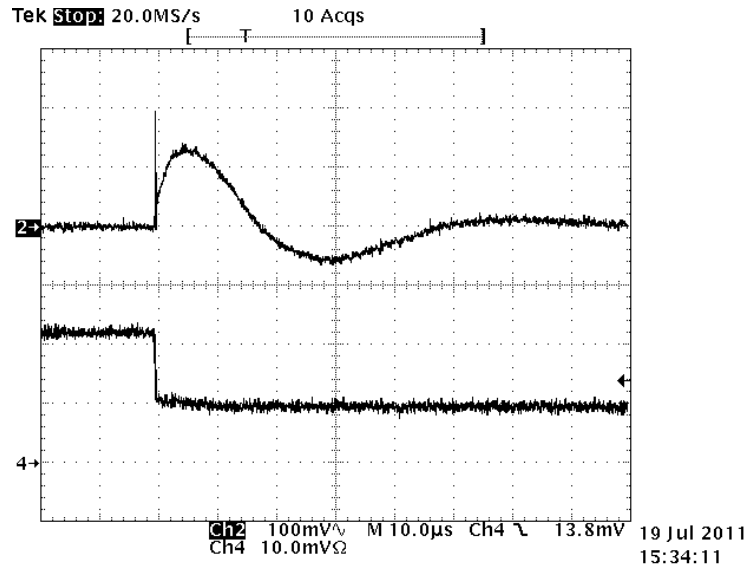

Figure 8-5.

8.6 Input and Output Ripple

Table 8-4. Input and Output Ripple

V _{IN}	TRANSIENT	TIMEBASE	CH1	CH2
14 V	20 A	400 ns	V _{IN}	V _{OUT}

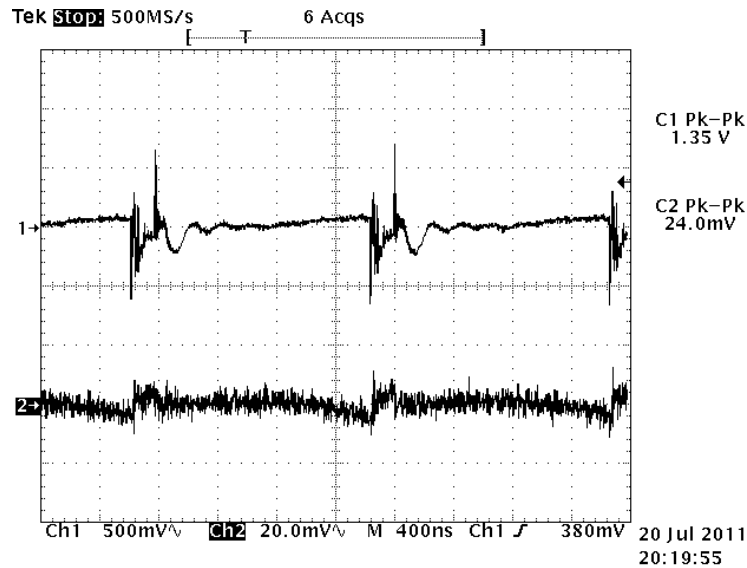

Figure 8-6.

8.7 Switch Node and HDRV

Table 8-5. Switch Node and HDRV

V _{IN}	TRANSIENT	TIMEBASE	CH1	CH2
8 V	20 A	40 ns	HDRV	SW

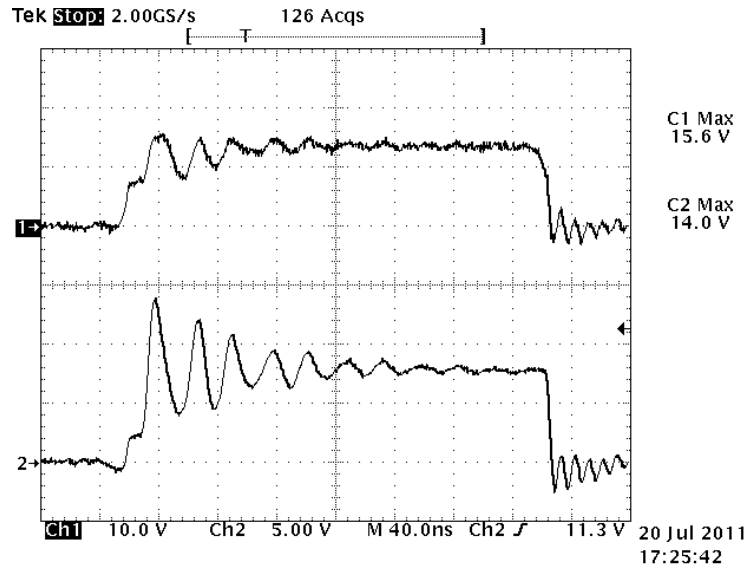

Figure 8-7.

8.8 V_{IN} Turn On

Table 8-6. V_{IN} Turn On

V _{IN}	TRANSIENT	TIMEBASE	EVENT	CH1	CH2
8 V	10 A	1 ms	V _{IN} ON	V _{IN}	V _{OUT}

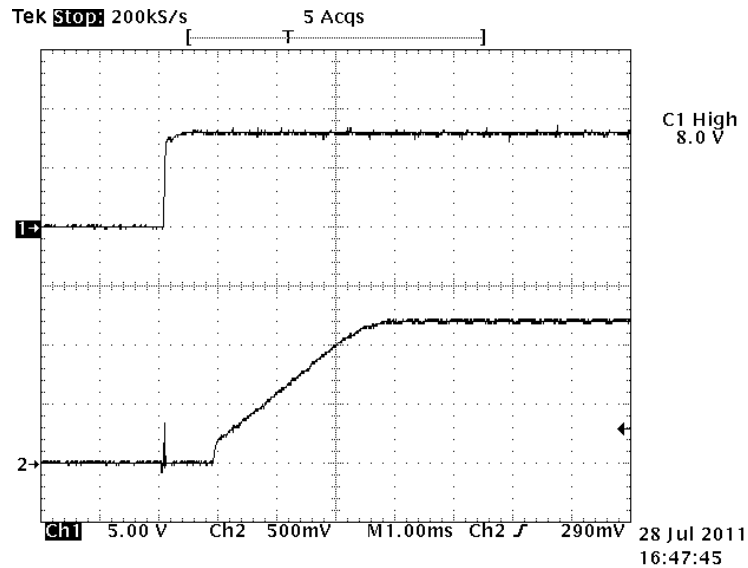

Figure 8-8.

8.9 Enable ON / OFF

Table 8-7. Enable ON/OFF 1

V _{IN}	I _{OUT}	TIMEBASE	EVENT	CH1	CH2	CH3
8 V	10 A	400 μs	CNTRL ON	V _{OUT}	CNTRL	V _{IN}

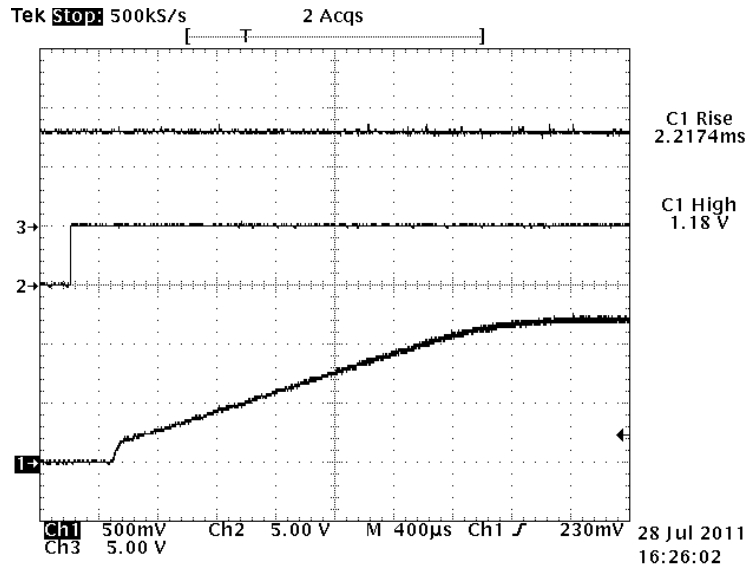

Figure 8-9.

Table 8-8. Enable ON/OFF 2

V _{IN}	I _{OUT}	TIMEBASE	EVENT	CH1	CH2	CH3
8 V	10 A	20 μs	CNTRL OFF	CNTRL	V _{IN}	V _{OUT}

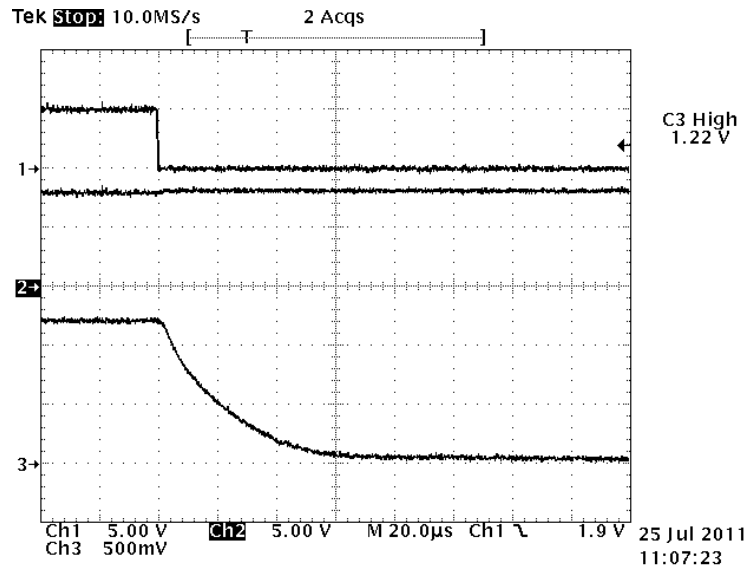

Figure 8-10.

8.10 Turn ON with 92% (1.1V) Pre-bias

Table 8-9. Turn ON with 92% (1.1 V) Pre-Bias

V _{IN}	I _{OUT}	TIMEBASE	EVENT	CH1	CH2	CH3	PREBIAS VOLTAGE
14 V	0 A	1 ms	PreBias Turn ON	CNTRL	V _{IN}	V _{OUT}	1.1 V

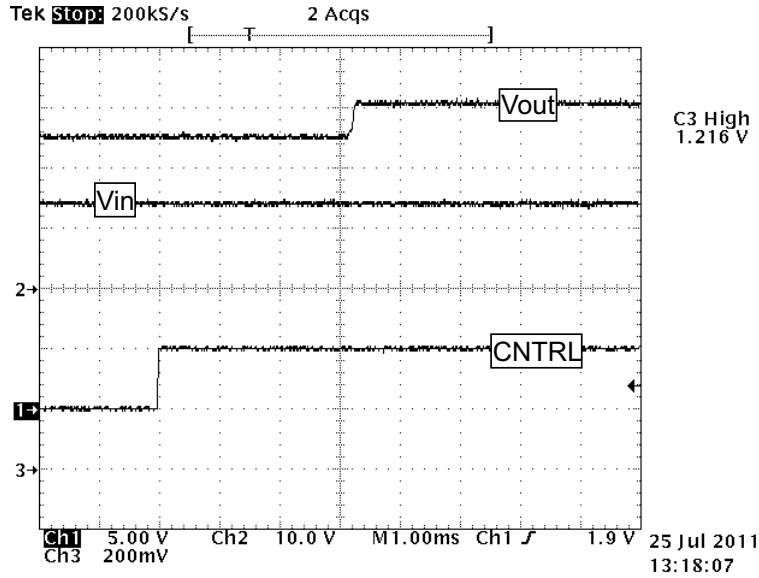

Figure 8-11.

8.11 TPS40400EVM-351 Bode Plot (20-A output)

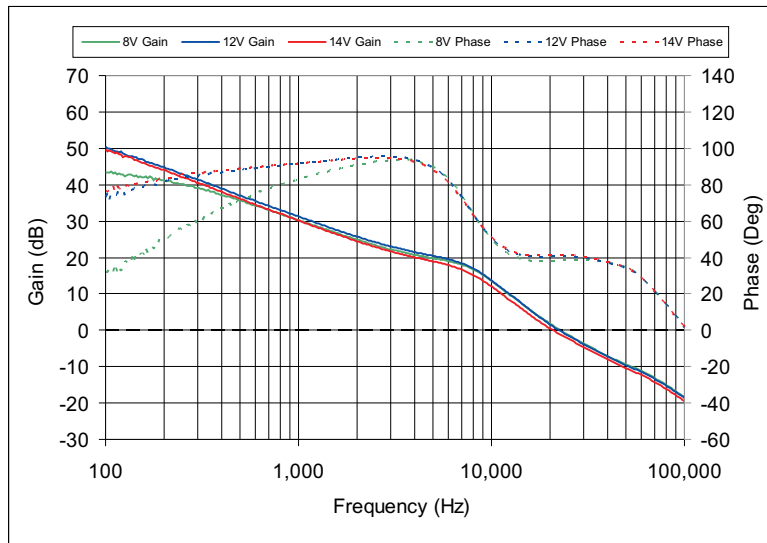

Figure 8-12.

9 EVM Assembly Drawing and PCB Layout

The following figures (Figure 9-1 through Figure 9-4) show the design of the TPS40400EVM-351 printed circuit board. The EVM has been designed using 2 Layers, 2-oz copper circuit board.

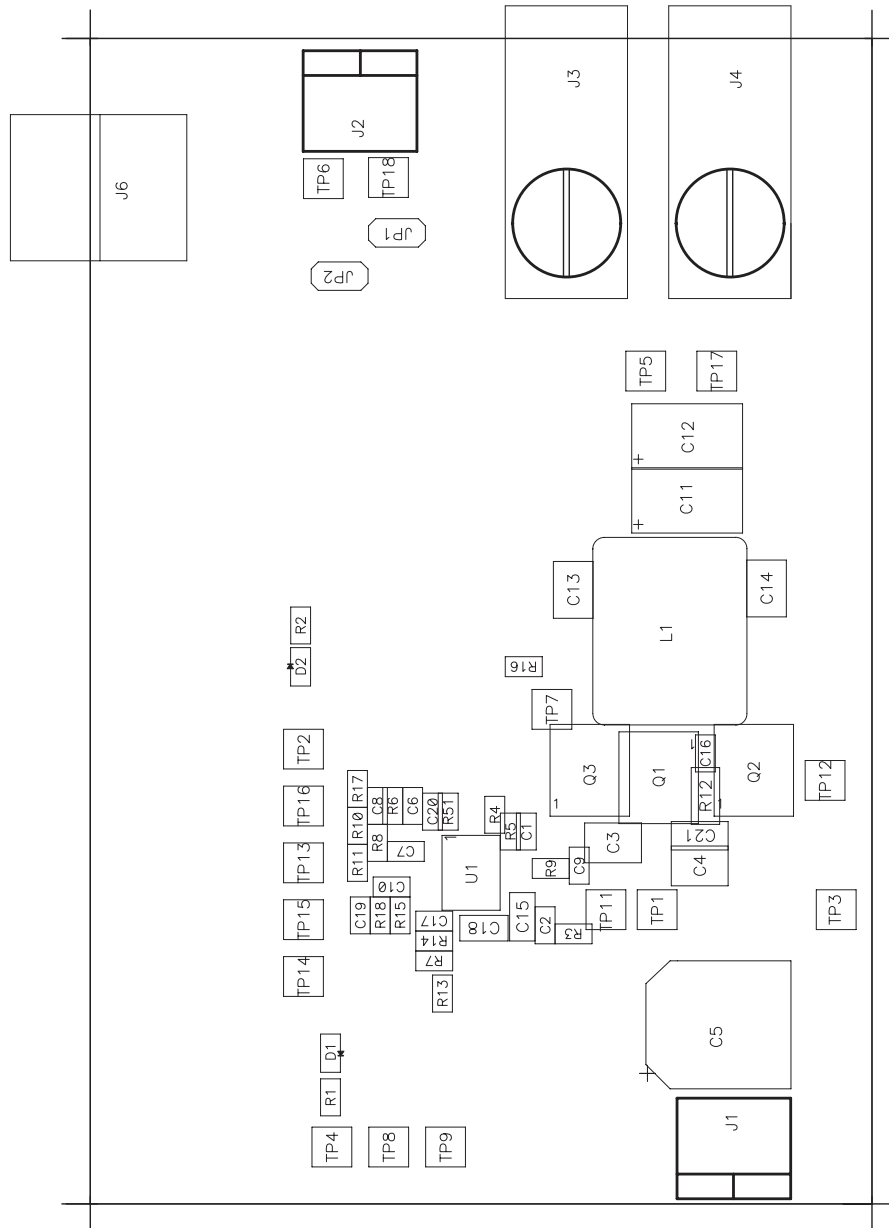

Figure 9-1. Top Assembly

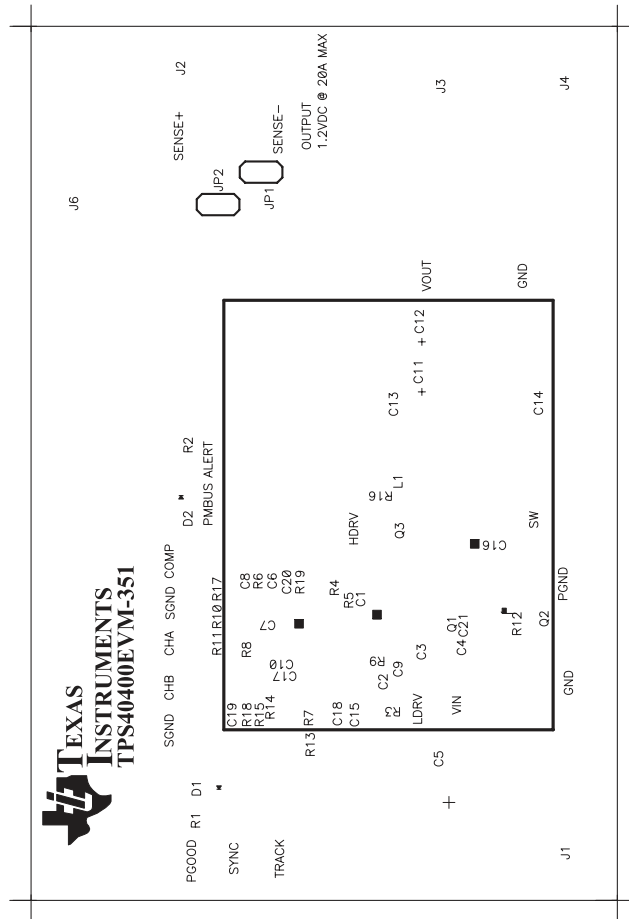

Figure 9-2. Top Copper

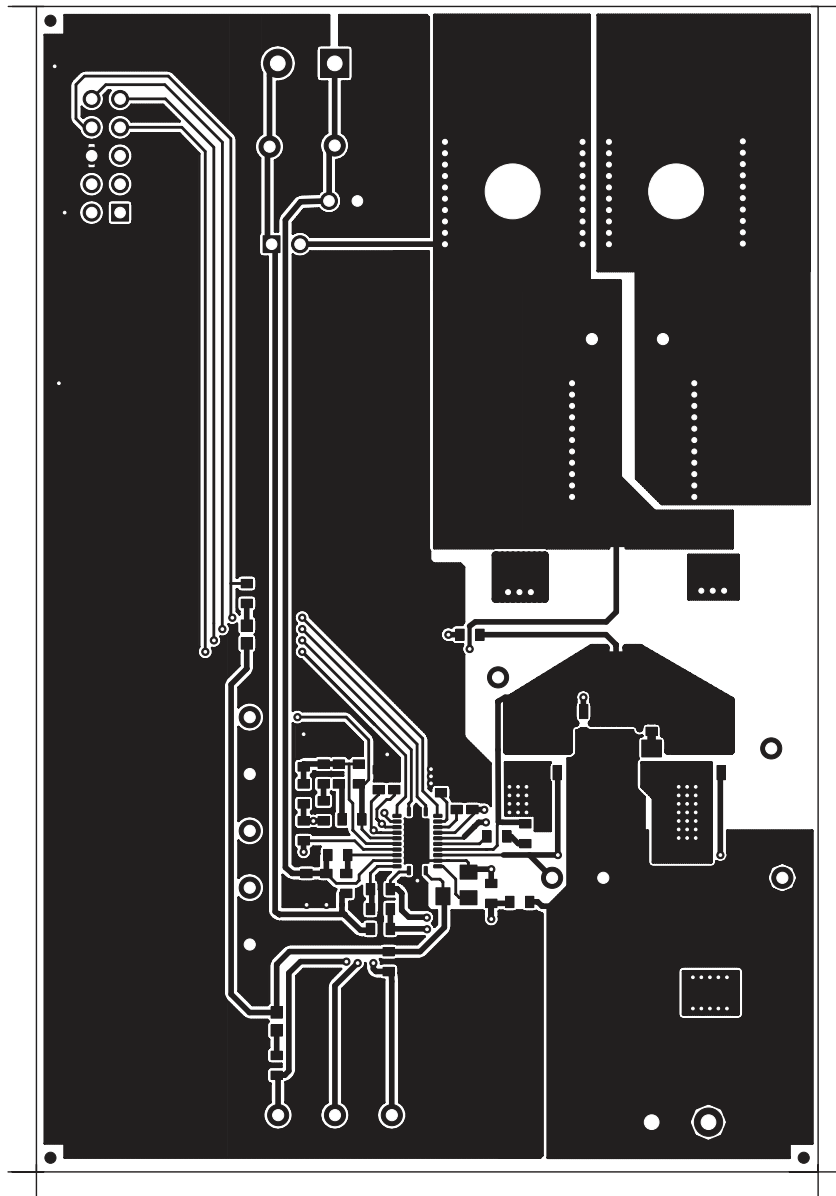

Figure 9-3. Bottom Copper

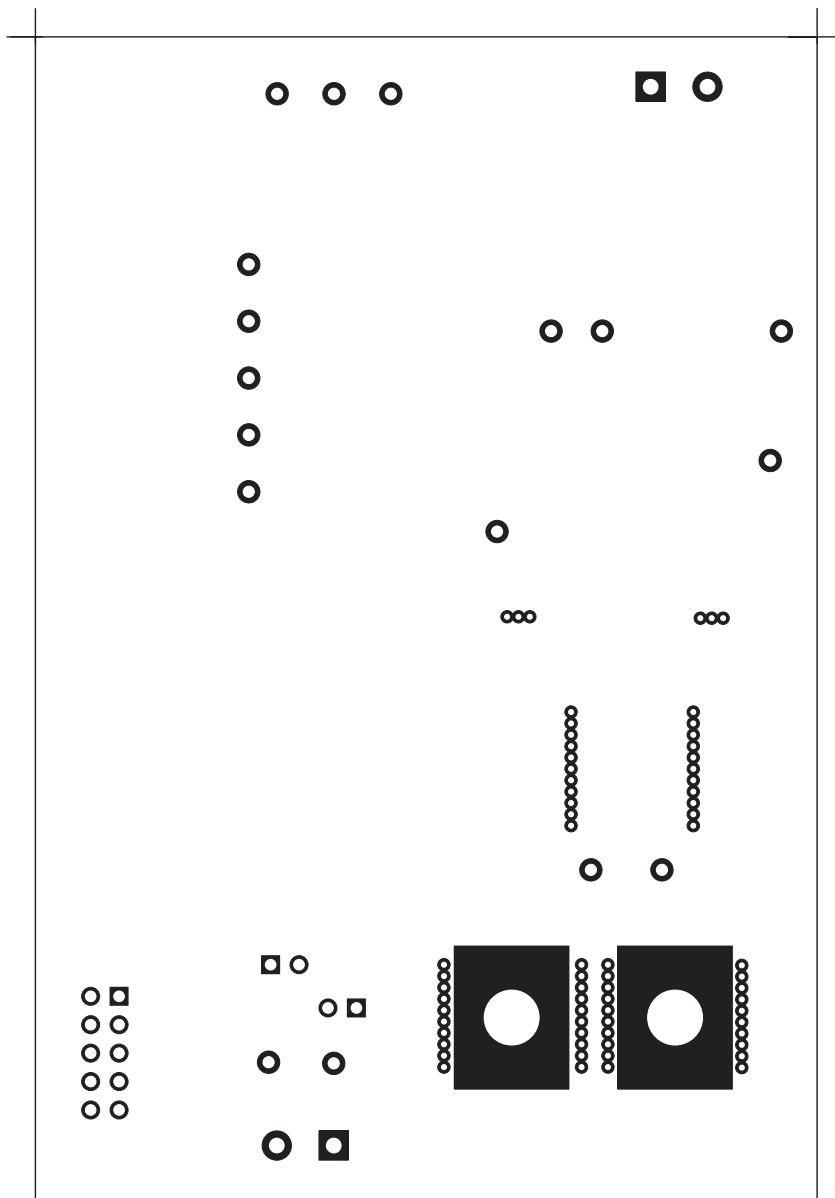

Figure 9-4. Top Silk

10 List of Materials

The EVM components list according to the schematic shown in [Figure 4-1](#).

Table 10-1. TPS40400EVM-351 List of Materials

QTY	REF DES	DESCRIPTION	PART NUMBER	MFR
4	C1, C2, C9, C17	Capacitor, ceramic, 25 V, X7R, 10%, 100 nF, 0603	std	std
0	C10	Capacitor, ceramic, open, 0603		
1	C11	Capacitor, tantalum, 6.3 V, 10%, 680 μ F, 7343 (D)	TPSE687K006R0045	AVX
0	C12	Capacitor, tantalum, open, 7343 (D)		
2	C13, C14	Capacitor, ceramic, 6.3 V, X7R, 10%, 47 μ F, 1210	std	std
2	C15, C18	Capacitor, ceramic, 16 V, X7R, 10%, 1 μ F, 0805	std	std
1	C16	Capacitor, ceramic, 25 V, X7R, 10%, 1.0 nF, 0603	std	std
0	C19	Capacitor, ceramic, open, 0603		
1	C20	Capacitor, ceramic, 50 V, X7R, 10%, 10 nF, 0603	std	std
1	C21	Capacitor, ceramic, 25 V, X7R, 10%, 1.0 μ F, 1206	std	std
2	C3, C4	Capacitor, ceramic, 25 V, X7R, 10%, 22 μ F, 1210	std	std
1	C5	Capacitor, aluminum, SM, 330 μ F, 25 V, 150 m Ω , FC series, 10 mm x 12 mm	EEVFC1E331P	Panasonic
1	C6	Capacitor, ceramic, 50 V, X7R, 10%, 680 pF, 0603	std	std
1	C7	Capacitor, ceramic, 50 V, X7R, 10%, 2.2 nF, 0603	std	std
1	C8	Capacitor, ceramic, 50 V, X7R, 10%, 820 pF, 0603	std	std
2	D1, D2	Diode, LED, red, 2.1 V, 20 mA, 6 mcd, 0603	LTST-C190CKT	Lite On
2	J1, J2	Terminal block, 2 pin, 15 A, 5.1 mm, D120/2DS, 0.40 inch x 0.35 inch	ED120/2DS	On Shore Technology
2	J3, J4	Type L - copper single conductor, one-hole mount, L35, 0.813 inch x 0.375 inch	L35	Thomas and Betts
1	J6	Connector, male right angle 2 x 5 pin, 100-mil spacing, 4 wall, 0.607 inch x 0.484 inch	86479-3	AMP
2	JP1, JP2	Header, 2 pin, 100-mil spacing, 0.100 inch x 2 inch	PTC36SAAN	Sullins
1	L1	Inductor, SMT, 0.75 μ H, 1.2 m Ω , 31 A, 0.512 inch x 0.571 inch	PG0077.801	Pulse
1	Q1	MOSFET, N-Channel, 25 V, 20 A, 4.1 m Ω , QFN 5 x 6 mm	CSD16404Q5A	TI
2	Q2, Q3	MOSFET, N-Channel, 25 V, 33 A, 1.7 m Ω , QFN-8 POWER	CSD16325Q5	TI

Table 10-1. TPS40400EVM-351 List of Materials (continued)

QTY	REF DES	DESCRIPTION	PART NUMBER	MFR
2	R1, R2	Resistor, chip, 1/16 W, 5%, 1 kΩ, 0603	std	std
3	R10, R17, R19	Resistor, chip, 1/16 W, 1%, 10 kΩ, 0603	std	std
1	R12	Resistor, chip, 1/8 W, 1%, 2.74 Ω, 1206	std	std
1	R13	Resistor, chip, 1/16 W, 1%, 100 kΩ, 0603	std	std
1	R14	Resistor, chip, 1/16 W, 1%, 200 Ω, 0603	std	std
1	R15	Resistor, chip, 1/16 W, 1%, 0 Ω, 0603	std	std
1	R16	Resistor, chip, 1/16 W, 1%, 6.19 kΩ, 0603	std	std
2	R3, R9	Resistor, chip, 1/16 W, 1%, 10 Ω, 0603	std	std
1	R4	Resistor, chip, 1/16 W, 1%, 36.5 kΩ, 0603	std	std
1	R5	Resistor, chip, 1/16 W, 1%, 54.9 kΩ, 0603	std	std
1	R6	Resistor, chip, 1/16 W, 1%, 4.99 kΩ, 0603	std	std
3	R7, R11, R18	Resistor, chip, 1/16 W, 1%, 49.9 Ω, 0603	std	std
1	R8	Resistor, chip, 1/16 W, 1%, 2.74 kΩ, 0603	std	std
1	U1	3.0-V to 20-V PMBus Synchronous Buck Controller, QFN-24	TPS40400RHL	TI
1	--	PCB, 4.1 inch x 2.75 inch x 0.062 inch	HPA351	Any

11 Revision History

NOTE: Page numbers for previous revisions may differ from page numbers in the current version.

Changes from Revision * (September 2011) to Revision A (January 2022)	Page
• Updated the numbering format for tables, figures, and cross-references throughout the document.	2
• Updated the user's guide title	2

IMPORTANT NOTICE AND DISCLAIMER

TI PROVIDES TECHNICAL AND RELIABILITY DATA (INCLUDING DATA SHEETS), DESIGN RESOURCES (INCLUDING REFERENCE DESIGNS), APPLICATION OR OTHER DESIGN ADVICE, WEB TOOLS, SAFETY INFORMATION, AND OTHER RESOURCES "AS IS" AND WITH ALL FAULTS, AND DISCLAIMS ALL WARRANTIES, EXPRESS AND IMPLIED, INCLUDING WITHOUT LIMITATION ANY IMPLIED WARRANTIES OF MERCHANTABILITY, FITNESS FOR A PARTICULAR PURPOSE OR NON-INFRINGEMENT OF THIRD PARTY INTELLECTUAL PROPERTY RIGHTS.

These resources are intended for skilled developers designing with TI products. You are solely responsible for (1) selecting the appropriate TI products for your application, (2) designing, validating and testing your application, and (3) ensuring your application meets applicable standards, and any other safety, security, regulatory or other requirements.

These resources are subject to change without notice. TI grants you permission to use these resources only for development of an application that uses the TI products described in the resource. Other reproduction and display of these resources is prohibited. No license is granted to any other TI intellectual property right or to any third party intellectual property right. TI disclaims responsibility for, and you will fully indemnify TI and its representatives against, any claims, damages, costs, losses, and liabilities arising out of your use of these resources.

TI's products are provided subject to [TI's Terms of Sale](#) or other applicable terms available either on ti.com or provided in conjunction with such TI products. TI's provision of these resources does not expand or otherwise alter TI's applicable warranties or warranty disclaimers for TI products.

TI objects to and rejects any additional or different terms you may have proposed.

Mailing Address: Texas Instruments, Post Office Box 655303, Dallas, Texas 75265
Copyright © 2022, Texas Instruments Incorporated