

### 3 V, SUPER MINIMOLD SILICON MMIC MEDIUM OUTPUT POWER AMPLIFIER FOR MOBILE COMMUNICATIONS

#### DESCRIPTION

The  $\mu$ PC2762TB,  $\mu$ PC2763TB and  $\mu$ PC2771TB are silicon monolithic integrated circuits designed as amplifier for mobile communications. These ICs operate at 3 V. The medium output power is suitable for RF-TX of mobile communications system.

These IC is manufactured using NEC's 20 GHz fr NESAT™III silicon bipolar process. This process uses direct silicon nitride passivation film and gold electrodes. These materials can protect the chip surface from pollution and prevent corrosion/migration. Thus, this IC has excellent performance, uniformity and reliability.

#### FEATURES

- Supply voltage :  $V_{CC} = 2.7$  to  $3.3$  V
- Medium output power :  $\mu$ PC2762TB;  $P_{O(1\text{ dB})} = +8.0$  dBm TYP. @  $f = 0.9$  GHz  
 $\mu$ PC2763TB;  $P_{O(1\text{ dB})} = +9.5$  dBm TYP. @  $f = 0.9$  GHz  
 $\mu$ PC2771TB;  $P_{O(1\text{ dB})} = +11.5$  dBm TYP. @  $f = 0.9$  GHz
- Power gain :  $\mu$ PC2762TB;  $G_P = 13$  dB TYP. @  $f = 0.9$  GHz  
 $\mu$ PC2763TB;  $G_P = 20$  dB TYP. @  $f = 0.9$  GHz  
 $\mu$ PC2771TB;  $G_P = 21$  dB TYP. @  $f = 0.9$  GHz
- ★ Upper limit operating frequency :  $\mu$ PC2762TB;  $f_u = 2.9$  GHz TYP. @ 3dB Bandwidth  
 $\mu$ PC2763TB;  $f_u = 2.7$  GHz TYP. @ 3dB Bandwidth  
 $\mu$ PC2771TB;  $f_u = 2.2$  GHz TYP. @ 3dB Bandwidth
- High-density surface mounting : 6-pin super minimold package ( $2.0 \times 1.25 \times 0.9$  mm)

#### APPLICATIONS

- Buffer amplifiers for mobile telephones:  $\mu$ PC2762TB,  $\mu$ PC2763TB
- PA driver for PDC800M :  $\mu$ PC2771TB

#### ORDERING INFORMATION

Part Number	Package	Marking	Supplying Form
$\mu$ PC2762TB-E3	6-pin super minimold	C1Z	Embossed tape 8 mm wide. 1, 2, 3 pins face the perforation side of the tape. Qty 3 kpcs/reel.
$\mu$ PC2763TB-E3		C2A	
$\mu$ PC2771TB-E3		C2H	

**Remark** To order evaluation samples, please contact your local NEC sales office.  
Part number for sample order:  $\mu$ PC2762TB,  $\mu$ PB2763TB,  $\mu$ PC2771TB

**Caution Electro-static sensitive devices**

The information in this document is subject to change without notice. Before using this document, please confirm that this is the latest version.  
Not all devices/types available in every country. Please check with local NEC representative for availability and additional information.

**PIN CONNECTIONS**

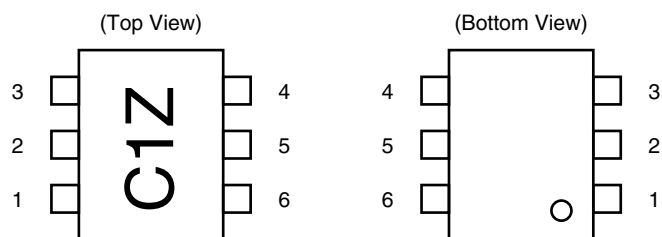

Marking is an example of  $\mu$ PC2762TB

Pin No.	Pin Name
1	INPUT
2	GND
3	GND
4	OUTPUT
5	GND
6	V <sub>CC</sub>

★ **PRODUCT LINE-UP** (T<sub>A</sub> = +25°C, V<sub>CC</sub> = V<sub>out</sub> = 3.0 V, Z<sub>s</sub> = Z<sub>L</sub> = 50 Ω)

Part No.	f <sub>u</sub> (GHz)	P <sub>O(1 dB)</sub> (dBm)	G <sub>p</sub> (dB)	I <sub>CC</sub> (mA)	Package	Marking
$\mu$ PC2762T	2.9	+8.0 @ f = 0.9 GHz	13.0 @ f = 0.9 GHz	26.5	6-pin minimold	C1Z
$\mu$ PC2762TB		+7.0 @ f = 1.9 GHz	15.5 @ f = 1.9 GHz		6-pin super minimold	
$\mu$ PC2763T	2.7	+9.5 @ f = 0.9 GHz	20.0 @ f = 0.9 GHz	27.0	6-pin minimold	C2A
$\mu$ PC2763TB		+6.5 @ f = 1.9 GHz	21.0 @ f = 1.9 GHz		6-pin super minimold	
$\mu$ PC2771T	2.2	+11.5 @ f = 0.9 GHz	21.0 @ f = 0.9 GHz	36.0	6-pin minimold	C2H
$\mu$ PC2771TB		+9.5 @ f = 1.5 GHz	21.0 @ f = 1.5 GHz		6-pin super minimold	
$\mu$ PC8181TB	4.0	+8.0 @ f = 0.9 GHz +7.0 @ f = 1.9 GHz +7.0 @ f = 2.4 GHz	19.0 @ f = 0.9 GHz 21.0 @ f = 1.9 GHz 22.0 @ f = 2.4 GHz	23.0	6-pin super minimold	C3E
$\mu$ PC8182TB	2.9	+9.5 @ f = 0.9 GHz +9.0 @ f = 1.9 GHz +8.0 @ f = 2.4 GHz	21.5 @ f = 0.9 GHz 20.5 @ f = 1.9 GHz 20.5 @ f = 2.4 GHz	30.0	6-pin super minimold	C3F

**Remark** Typical performance. Please refer to ELECTRICAL CHARACTERISTICS in detail.

**Caution** The package size distinguishes between minimold and super minimold.

SYSTEM APPLICATION EXAMPLE

Digital cellular telephone

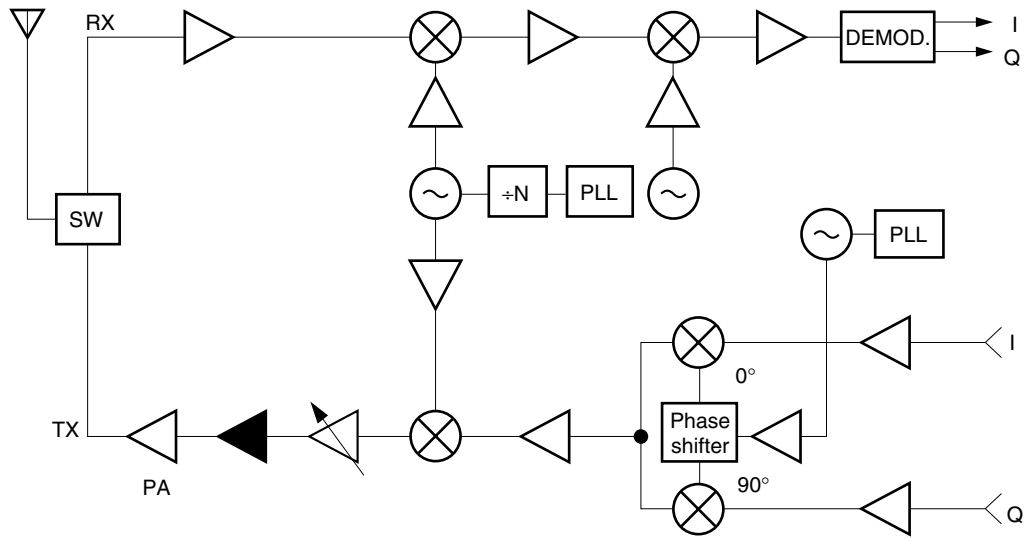

◀:  $\mu$ PC2762TB, 2763TB, 2771TB applicable

**Caution** The insertion point is different due to the specifications of conjunct devices.

**PIN EXPLANATION**

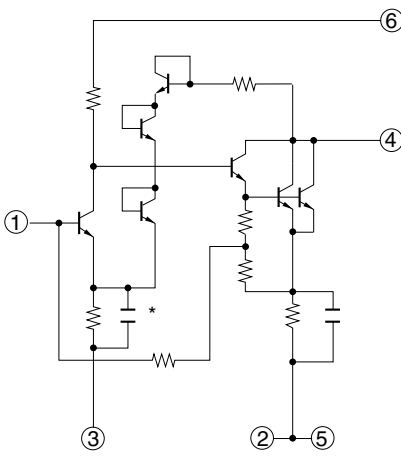
Pin No.	Pin Name	Applied Voltage (V)	Pin Voltage (V) <sup>Note</sup>	Function and Applications	Internal Equivalent Circuit
1	INPUT	–	1.31 ----- 1.01 ----- 0.97	Signal input pin. A internal matching circuit, configured with resistors, enables 50 $\Omega$ connection over a wide band. A multi-feedback circuit is designed to cancel the deviations of $h_{FE}$ and resistance. This pin must be coupled to signal source with capacitor for DC cut.	 <p>* <math>\mu</math>PC2762TB does not have this capacitance.</p>
2 3 5	GND	0	–	Ground pin. This pin should be connected to system ground with minimum inductance. Ground pattern on the board should be formed as wide as possible. All the ground pins must be connected together with wide ground pattern to decrease impedance difference.	
4	OUTPUT	Voltage as same as $V_{CC}$ through external inductor	–	Signal output pin. The inductor must be attached between $V_{CC}$ and output pins to supply current to the internal output transistors.	
6	$V_{CC}$	2.7 to 3.3	–	Power supply pin, which biases the internal input transistor. This pin should be externally equipped with bypass capacitor to minimize its impedance.	

**Note** Pin voltage is measured at  $V_{CC} = 3.0$  V. Above:  $\mu$ PC2762TB, Center:  $\mu$ PC2763TB, Below:  $\mu$ PC2771TB.

**ABSOLUTE MAXIMUM RATINGS**

Parameter	Symbol	Conditions	Ratings		Unit
			$\mu$ PC2762TB $\mu$ PC2763TB	$\mu$ PC2771TB	
Supply Voltage	V <sub>CC</sub>	T <sub>A</sub> = +25°C, pin 4 and pin 6	3.6		V
Total Circuit Current	I <sub>CC</sub>	T <sub>A</sub> = +25°C	70	77.7	mA
Power Dissipation	P <sub>D</sub>	Mounted on double copper clad 50 × 50 × 1.6 mm epoxy glass PWB, T <sub>A</sub> = +85°C	270		mW
Operating Ambient Temperature	T <sub>A</sub>		-40 to +85		°C
Storage Temperature	T <sub>stg</sub>		-55 to +150		°C
Input Power	P <sub>in</sub>	T <sub>A</sub> = +25°C	+10	+13	dBm

★

**RECOMMENDED OPERATING RANGE**

Parameter	Symbol	MIN.	TYP.	MAX.	Unit	Remark
Supply Voltage	V <sub>CC</sub>	2.7	3.0	3.3	V	Same voltage should be applied to pin 4 and pin 6.
Operating Frequency	f <sub>opt</sub>	0.8	–	1.9	GHz	Only for $\mu$ PC2771TB

**ELECTRICAL CHARACTERISTICS**

(Unless otherwise specified,  $T_A = +25^\circ\text{C}$ ,  $V_{CC} = V_{out} = 3.0\text{ V}$ ,  $Z_s = Z_L = 50\ \Omega$ )

**$\mu$ PC2762TB,  $\mu$ PC2763TB**

Parameter	Symbol	Test Conditions	$\mu$ PC2762TB			$\mu$ PC2763TB			Unit
			MIN.	TYP.	MAX.	MIN.	TYP.	MAX.	
Circuit Current	$I_{CC}$	No signal	–	26.5	35.0	–	27.0	35.0	mA
Power Gain	$G_P$	f = 0.9 GHz f = 1.9 GHz	11 11.5	13 15.5	16 17.5	18 18	20 21	23 24	dB
Noise Figure	NF	f = 0.9 GHz f = 1.9 GHz	– –	6.5 7.0	8.0 9.0	– –	5.5 5.5	7.0 7.5	dB
Upper Limit Operating Frequency	$f_u$	3 dB down below from gain at f = 0.1 GHz	2.7	2.9	–	2.3	2.7	–	GHz
Isolation	ISL	f = 0.9 GHz f = 1.9 GHz	22 20	27 25	– –	25 24	30 29	– –	dB
Input Return Loss	$RL_{in}$	f = 0.9 GHz f = 1.9 GHz	6.0 5.5	9.0 8.5	– –	8.0 8.0	11.0 11.0	– –	dB
Output Return Loss	$RL_{out}$	f = 0.9 GHz f = 1.9 GHz	8.0 9.0	11.0 12.0	– –	5.0 6.0	7.0 9.0	– –	dB
1 dB Gain Compression Output Power	$P_{O(1\text{ dB})}$	f = 0.9 GHz f = 1.9 GHz	+5.5 +4.5	+8.0 +7.0	– –	+7.0 +4.0	+9.5 +6.5	– –	dBm

**$\mu$ PC2771TB**

Parameter	Symbol	Test Conditions	$\mu$ PC2771TB			Unit
			MIN.	TYP.	MAX.	
Circuit Current	$I_{CC}$	No signal	–	36.0	45.0	mA
Power Gain	$G_P$	f = 0.9 GHz f = 1.5 GHz	19 18	21 21	24 24	dB
Noise Figure	NF	f = 0.9 GHz f = 1.5 GHz	– –	6.0 6.0	7.5 7.5	dB
Upper Limit Operating Frequency	$f_u$	3 dB down below from gain at f = 0.1 GHz	1.8	2.2	–	GHz
Isolation	ISL	f = 0.9 GHz f = 1.5 GHz	25 25	30 30	– –	dB
Input Return Loss	$RL_{in}$	f = 0.9 GHz f = 1.5 GHz	10 10	14 14	– –	dB
Output Return Loss	$RL_{out}$	f = 0.9 GHz f = 1.5 GHz	6.5 5.5	9.0 8.5	– –	dB
1 dB Gain Compression Output Power	$P_{O(1\text{ dB})}$	f = 0.9 GHz f = 1.5 GHz	+9.0 +7.0	+11.5 +9.5	– –	dBm
Saturated Output Power	$P_{O(sat)}$	f = 0.9 GHz f = 1.5 GHz	– –	+12.5 +11.0	– –	dBm

**STANDARD CHARACTERISTICS FOR REFERENCE**

(Unless otherwise specified,  $T_A = +25^\circ\text{C}$ ,  $V_{CC} = V_{out} = 3.0\text{ V}$ ,  $Z_s = Z_L = 50\ \Omega$ )

**$\mu$ PC2762TB,  $\mu$ PC2763TB**

Parameter	Symbol	Test Conditions		Reference						Unit
				$\mu$ PC2762TB			$\mu$ PC2763TB			
				MIN.	TYP.	MAX.	MIN.	TYP.	MAX.	
Saturated Output Power	$P_{O(sat)}$	f = 0.9 GHz		–	+9.0	–	–	+11.0	–	dBm
		f = 1.9 GHz		–	+8.5	–	–	+8.0	–	
Adjacent Channel Power	$P_{adj}$	f = 0.9 GHz $\pi/4$ QPSK wave <sup>Note</sup> $P_o = +4\text{ dBm}$	$\Delta f = \pm 50\text{ kHz}$	–	–64	–	–	–61	–	dBc
			$\Delta f = \pm 100\text{ kHz}$	–	–64	–	–	–62	–	
3rd Order Intermodulation Distortion	$IM_3$	2 sine wave input. Output of each tone $P_o(\text{each}) = +4\text{ dBm}$	f <sub>1</sub> = 0.900 GHz f <sub>2</sub> = 0.902 GHz	–	–16	–	–	–27	–	dBc
			f <sub>1</sub> = 1.900 GHz f <sub>2</sub> = 1.902 GHz	–	–10	–	–	–14	–	

**Note**  $\pi/4$  DQPSK modulated wave input, data rate 42 kbps, Filter roll off  $\alpha = 0.5$ , PN 9

**$\mu$ PC2771TB**

Parameter	Symbol	Test Conditions		Reference			Unit
				MIN.	TYP.	MAX.	
Adjacent Channel Power 1	$P_{adj1}$	f = 0.9 GHz $\pi/4$ QPSK wave <sup>Note</sup> $P_o = +7\text{ dBm}$	$\Delta f = \pm 50\text{ kHz}$ $\Delta f = \pm 100\text{ kHz}$	– –	–61 –72	– –	dBc
Adjacent Channel Power 2	$P_{adj2}$	f = 1.5 GHz $\pi/4$ QPSK wave <sup>Note</sup> $P_o = +7\text{ dBm}$	$\Delta f = \pm 50\text{ kHz}$ $\Delta f = \pm 100\text{ kHz}$	– –	–59 –71	– –	
3rd Order Intermodulation Distortion	$IM_3$	2 sine wave input. Output of each tone $P_o(\text{each}) = +7\text{ dBm}$	f <sub>1</sub> = 0.900 GHz f <sub>2</sub> = 0.902 GHz	–	–18	–	dBc
			f <sub>1</sub> = 1.500 GHz f <sub>2</sub> = 1.502 GHz	–	–12	–	

**Note**  $\pi/4$  DQPSK modulated wave input, data rate 42 kbps, Filter roll off  $\alpha = 0.5$ , PN 9

**TEST CIRCUIT**

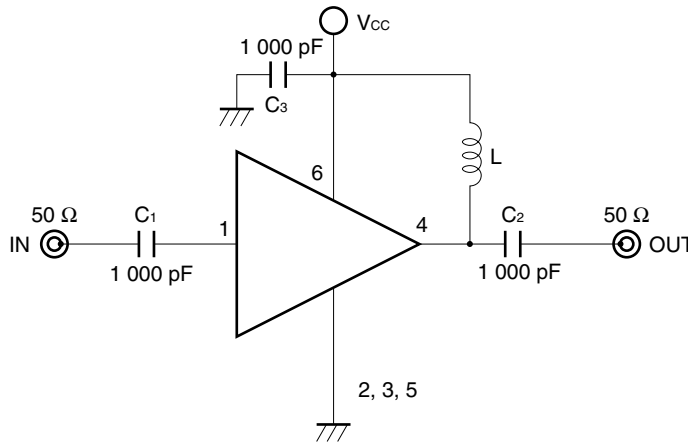

**COMPONENTS OF TEST CIRCUIT FOR MEASURING ELECTRICAL CHARACTERISTICS**

	Type	Value
C <sub>1</sub> , C <sub>2</sub>	Bias Tee	1 000 pF
C <sub>3</sub>	Capacitor	1 000 pF
L	Bias Tee	1 000 nH

**EXAMPLE OF ACTUAL APPLICATION COMPONENTS**

	Type	Value	Operating Frequency
C <sub>1</sub> to C <sub>3</sub>	Chip capacitor	1 000 pF	100 MHz or higher
L	Chip inductor	100 nH	100 MHz or higher
		10 nH	2.0 GHz or higher

**INDUCTOR FOR THE OUTPUT PIN**

The internal output transistor of this IC consumes 20 mA, to output medium power. To supply current for output transistor, connect an inductor between the Vcc pin (pin 6) and output pin (pin 4). Select large value inductance, as listed above.

The inductor has both DC and AC effects. In terms of DC, the inductor biases the output transistor with minimum voltage drop to output enable high level. In terms of AC, the inductor make output-port-impedance higher to get enough gain. In this case, large inductance and Q is suitable.

For above reason, select an inductance of 100 Ω or over impedance in the operating frequency. The gain is a peak in the operating frequency band, and suppressed at lower frequencies.

The recommendable inductance can be chosen from example of actual application components list as shown above.

**CAPACITORS FOR THE Vcc, INPUT, AND OUTPUT PINS**

Capacitors of 1 000 pF are recommendable as the bypass capacitor for the Vcc pin and the coupling capacitors for the input and output pins.

The bypass capacitor connected to the Vcc pin is used to minimize ground impedance of Vcc pin. So, stable bias can be supplied against Vcc fluctuation.

The coupling capacitors, connected to the input and output pins, are used to cut the DC and minimize RF serial impedance. Their capacitance are therefore selected as lower impedance against a 50 Ω load. The capacitors thus perform as high pass filters, suppressing low frequencies to DC.

To obtain a flat gain from 100 MHz upwards, 1 000 pF capacitors are used in the test circuit. In the case of under 10 MHz operation, increase the value of coupling capacitor such as 10 000 pF. Because the coupling capacitors are determined by equation,  $C = 1/(2\pi Rf_c)$ .



ILLUSTRATION OF THE TEST CIRCUIT ASSEMBLED ON EVALUATION BOARD

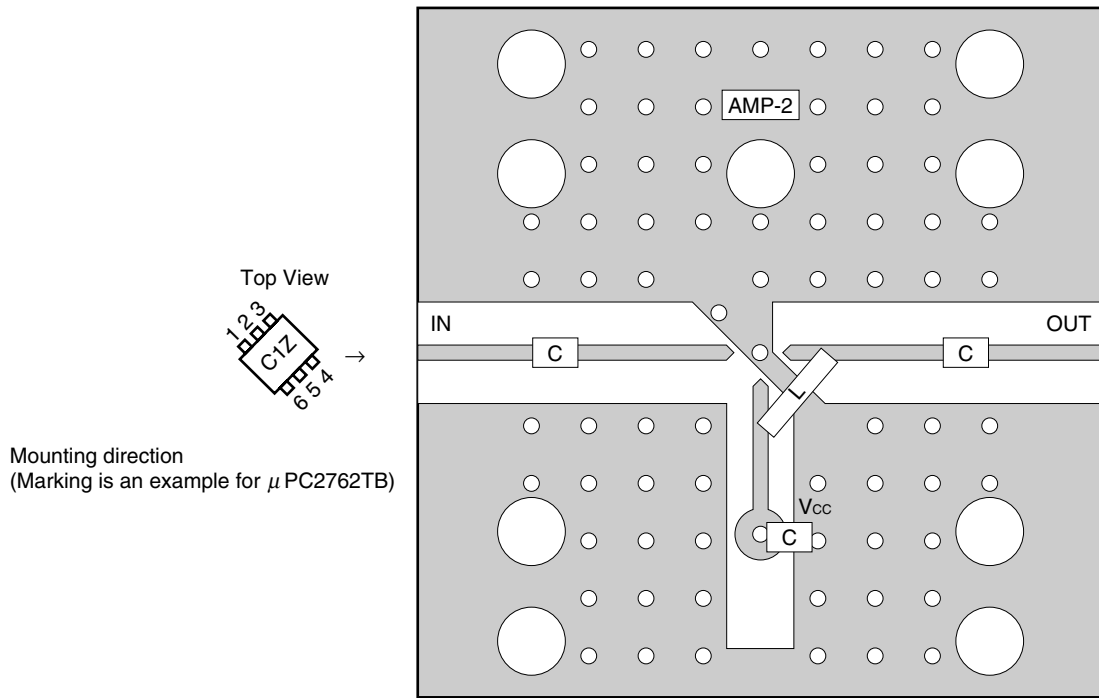

COMPONENT LIST

	Value
C	1 000 pF
L	Example: 10 nH

Notes

1. 30 × 30 × 0.4 mm double sided copper clad polyimide board.
2. Back side: GND pattern
3. Solder plated on pattern
4. ○ ○ : Through holes

For more information on the use of this IC, refer to the following application note: **USAGE AND APPLICATIONS OF 6-PIN SUPER MINI-MOLD SILICON MEDIUM-POWER HIGH-FREQUENCY AMPLIFIER MMIC (P13252E).**

TYPICAL CHARACTERISTICS (Unless otherwise specified,  $T_A = +25^\circ\text{C}$ )

–  $\mu$ PC2762TB –

CIRCUIT CURRENT vs. SUPPLY VOLTAGE

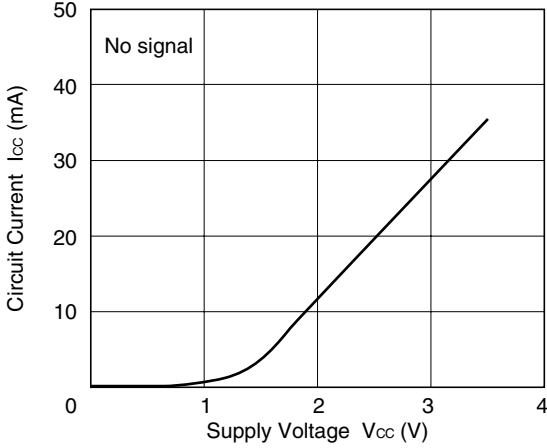

CIRCUIT CURRENT vs. OPERATING AMBIENT TEMPERATURE

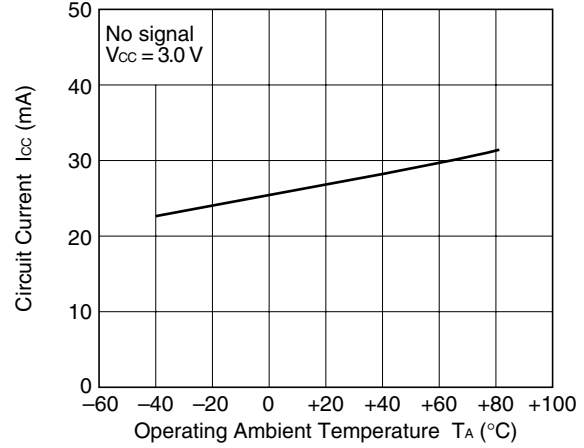

NOISE FIGURE, POWER GAIN vs. FREQUENCY

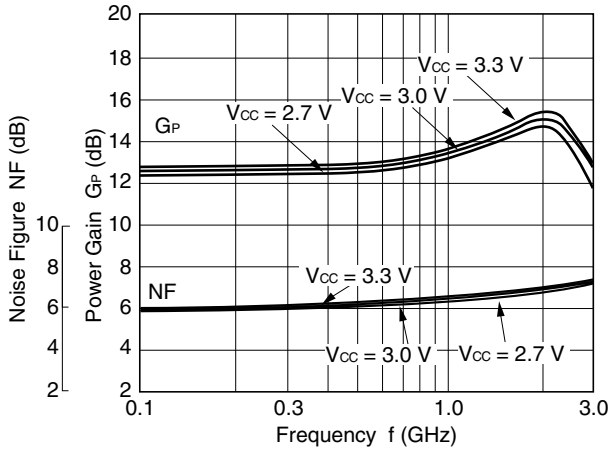

POWER GAIN vs. FREQUENCY

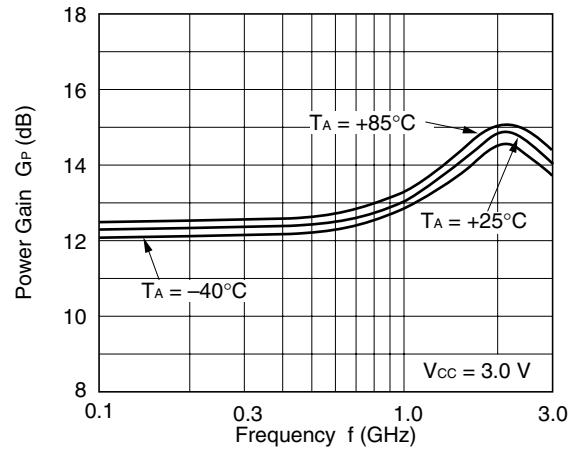

ISOLATION vs. FREQUENCY

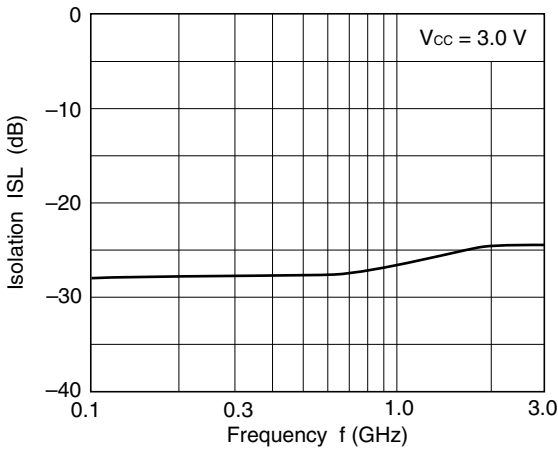

INPUT RETURN LOSS, OUTPUT RETURN LOSS vs. FREQUENCY

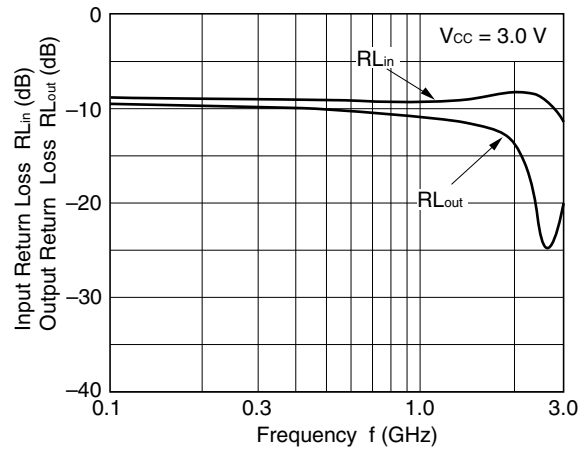

-  $\mu$ PC2762TB -

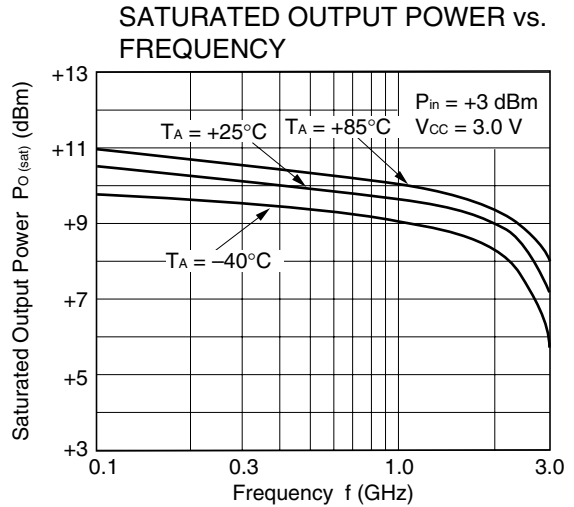
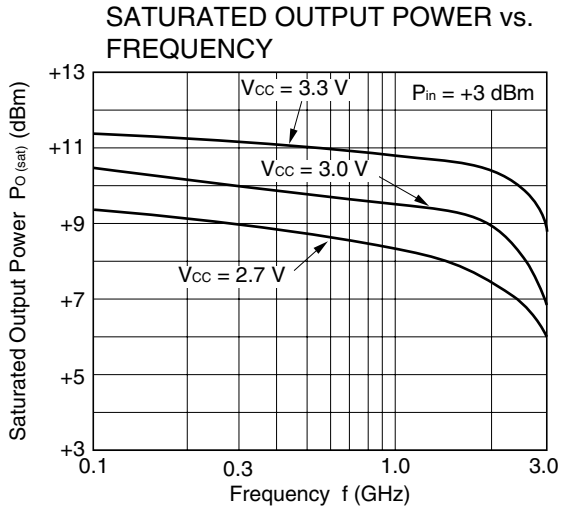
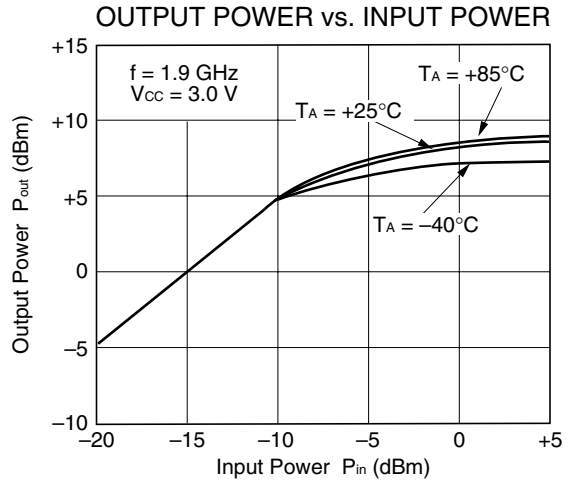
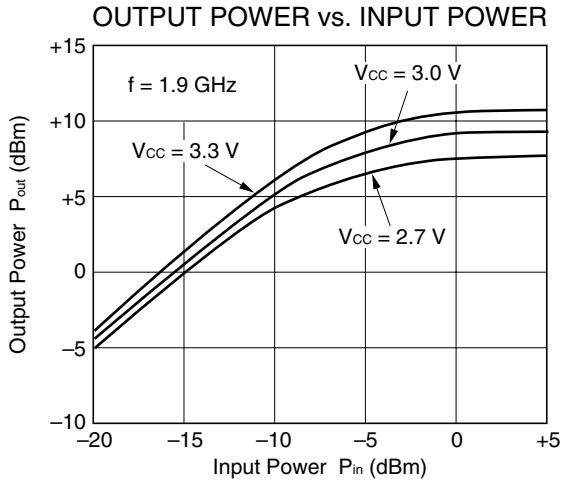
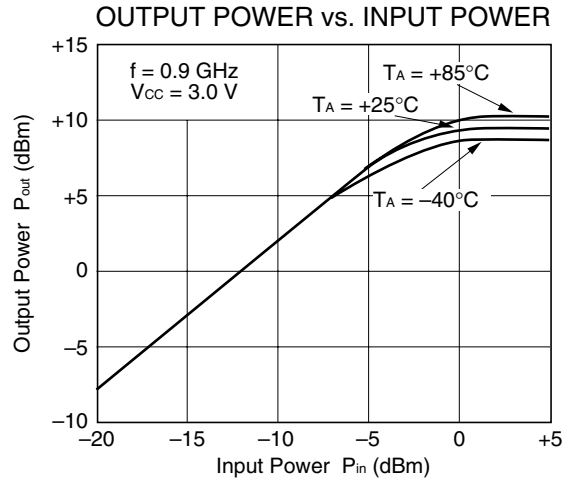
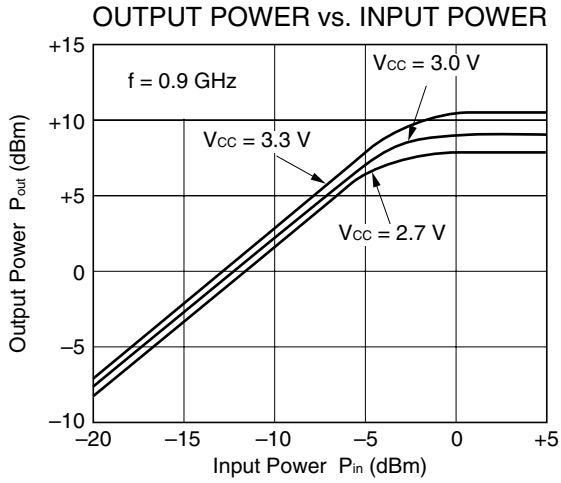

–  $\mu$ PC2762TB –

3RD ORDER INTERMODULATION DISTORTION vs. OUTPUT POWER OF EACH TONE

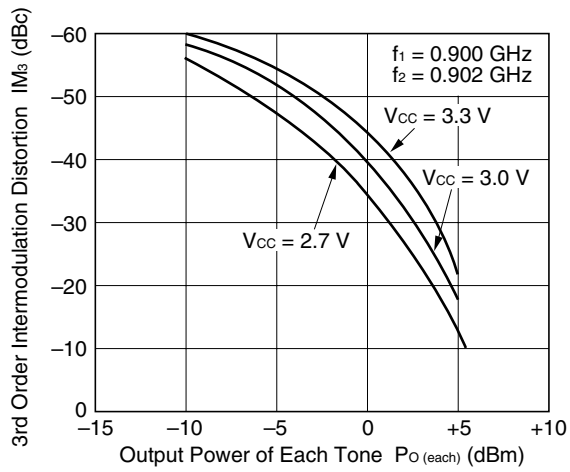

3RD ORDER INTERMODULATION DISTORTION vs. OUTPUT POWER OF EACH TONE

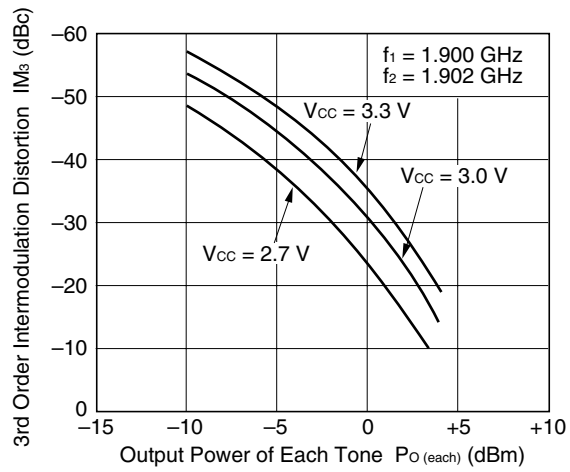

**Remark** The graphs indicate nominal characteristics.

**S-PARAMETERS (T<sub>A</sub> = +25°C, V<sub>CC</sub> = V<sub>out</sub> = 3.0 V)**

–  $\mu$ PC2762TB –

**S<sub>11</sub>-FREQUENCY**

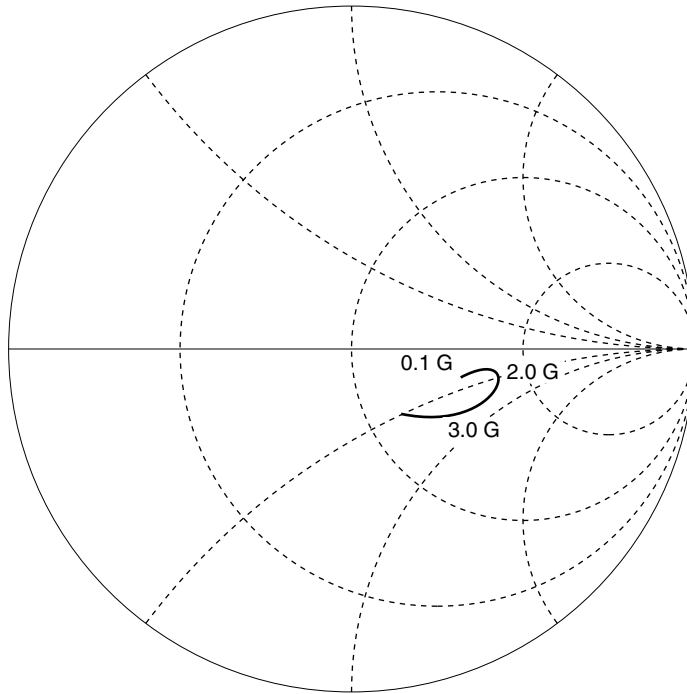

**S<sub>22</sub>-FREQUENCY**

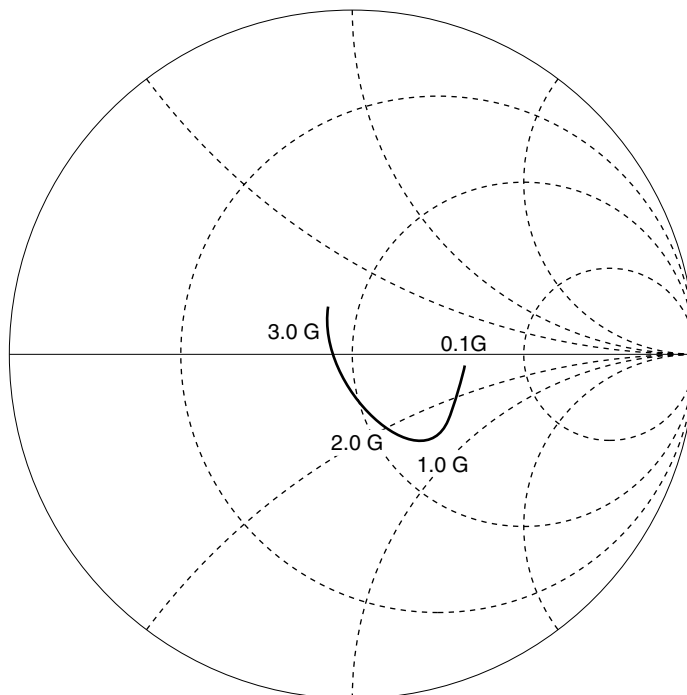

**TYPICAL S-PARAMETER VALUES (T<sub>A</sub> = +25°C)**

$\mu$ PC2762TB

V<sub>CC</sub> = V<sub>out</sub> = 3.0 V, I<sub>CC</sub> = 29 mA

FREQUENCY MHz	S <sub>11</sub>		S <sub>21</sub>		S <sub>12</sub>		S <sub>22</sub>		K
	MAG.	ANG.	MAG.	ANG.	MAG.	ANG.	MAG.	ANG.	
100.0000	0.338	-1.3	4.560	-3.4	0.039	1.0	0.310	-5.5	2.23
200.0000	0.346	-2.0	4.581	-7.6	0.039	2.7	0.311	-9.5	2.20
300.0000	0.348	-1.2	4.616	-11.3	0.039	6.8	0.302	-12.3	2.20
400.0000	0.340	-1.9	4.661	-15.8	0.040	8.1	0.296	-16.2	2.18
500.0000	0.329	-3.1	4.689	-19.5	0.040	11.6	0.290	-20.2	2.20
600.0000	0.324	-6.2	4.726	-23.6	0.041	13.7	0.292	-24.1	2.12
700.0000	0.341	-8.1	4.844	-27.4	0.042	15.8	0.291	-26.2	2.01
800.0000	0.359	-7.6	4.927	-31.5	0.043	18.1	0.292	-28.3	1.90
900.0000	0.378	-6.5	5.057	-35.8	0.044	19.3	0.284	-30.9	1.77
1000.0000	0.375	-5.1	5.179	-41.0	0.045	20.3	0.280	-35.3	1.72
1100.0000	0.363	-5.2	5.306	-45.9	0.047	22.1	0.285	-40.0	1.64
1200.0000	0.353	-6.7	5.400	-51.0	0.047	23.7	0.288	-43.4	1.62
1300.0000	0.357	-8.8	5.567	-56.5	0.048	26.1	0.288	-45.7	1.54
1400.0000	0.377	-11.7	5.706	-61.7	0.049	24.5	0.285	-47.9	1.44
1500.0000	0.402	-12.7	5.820	-68.0	0.052	26.7	0.282	-52.8	1.32
1600.0000	0.414	-13.2	5.987	-73.7	0.052	26.8	0.285	-58.1	1.27
1700.0000	0.426	-13.6	6.081	-80.1	0.055	29.0	0.288	-62.0	1.18
1800.0000	0.434	-16.1	6.182	-86.7	0.056	28.2	0.291	-66.1	1.14
1900.0000	0.448	-19.0	6.229	-93.2	0.057	28.5	0.286	-70.4	1.09
2000.0000	0.463	-21.7	6.328	-99.7	0.057	28.0	0.282	-76.2	1.07
2100.0000	0.483	-23.9	6.382	-106.7	0.058	28.5	0.282	-81.5	1.01
2200.0000	0.492	-25.8	6.431	-113.8	0.058	29.0	0.282	-86.9	0.99
2300.0000	0.492	-29.7	6.424	-121.2	0.060	30.1	0.278	-91.7	0.99
2400.0000	0.486	-34.6	6.329	-128.8	0.060	30.2	0.268	-98.4	1.01
2500.0000	0.489	-40.4	6.146	-136.1	0.062	31.1	0.260	-104.5	1.02
2600.0000	0.500	-44.6	5.997	-143.1	0.061	32.1	0.251	-111.3	1.05
2700.0000	0.511	-48.5	5.822	-149.9	0.064	31.4	0.248	-116.7	1.03
2800.0000	0.511	-50.4	5.693	-157.0	0.066	34.0	0.237	-121.5	1.04
2900.0000	0.494	-52.9	5.553	-163.0	0.065	33.8	0.222	-128.3	1.11
3000.0000	0.465	-55.9	5.334	-169.5	0.065	35.5	0.203	-134.5	1.20
3100.0000	0.441	-60.6	5.157	-175.5	0.066	35.5	0.189	-141.1	1.27

TYPICAL CHARACTERISTICS (Unless otherwise specified,  $T_A = +25^\circ\text{C}$ )

–  $\mu$ PC2763TB –

CIRCUIT CURRENT vs. SUPPLY VOLTAGE

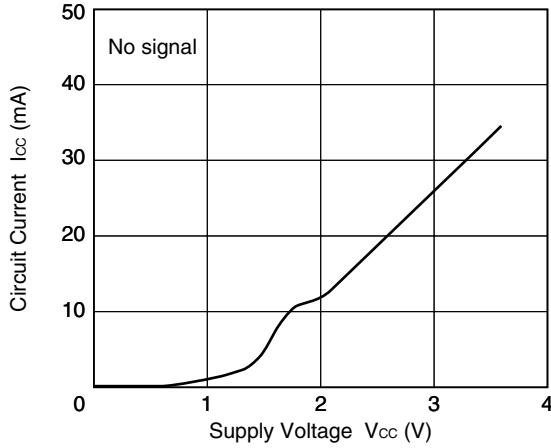

CIRCUIT CURRENT vs. OPERATING AMBIENT TEMPERATURE

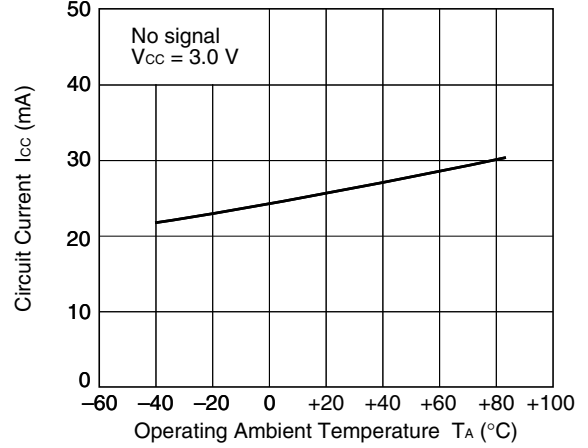

NOISE FIGURE, POWER GAIN vs. FREQUENCY

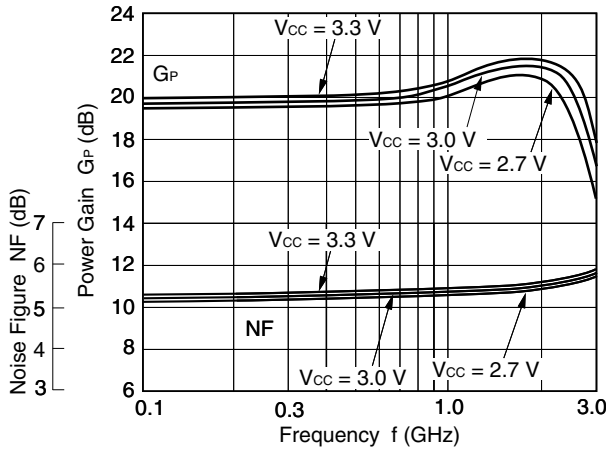

POWER GAIN vs. FREQUENCY

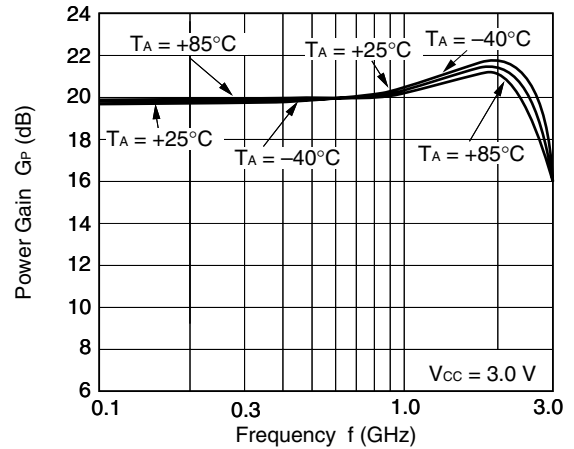

ISOLATION vs. FREQUENCY

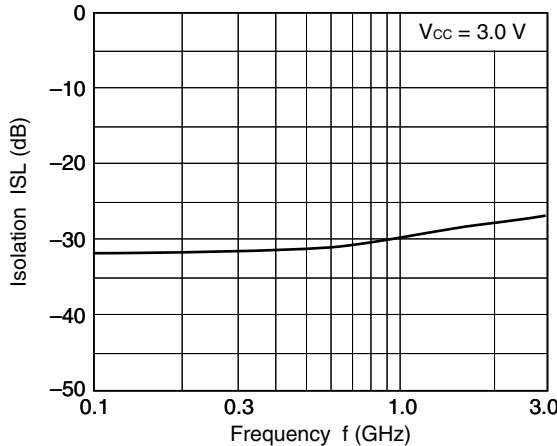

INPUT RETURN LOSS, OUTPUT RETURN LOSS vs. FREQUENCY

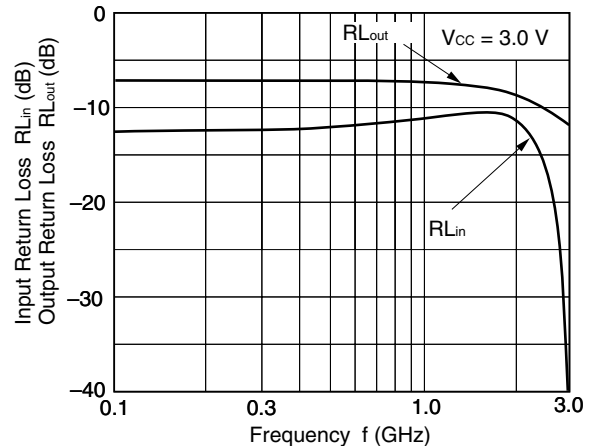

-  $\mu$ PC2763TB -

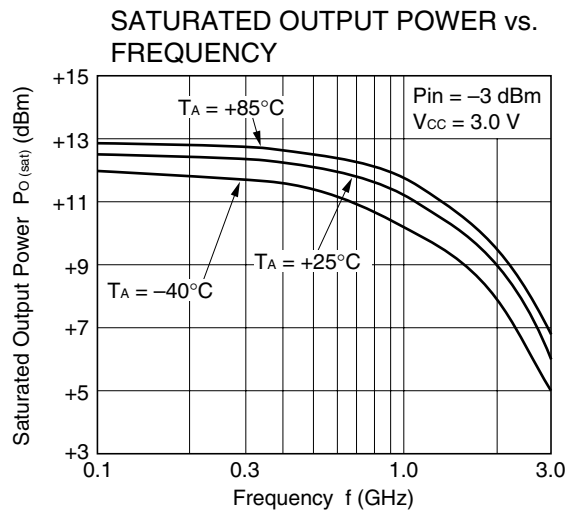
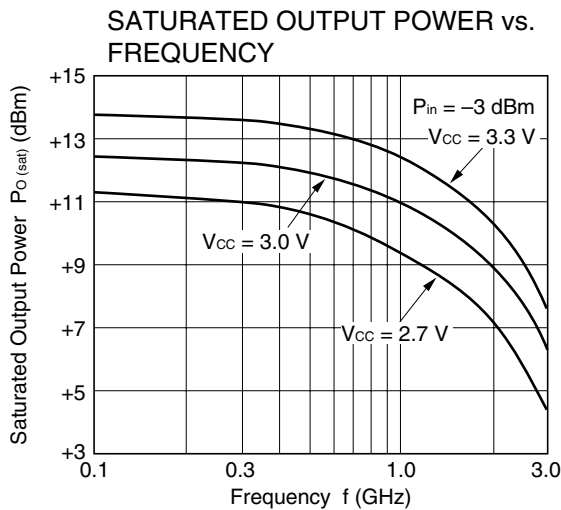
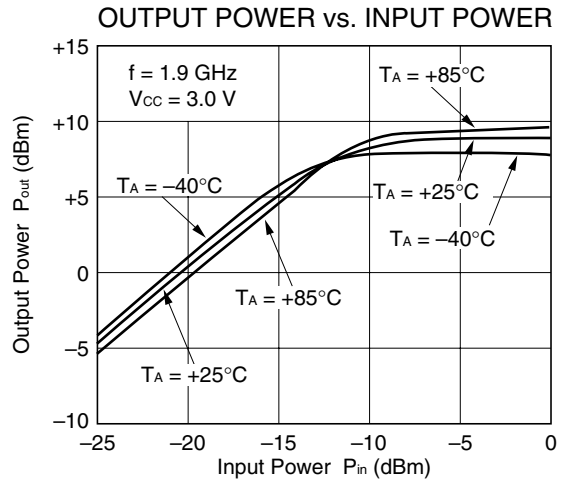
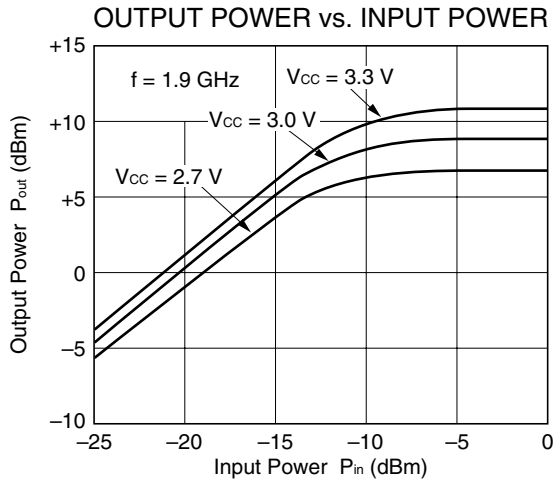
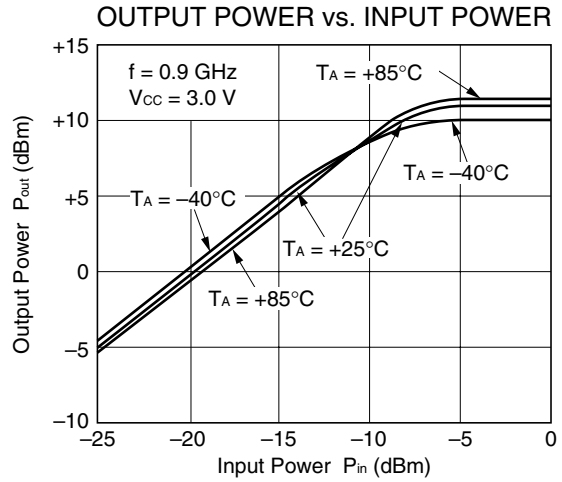
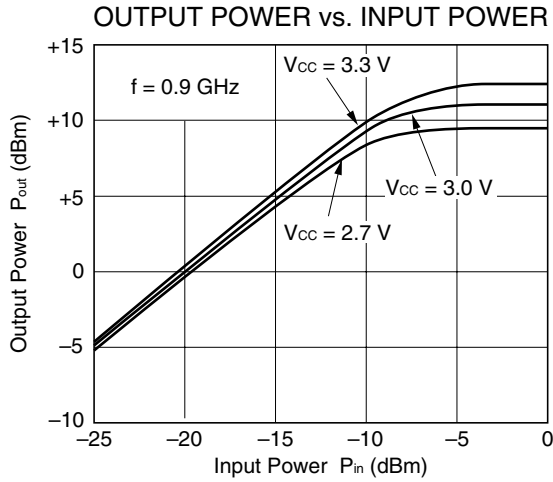



-  $\mu$ PC2763TB -

3RD ORDER INTERMODULATION DISTORTION vs. OUTPUT POWER OF EACH TONE

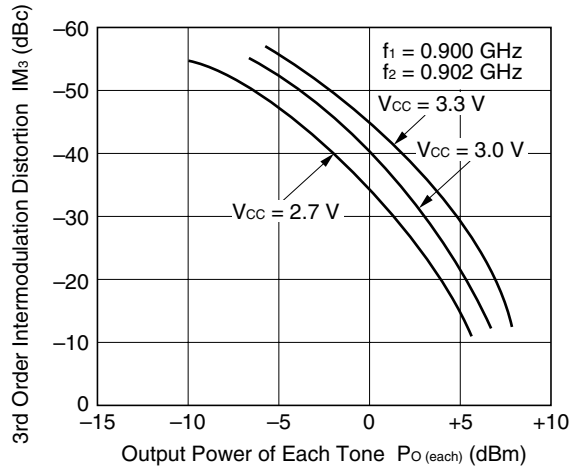

3RD ORDER INTERMODULATION DISTORTION vs. OUTPUT POWER OF EACH TONE

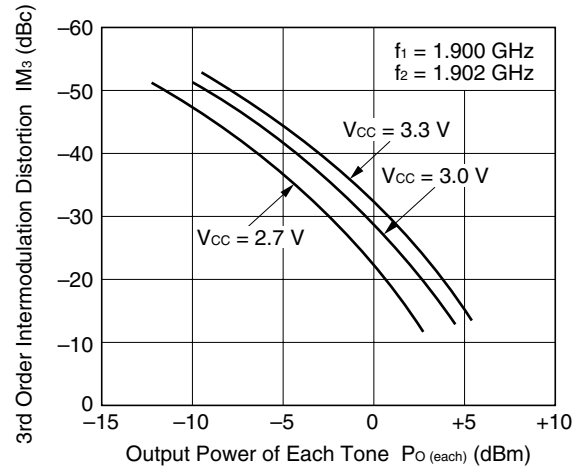

**Remark** The graphs indicate nominal characteristics.

S-PARAMETERS ( $T_A = +25^\circ\text{C}$ ,  $V_{CC} = V_{out} = 3.0\text{ V}$ )

–  $\mu$ PC2763TB –

S<sub>11</sub>-FREQUENCY

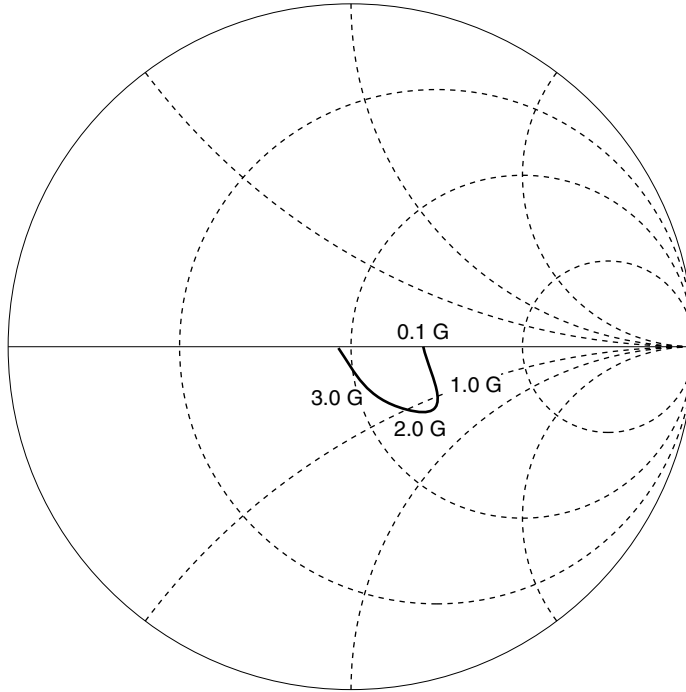

S<sub>22</sub>-FREQUENCY

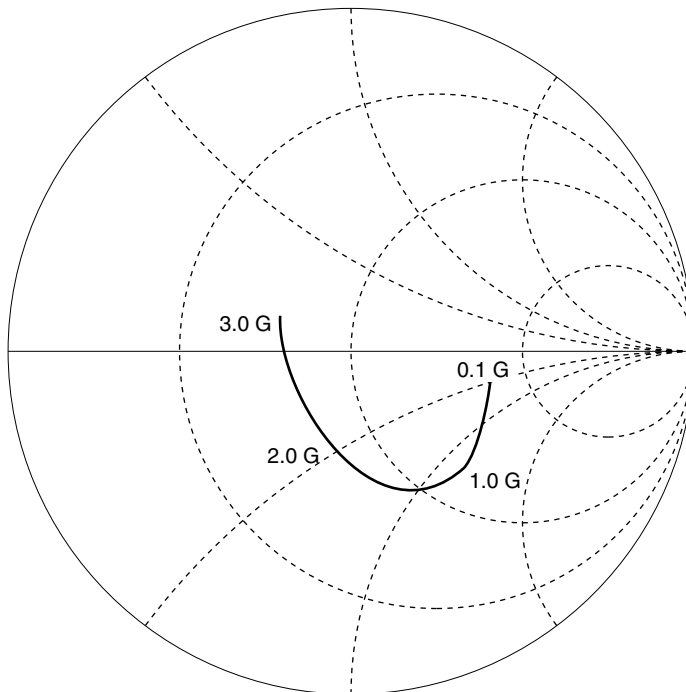

TYPICAL S-PARAMETER VALUES (T<sub>A</sub> = +25°C)

$\mu$ PC2763TB

V<sub>CC</sub> = V<sub>out</sub> = 3.0 V, I<sub>CC</sub> = 28 mA

FREQUENCY MHz	S <sub>11</sub>		S <sub>21</sub>		S <sub>12</sub>		S <sub>22</sub>		K
	MAG.	ANG.	MAG.	ANG.	MAG.	ANG.	MAG.	ANG.	
100.0000	0.231	-1.4	10.210	-3.8	0.023	2.4	0.406	-4.1	1.68
200.0000	0.242	-0.2	10.305	-8.5	0.023	7.8	0.412	-7.5	1.66
300.0000	0.250	2.7	10.464	-12.9	0.024	9.3	0.407	-9.9	1.58
400.0000	0.245	2.8	10.655	-18.2	0.024	13.4	0.407	-13.9	1.55
500.0000	0.242	2.0	10.863	-22.8	0.026	16.1	0.405	-17.6	1.44
600.0000	0.241	-2.2	11.093	-28.1	0.027	19.9	0.414	-21.6	1.37
700.0000	0.263	-5.3	11.544	-33.2	0.028	22.3	0.419	-24.6	1.25
800.0000	0.291	-5.6	11.843	-39.0	0.029	22.5	0.424	-27.7	1.16
900.0000	0.316	-5.1	12.291	-45.1	0.029	23.9	0.424	-31.9	1.09
1000.0000	0.322	-4.0	12.676	-52.4	0.030	25.6	0.425	-37.1	1.02
1100.0000	0.318	-5.4	13.066	-59.8	0.031	24.1	0.438	-42.5	0.96
1200.0000	0.309	-9.0	13.311	-67.3	0.031	27.0	0.442	-47.8	0.96
1300.0000	0.322	-14.2	13.661	-75.8	0.033	28.8	0.441	-51.2	0.90
1400.0000	0.344	-20.6	13.845	-83.9	0.033	28.5	0.434	-56.0	0.87
1500.0000	0.371	-23.7	13.824	-93.0	0.035	30.1	0.435	-62.2	0.82
1600.0000	0.380	-27.5	13.890	-101.5	0.035	28.1	0.439	-68.9	0.80
1700.0000	0.388	-30.6	13.634	-110.5	0.036	29.2	0.439	-74.6	0.78
1800.0000	0.378	-36.4	13.236	-119.6	0.035	29.9	0.428	-81.3	0.84
1900.0000	0.378	-42.1	12.724	-127.9	0.035	30.9	0.411	-87.0	0.89
2000.0000	0.375	-46.6	12.290	-136.1	0.035	32.9	0.393	-93.4	0.94
2100.0000	0.369	-50.5	11.707	-144.0	0.035	33.0	0.385	-99.6	0.99
2200.0000	0.351	-53.8	11.130	-151.7	0.036	35.7	0.373	-104.9	1.06
2300.0000	0.331	-59.8	10.524	-159.1	0.036	36.8	0.359	-110.3	1.13
2400.0000	0.306	-66.4	9.824	-165.9	0.034	38.7	0.336	-117.5	1.31
2500.0000	0.300	-73.1	9.152	-172.3	0.035	40.1	0.321	-123.3	1.41
2600.0000	0.294	-75.8	8.583	-178.2	0.034	43.8	0.306	-129.4	1.55
2700.0000	0.290	-77.1	8.029	-176.2	0.035	46.3	0.299	-133.9	1.58
2800.0000	0.270	-77.7	7.610	-170.6	0.037	47.7	0.288	-138.6	1.63
2900.0000	0.248	-78.7	7.240	-166.1	0.039	51.1	0.270	-143.6	1.67
3000.0000	0.219	-82.3	6.827	-161.2	0.039	53.6	0.253	-150.1	1.79
3100.0000	0.198	-88.7	6.516	-156.9	0.040	55.1	0.244	-156.2	1.88

TYPICAL CHARACTERISTICS (Unless otherwise specified,  $T_A = +25^\circ\text{C}$ )

-  $\mu$ PC2771TB -

CIRCUIT CURRENT vs. SUPPLY VOLTAGE

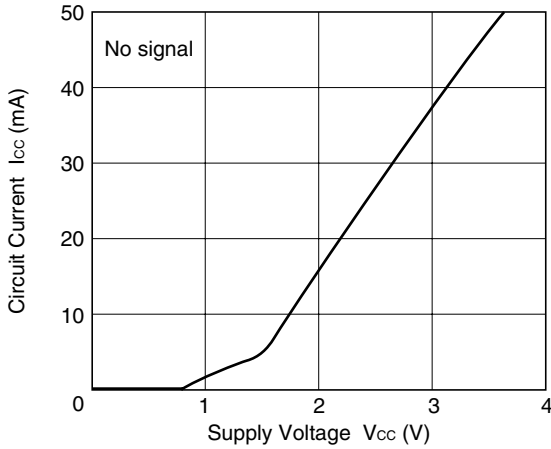

CIRCUIT CURRENT vs. OPERATING AMBIENT TEMPERATURE

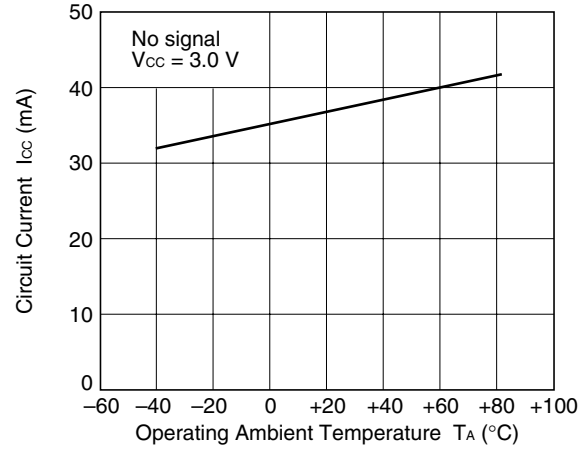

NOISE FIGURE, POWER GAIN vs. FREQUENCY

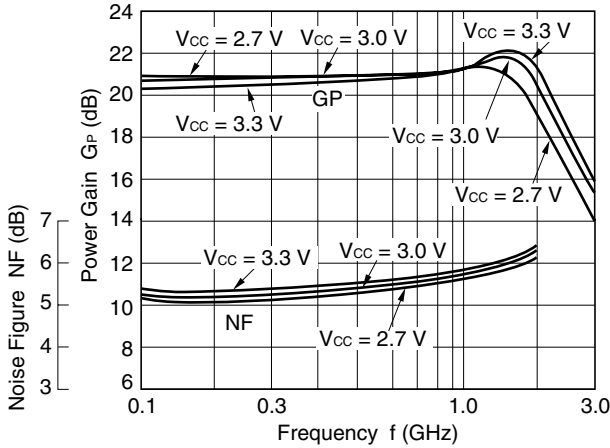

POWER GAIN vs. FREQUENCY

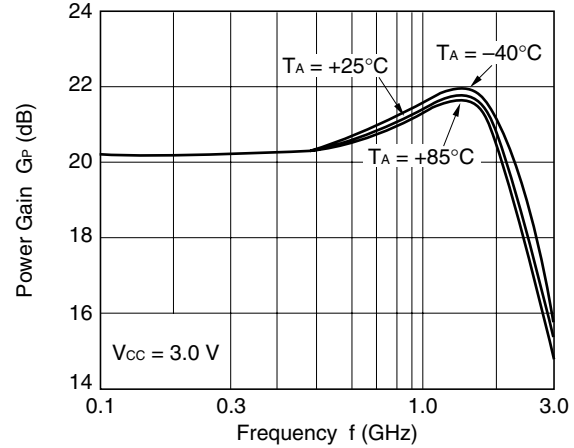

ISOLATION vs. FREQUENCY

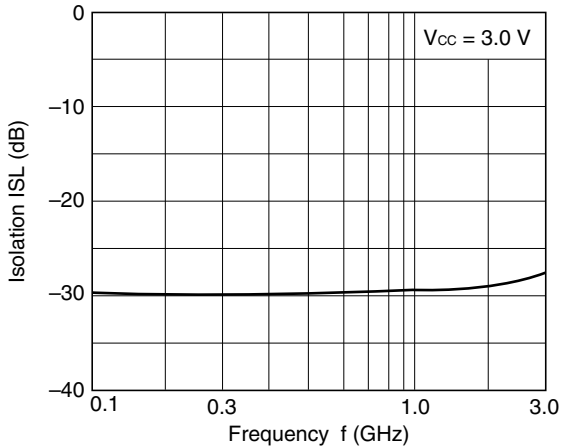

INPUT RETURN LOSS, OUTPUT RETURN LOSS vs. FREQUENCY

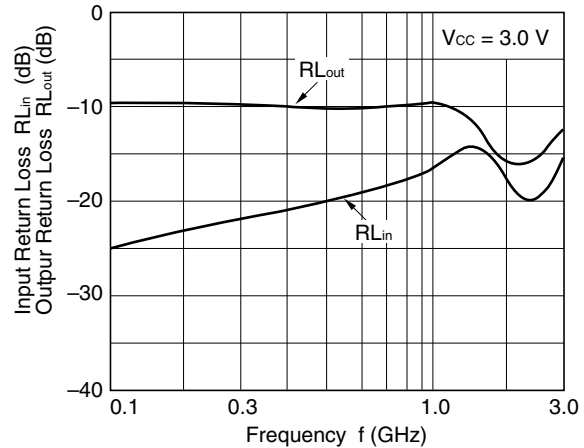

-  $\mu$ PC2771TB -

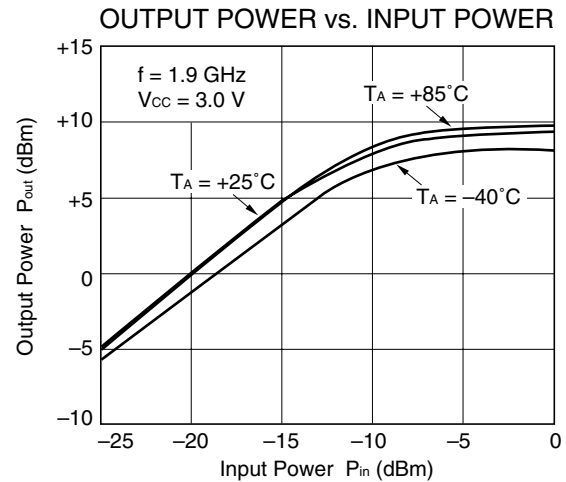
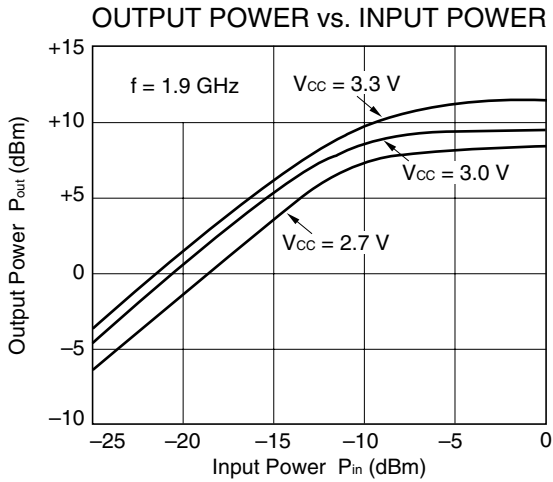
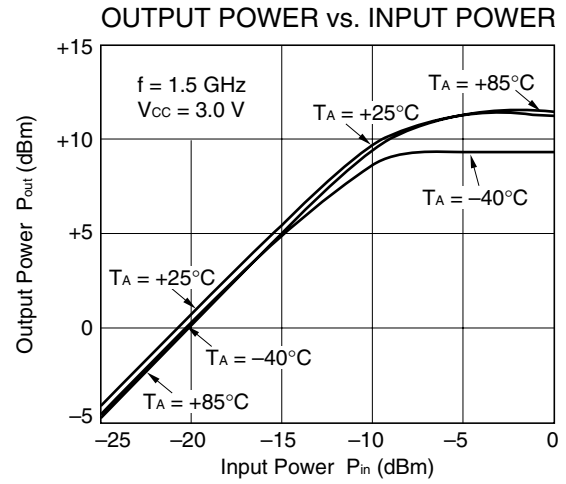
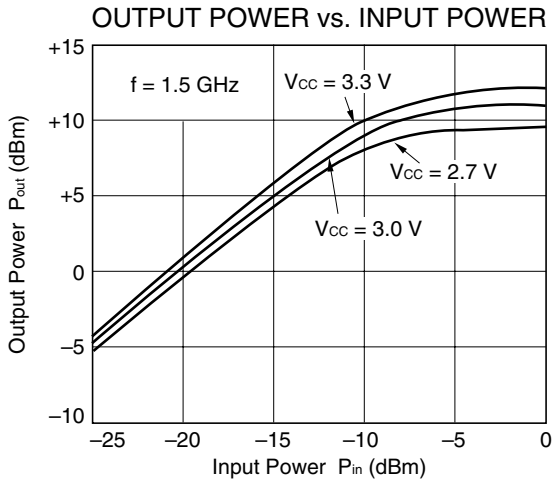
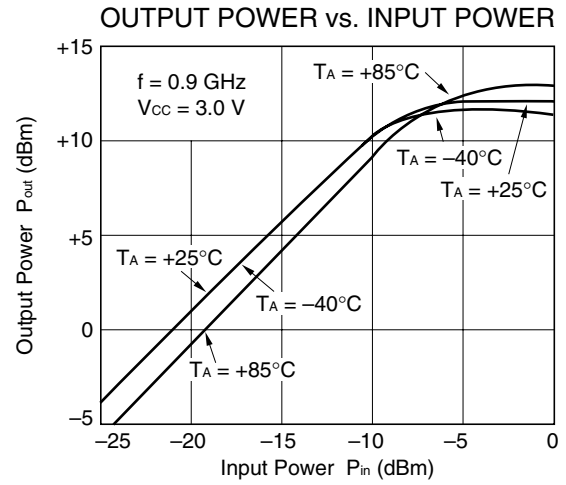
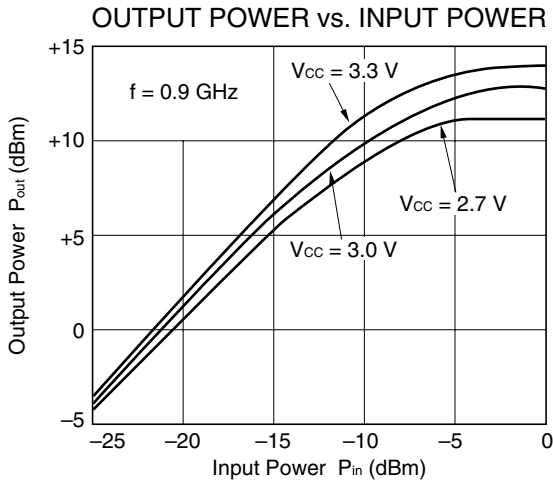

-  $\mu$ PC2771TB -

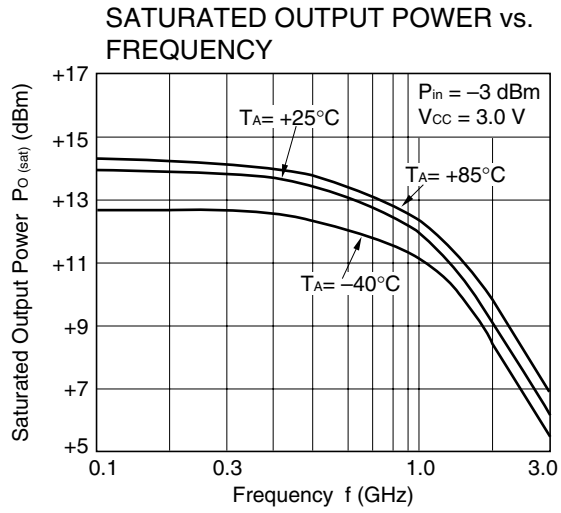
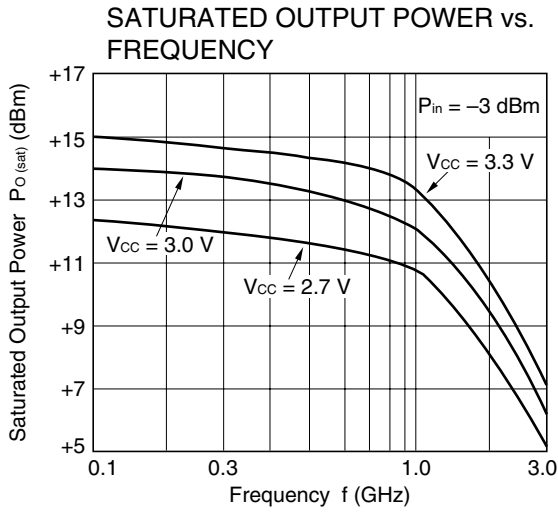

**3RD ORDER INTERMODULATION DISTORTION vs. OUTPUT POWER OF EACH TONE**

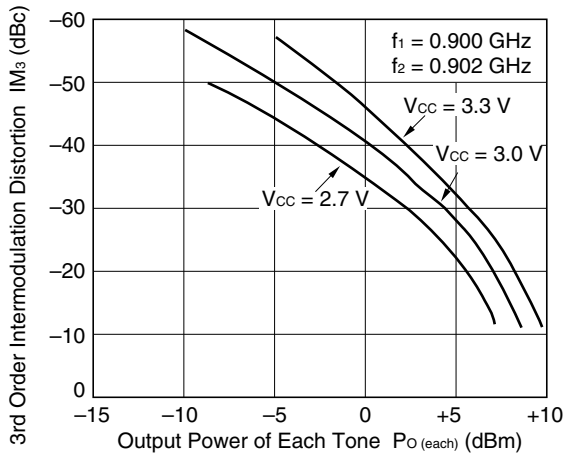

**3RD ORDER INTERMODULATION DISTORTION vs. OUTPUT POWER OF EACH TONE**

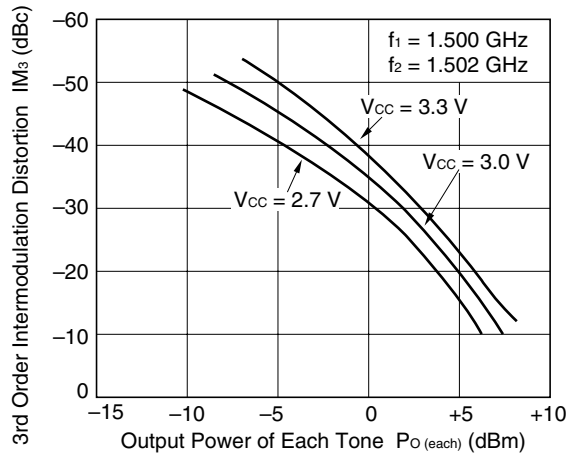

**Remark** The graphs indicate nominal characteristics.

S-PARAMETERS ( $T_A = +25^\circ\text{C}$ ,  $V_{CC} = V_{out} = 3.0\text{ V}$ )

–  $\mu$ PC2771TB –

S<sub>11</sub>-FREQUENCY

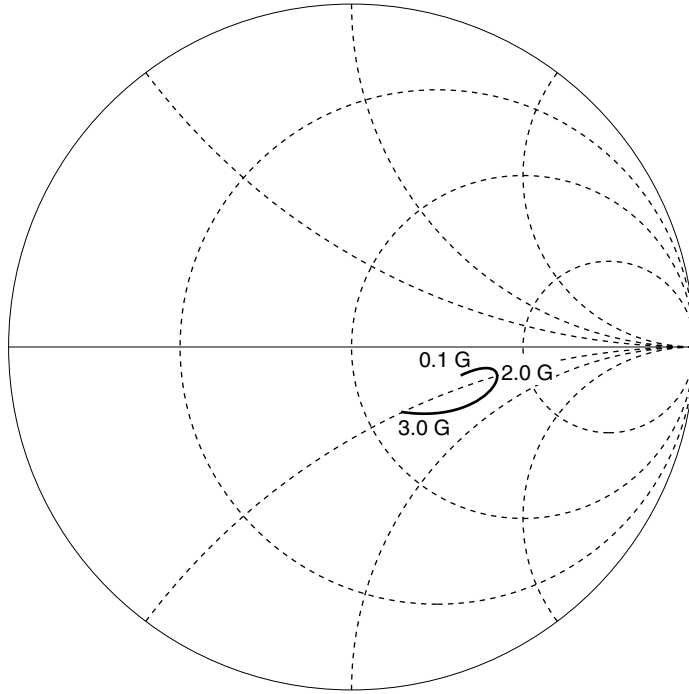

S<sub>22</sub>-FREQUENCY

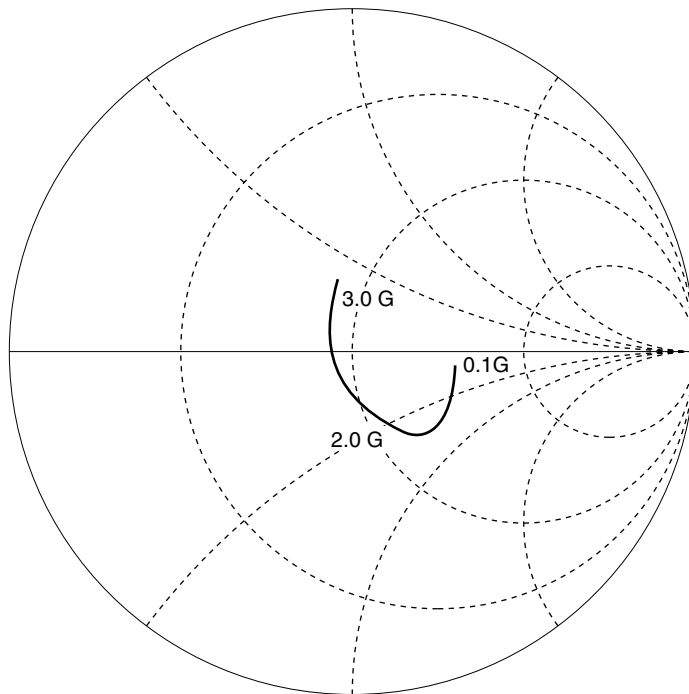

TYPICAL S-PARAMETER VALUES (T<sub>A</sub> = +25°C)

$\mu$ PC2771TB

V<sub>CC</sub> = V<sub>out</sub> = 3.0 V, I<sub>CC</sub> = 35 mA

FREQUENCY MHz	S <sub>11</sub>		S <sub>21</sub>		S <sub>12</sub>		S <sub>22</sub>		K
	MAG.	ANG.	MAG.	ANG.	MAG.	ANG.	MAG.	ANG.	
100.0000	0.045	19.7	10.570	-4.7	0.028	0.8	0.327	-6.2	1.65
200.0000	0.057	37.0	10.638	-9.5	0.028	5.0	0.325	-11.5	1.63
300.0000	0.075	41.3	10.775	-14.1	0.029	8.6	0.323	-16.2	1.58
400.0000	0.090	43.3	11.004	-19.4	0.030	11.1	0.326	-20.9	1.49
500.0000	0.105	42.2	11.275	-24.4	0.030	14.9	0.331	-26.4	1.45
600.0000	0.118	40.2	11.586	-30.0	0.031	15.8	0.342	-32.0	1.37
700.0000	0.138	34.9	12.041	-35.9	0.031	19.8	0.350	-37.3	1.29
800.0000	0.163	32.5	12.367	-42.1	0.032	20.1	0.359	-42.8	1.20
900.0000	0.186	29.4	12.844	-48.8	0.032	23.2	0.361	-49.4	1.15
1000.0000	0.202	26.3	13.300	-56.6	0.032	23.9	0.371	-56.1	1.11
1100.0000	0.219	21.7	13.771	-64.6	0.033	24.9	0.389	-62.5	1.03
1200.0000	0.233	15.4	14.082	-73.5	0.033	26.6	0.400	-69.3	0.99
1300.0000	0.252	8.4	14.365	-83.2	0.036	28.8	0.405	-75.4	0.92
1400.0000	0.267	-0.1	14.336	-92.6	0.036	30.0	0.402	-83.6	0.91
1500.0000	0.285	-6.8	14.142	-102.4	0.036	32.0	0.406	-91.6	0.90
1600.0000	0.293	-13.9	13.929	-112.0	0.037	31.6	0.413	-99.3	0.89
1700.0000	0.304	-20.9	13.428	-121.6	0.039	32.5	0.414	-105.8	0.88
1800.0000	0.290	-28.1	12.722	-131.0	0.038	34.7	0.401	-113.7	0.96
1900.0000	0.285	-35.3	11.966	-139.6	0.038	36.1	0.387	-120.8	1.03
2000.0000	0.273	-41.8	11.232	-147.5	0.038	37.4	0.378	-127.6	1.09
2100.0000	0.267	-47.4	10.500	-154.8	0.039	39.1	0.366	-133.1	1.14
2200.0000	0.254	-51.6	9.815	-161.7	0.040	41.4	0.356	-138.0	1.20
2300.0000	0.237	-57.1	9.168	-168.0	0.041	43.7	0.342	-142.8	1.28
2400.0000	0.221	-61.1	8.570	-173.7	0.041	48.3	0.325	-148.3	1.37
2500.0000	0.212	-68.8	7.967	-179.7	0.042	48.3	0.322	-152.6	1.44
2600.0000	0.208	-72.2	7.507	-174.9	0.043	50.8	0.314	-156.7	1.49
2700.0000	0.202	-74.1	7.004	-170.0	0.045	53.7	0.309	-160.1	1.53
2800.0000	0.190	-76.3	6.667	-164.7	0.047	54.2	0.303	-164.0	1.56
2900.0000	0.178	-76.7	6.336	-160.7	0.051	57.7	0.292	-167.8	1.55
3000.0000	0.154	-82.3	6.003	-155.6	0.051	56.5	0.287	-172.8	1.62
3100.0000	0.147	-88.0	5.772	-151.3	0.054	59.3	0.279	-176.4	1.61



★ PACKAGE DIMENSIONS

6-PIN SUPER MINIMOLD (UNIT: mm)

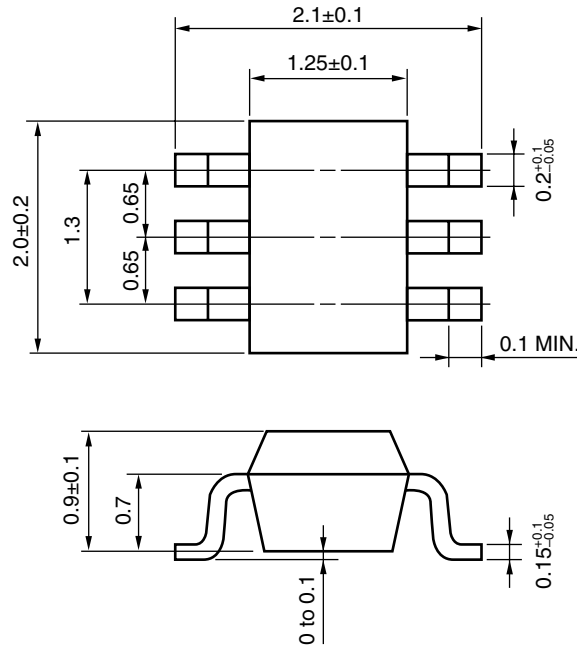

**NOTES ON CORRECT USE**

- (1) Observe precautions for handling because of electro-static sensitive devices.
- (2) Form a ground pattern as wide as possible to minimize ground impedance (to prevent undesired oscillation). All the ground pins must be connected together with wide ground pattern to decrease impedance difference.
- (3) The bypass capacitor should be attached to the Vcc pin.
- (4) The inductor must be attached between Vcc and output pins. The inductance value should be determined in accordance with desired frequency.
- (5) The DC cut capacitor must be attached to input pin.

**RECOMMENDED SOLDERING CONDITIONS**

This product should be soldered under the following recommended conditions. For soldering methods and conditions other than those recommended below, contact your NEC sales representative.

Soldering Method	Soldering Conditions	Recommended Condition Symbol
Infrared Reflow	Package peak temperature: 235°C or below Time: 30 seconds or less (at 210°C) Count: 3, Exposure limit: None <sup>Note</sup>	IR35-00-3
VPS	Package peak temperature: 215°C or below Time: 40 seconds or less (at 200°C) Count: 3, Exposure limit: None <sup>Note</sup>	VP15-00-3
Wave Soldering	Soldering bath temperature: 260°C or below Time: 10 seconds or less Count: 1, Exposure limit: None <sup>Note</sup>	WS60-00-1
Partial Heating	Pin temperature: 300°C or below Time: 3 seconds or less (per side of device) Exposure limit: None <sup>Note</sup>	—

**Note** After opening the dry pack, keep it in a place below 25°C and 65% RH for the allowable storage period.

**Caution** Do not use different soldering methods together (except for partial heating).

For details of recommended soldering conditions for surface mounting, refer to information document **SEMICONDUCTOR DEVICE MOUNTING TECHNOLOGY MANUAL (C10535E)**.

[MEMO]

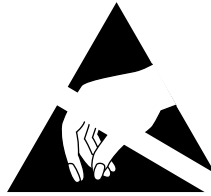

## ATTENTION

OBSERVE PRECAUTIONS  
FOR HANDLING  
ELECTROSTATIC  
SENSITIVE  
DEVICES

**NESAT (NEC Silicon Advanced Technology) is a trademark of NEC Corporation.**

- **The information in this document is current as of February, 2001. The information is subject to change without notice. For actual design-in, refer to the latest publications of NEC's data sheets or data books, etc., for the most up-to-date specifications of NEC semiconductor products. Not all products and/or types are available in every country. Please check with an NEC sales representative for availability and additional information.**
- No part of this document may be copied or reproduced in any form or by any means without prior written consent of NEC. NEC assumes no responsibility for any errors that may appear in this document.
- NEC does not assume any liability for infringement of patents, copyrights or other intellectual property rights of third parties by or arising from the use of NEC semiconductor products listed in this document or any other liability arising from the use of such products. No license, express, implied or otherwise, is granted under any patents, copyrights or other intellectual property rights of NEC or others.
- Descriptions of circuits, software and other related information in this document are provided for illustrative purposes in semiconductor product operation and application examples. The incorporation of these circuits, software and information in the design of customer's equipment shall be done under the full responsibility of customer. NEC assumes no responsibility for any losses incurred by customers or third parties arising from the use of these circuits, software and information.
- While NEC endeavours to enhance the quality, reliability and safety of NEC semiconductor products, customers agree and acknowledge that the possibility of defects thereof cannot be eliminated entirely. To minimize risks of damage to property or injury (including death) to persons arising from defects in NEC semiconductor products, customers must incorporate sufficient safety measures in their design, such as redundancy, fire-containment, and anti-failure features.
- NEC semiconductor products are classified into the following three quality grades:  
"Standard", "Special" and "Specific". The "Specific" quality grade applies only to semiconductor products developed based on a customer-designated "quality assurance program" for a specific application. The recommended applications of a semiconductor product depend on its quality grade, as indicated below. Customers must check the quality grade of each semiconductor product before using it in a particular application.
  - "Standard": Computers, office equipment, communications equipment, test and measurement equipment, audio and visual equipment, home electronic appliances, machine tools, personal electronic equipment and industrial robots
  - "Special": Transportation equipment (automobiles, trains, ships, etc.), traffic control systems, anti-disaster systems, anti-crime systems, safety equipment and medical equipment (not specifically designed for life support)
  - "Specific": Aircraft, aerospace equipment, submersible repeaters, nuclear reactor control systems, life support systems and medical equipment for life support, etc.

The quality grade of NEC semiconductor products is "Standard" unless otherwise expressly specified in NEC's data sheets or data books, etc. If customers wish to use NEC semiconductor products in applications not intended by NEC, they must contact an NEC sales representative in advance to determine NEC's willingness to support a given application.

(Note)

- (1) "NEC" as used in this statement means NEC Corporation and also includes its majority-owned subsidiaries.
- (2) "NEC semiconductor products" means any semiconductor product developed or manufactured by or for NEC (as defined above).