



T-75-45-07

DS7820A/DS8820A

DS7820A/DS8820A Dual Line Receiver

General Description

The DS7820A and the DS8820A are improved performance digital line receivers with two completely independent units fabricated on a single silicon chip. Intended for use with digital systems connected by twisted pair lines, they have a differential input designed to reject large common mode signals while responding to small differential signals. The output is directly compatible with TTL or LS integrated circuits. The response time can be controlled with an external capacitor to reject input noise spikes. The output state is a logic "1" for both inputs open. Termination resistors for the twisted pair line are also included in the circuit. Both the DS7820A and the DS8820A are specified, worst case, over

their full operating temperature range (-55°C to $+125^{\circ}\text{C}$ and 0°C to 70°C respectively), over the entire input voltage range, for $\pm 10\%$ supply voltage variations.

Features

- Operation from a single +5V logic supply
- Input voltage range of $\pm 15\text{V}$
- Strobe low forces output to "1" state
- High input resistance
- Fanout of ten with TTL integrated circuits
- Outputs can be wire OR'ed
- Series 54/74 compatible

Connection Diagram

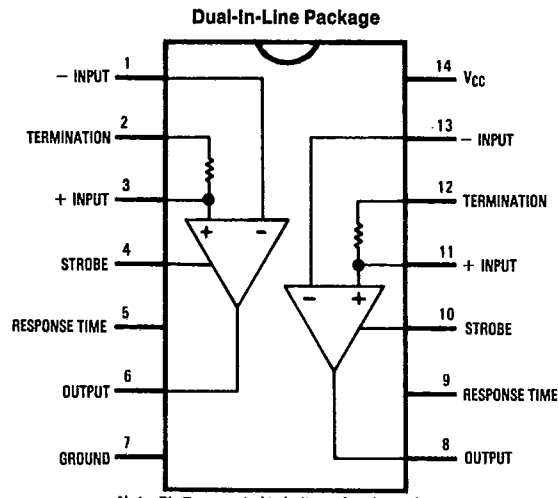

Note: Pin 7 connected to bottom of cavity package.

Top View

TL/F/5797-2

Order Number DS7820AJ, DS8820AJ or DS8820AN
See NS Package Number J14A or N14A

1

DS7820A/DS8820A

Absolute Maximum Ratings (Note 1)

If Military/Aerospace specified devices are required, contact the National Semiconductor Sales Office/Distributors for availability and specifications.

Supply Voltage	8.0V
Common-Mode Voltage	±20V
Differential Input Voltage	±20V
Strobe Voltage	8.0V
Output Sink Current	50 mA
Storage Temperature Range	-65°C to 150°C
Maximum Power Dissipation* at 25°C	
Cavity Package	1308 mW
Molded Package	1207 mW
Lead Temperature (Soldering, 4 sec.)	260°C

*Derate cavity package 8.7 mW/°C above 25°C; derate molded package 9.7 mW/°C above 25°C.

Operating Conditions

T-75-45-07

	Min	Max	Units
Supply Voltage (V _{CC})			
DS7820A	4.5	5.5	V
DS8820A	4.75	5.25	V
Temperature (T _A)			
DS7820A	-55	+125	°C
DS8820A	0	+70	°C

Electrical Characteristics (Notes 2, 3, and 4)

Symbol	Parameter	Conditions	Min	Typ	Max	Units	
V _{TH}	Differential Threshold Voltage	I _{OUT} = -400 μA, V _{OUT} ≥ 2.5V	-3V ≤ V _{CM} ≤ +3V		0.06	0.5	V
			-15V ≤ V _{CM} ≤ +15V		0.06	1.0	V
		I _{OUT} = +16 mA, V _{OUT} ≤ 0.4V	-3V ≤ V _{CM} ≤ +3V		-0.08	-0.5	V
			-15V ≤ V _{CM} ≤ +15V		-0.08	-1.0	V
R _I ⁻	Inverting Input Resistance	-15V ≤ V _{CM} ≤ +15V	3.6	6		kΩ	
R _I ⁺	Non-Inverting Input Resistance	-15V ≤ V _{CM} ≤ +15V	1.8	2.5		kΩ	
R _T	Line Termination Resistance	T _A = 25°C	120	170	250	Ω	
I _I ⁻	Inverting Input Current	V _{CM} = 15V		3.0	4.2	mA	
		V _{CM} = 0V		0	-0.5	mA	
		V _{CM} = -15V		-3.0	-4.2	mA	
I _I ⁺	Non-Inverting Input Current	V _{CM} = 15V		5.0	7.0	mA	
		V _{CM} = 0V		-1.0	-1.6	mA	
		V _{CM} = -15V		-7.0	-9.8	mA	
I _{CC}	Power Supply Current One Side Only	I _{OUT} = Logical "0"	V _{DIFF} = -1V, V _{CM} = 15V		3.9	6.0	mA
			V _{CM} = -15V		9.2	14.0	mA
		V _{DIFF} = -0.5V, V _{CM} = 0V		6.5	10.2	mA	
V _{OH}	Logical "1" Output Voltage	I _{OUT} = -400 μA, V _{DIFF} = 1V	2.5	4.0	5.5	V	
V _{OL}	Logical "0" Output Voltage	I _{OUT} = +16 mA, V _{DIFF} = -1V	0	0.22	0.4	V	
V _{SH}	Logical "1" Strobe Input Voltage	I _{OUT} = +16 mA, V _{OUT} ≤ 0.4V, V _{DIFF} = -3V	2.1			V	
V _{SL}	Logical "0" Strobe Input Voltage	I _{OUT} = -400 μA, V _{OUT} ≥ 2.5V, V _{DIFF} = -3V			0.9	V	
I _{SH}	Logical "1" Strobe Input Current	V _{STROBE} = 5.5V, V _{DIFF} = 3V		0.01	5.0	μA	
I _{SL}	Logical "0" Strobe Input Current	V _{STROBE} = 0.4V, V _{DIFF} = -3V		-1.0	-1.4	mA	
I _{SC}	Output Short Circuit Current	V _O = 0V, V _{CC} = 5.5V, V _{STROBE} = 0V	-2.8	-4.5	-6.7	mA	

Note 1: "Absolute Maximum Ratings" are those values beyond which the safety of the device cannot be guaranteed. Except for "Operating Temperature Range" they are not meant to imply that the devices should be operated at these limits. The table of "Electrical Characteristics" provides conditions for actual device operation.

Note 2: These specifications apply for 4.5V ≤ V_{CC} ≤ 5.5V, -15V ≤ V_{CM} ≤ 15V and -55°C ≤ T_A ≤ +125°C for the DS7820A or 4.75V ≤ V_{CC} ≤ 5.25V, 0°C ≤ T_A ≤ +70°C for the DS8820A unless otherwise specified. Typical values given are for V_{CC} = 5.0V, T_A = 25°C and V_{CM} = 0V unless stated differently.

Note 3: All currents into device pins shown as positive, out of device pins as negative, all voltages referenced to ground unless otherwise noted. All values shown as max or min on absolute value basis.

Note 4: Only one output at a time should be shorted.

Switching Characteristics $T_A = 25^\circ\text{C}$, $V_{CC} = 5\text{V}$, unless otherwise noted **T-75-45-07**

Symbol	Parameter	Conditions	Min	Typ	Max	Units
t_{pd0}	Propagation Delay, Differential Input to "0" Output	$R_L = 400\ \Omega$, $C_L = 15\ \text{pF}$, see Figure 1		30	45	ns
t_{pd1}	Propagation Delay, Differential Input to "1" Output			27	40	ns
t_{pd0}	Propagation Delay, Strobe Input to "0" Output			16	25	ns
t_{pd1}	Propagation Delay, Strobe Input to "1" Output			18	30	ns

AC Test Circuit and Waveforms

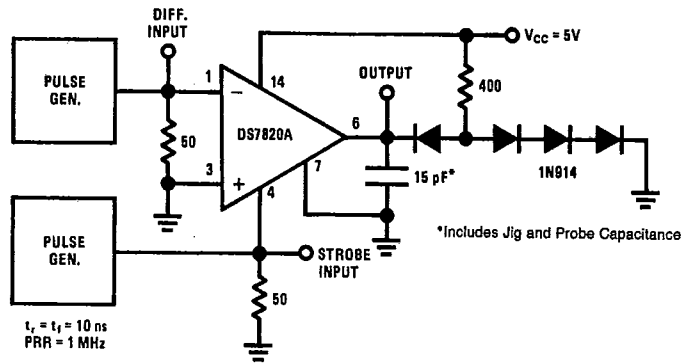

TL/F/5797-7

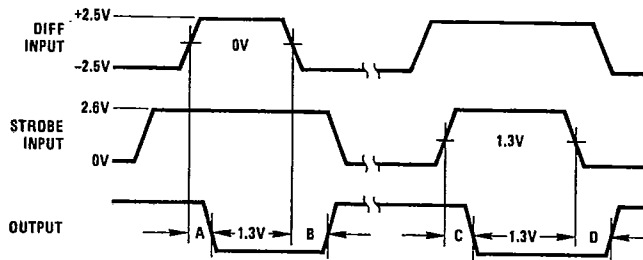

TL/F/5797-8

- A = Differential Input to "0" Output
- B = Differential Input to "1" Output
- C = Strobe Input to "0" Output
- D = Strobe Input to "1" Output

FIGURE 1

Typical Performance Characteristics (Note 3)

T-75-45-07

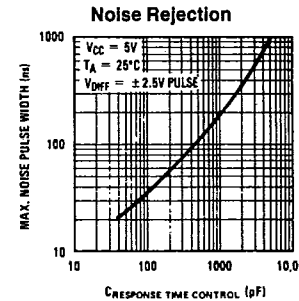
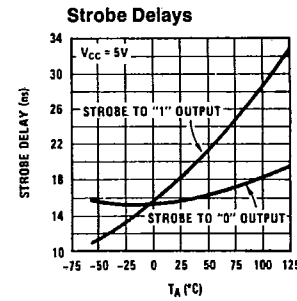
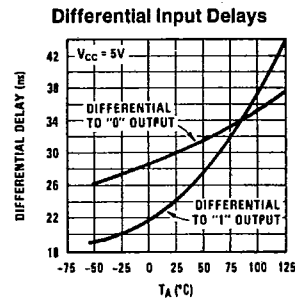
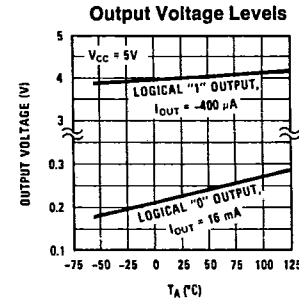
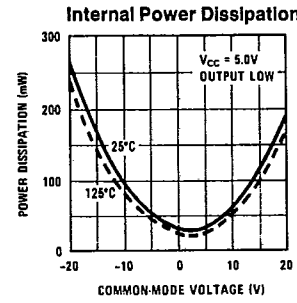
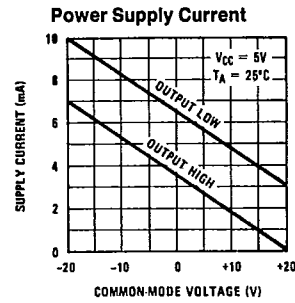
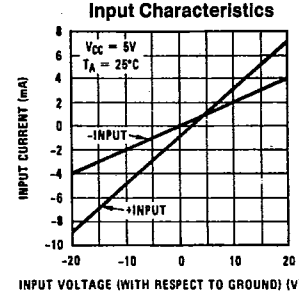
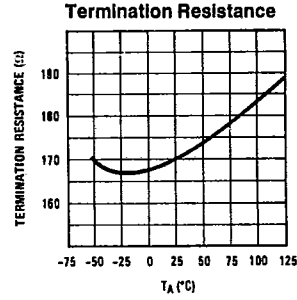
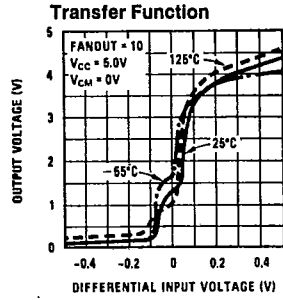
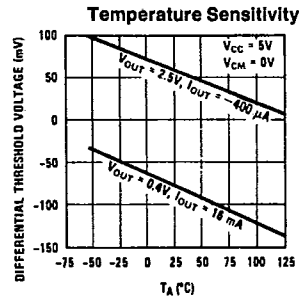
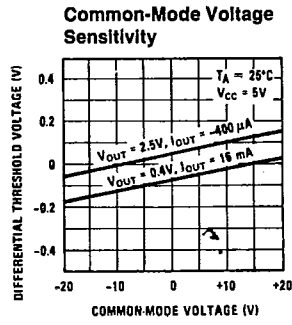
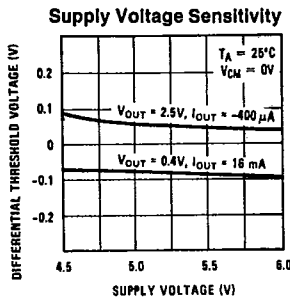

TL/F/5797-6

Schematic Diagram

T-75-45-07

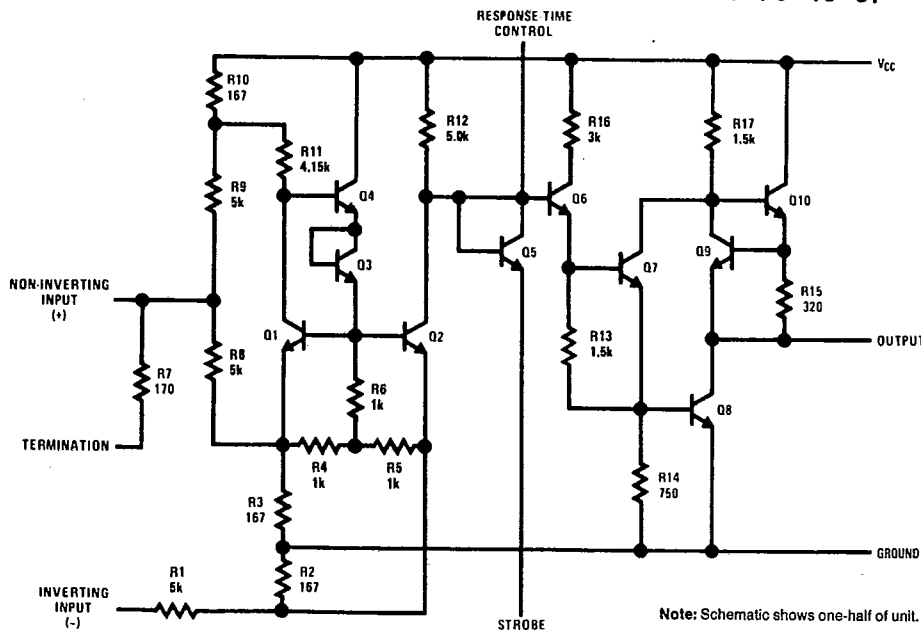

TL/F/5797-1

Typical Applications

Differential Line Driver and Receiver

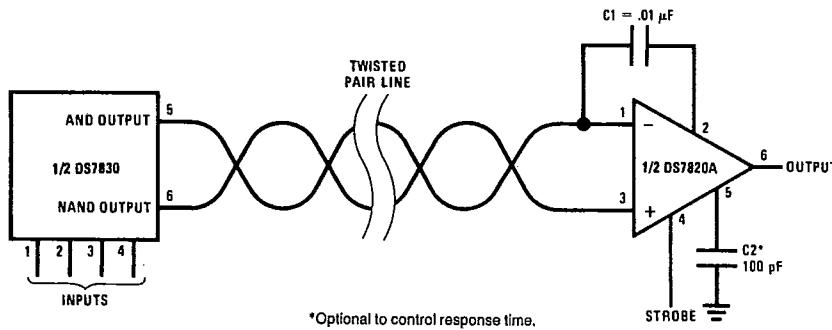

*Optional to control response time.

TL/F/5797-3

Single Ended (EIA-RS232C) Receiver with Hysteresis

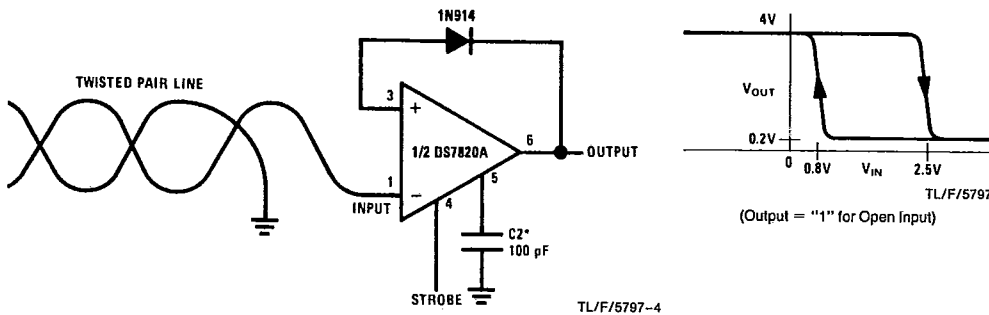

TL/F/5797-4

TL/F/5797-5

(Output = "1" for Open Input)