

## AB2726B 27mm Piezoelectric Bender

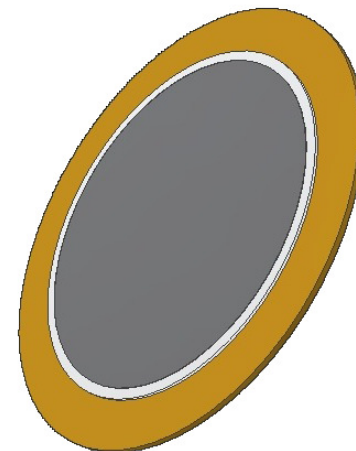

3541 Stop Eight Road • Dayton, Ohio 45414

### Product Overview

- 27mm diameter ceramic piezo bender with 2,600 Hz resonant frequency
- Reliable, 0.26mm thin, and lightweight
- Very low current consumption for use in portable devices
- Designed to be driven with direct TTL or CMOS signals up to 30Vp-p

Used in smoke detectors



RoHS Compliant



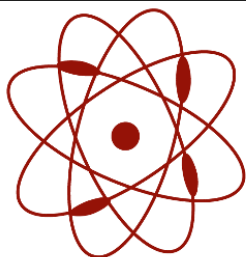

**pui**  
**audio**™ inc  
a projects unlimited company

## AB2726B 27mm Piezoelectric Bender

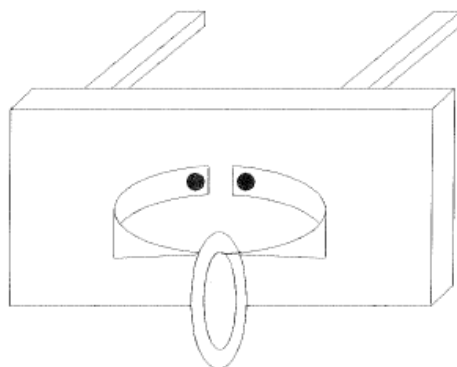

The piezo ceramic diaphragm shall be clamped at a nodal point as shown in the figure above and be free from any mechanical stress. The resonant frequency and resonant impedance is measured using sine sweep analysis. The resonant frequency is defined where the impedance shows minimum value; this shall also be the resonant impedance.

Capacitance is measured at 120 Hz using an LCR meter such as a Hewlett Packard HP49194A.

### Nodal Mounting



Mounting typically occurs at 60% of the overall diameter of the piezo bender's brass or steel plate. Usually the same diameter as the piezo ceramic element.

Higher output than Edge Mounting with reduced frequency response bandwidth (i.e. single tone).

### Edge Mounting



Mounting typically occurs at 1mm inside the outside edge of the bender's brass or steel plate.

Wider frequency response than Nodal Mounting while sacrificing maximum output.

# SPECIFICATIONS

PARAMETERS	VALUES	UNITS
RESONANT FREQUENCY	2,600 ± 500	Hz
RESONANT IMPEDANCE (MAX)	250	Ohm
MAX INPUT VOLTAGE	30	Vp-p
CAPACITANCE @ 1kHz	50,000 ±30%	pF
PLATE MATERIAL	BRASS	-
OPERATING TEMPERATURE	-20 ~ +60	°C
STORAGE TEMPERATURE	-20 ~ +70	°C

THIS DOCUMENT CONTAINS DATA PROPRIETARY TO PROJECTS UNLIMITED, INC. ANY USE OR REPRODUCTION, IN ANY FORM, WITHOUT PRIOR WRITTEN PERMISSION OF PROJECTS UNLIMITED, INC. IS PROHIBITED.  
©2003, Projects Unlimited Inc.

# REVISION HISTORY

LTR	DESCRIPTION	DATE	APPROVED
-	RELEASED FROM ENGINEERING	2/11/2004	
A	REVISED DIMENSION SIZE AND STYLE	1/24/2006	B.R.
B	REVISED TO INVENTOR 3-D DRAWING TEMPLATE	8/13/2010	B.R.

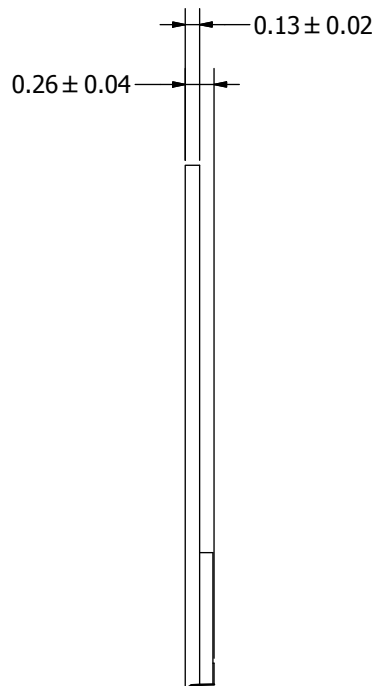
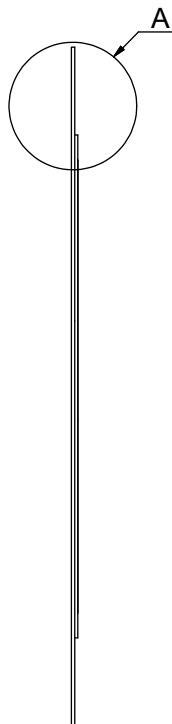
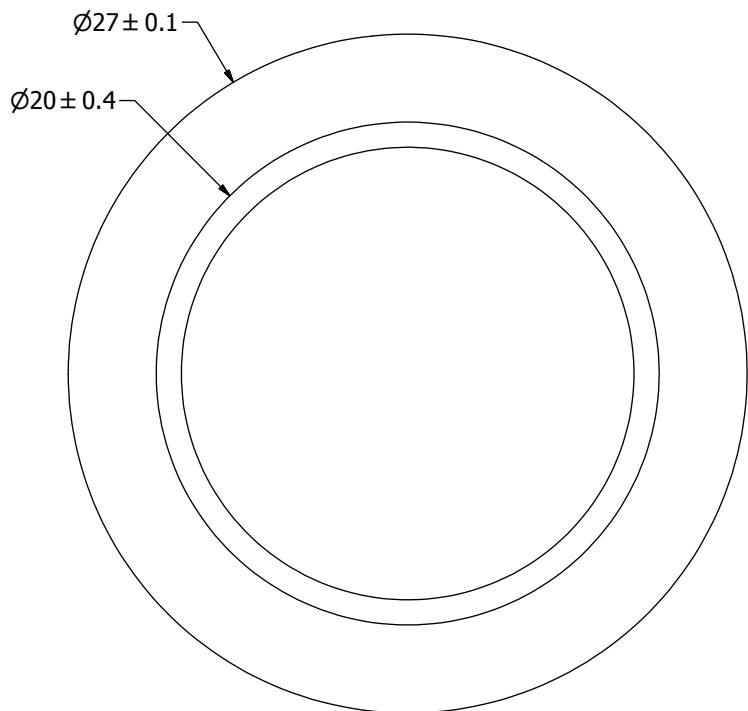

A ( 22 : 1 )

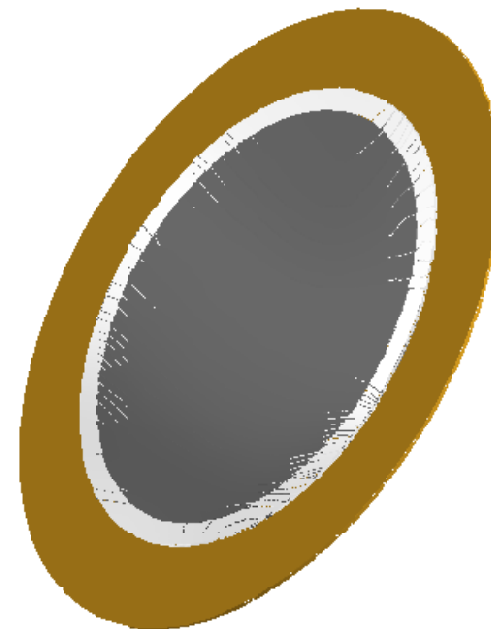

### NOTES:

1. ALL DIMENSIONS ARE IN MILLIMETERS.
2. SPECIFICATIONS SUBJECT TO CHANGE OR WITHDRAWAL WITHOUT NOTICE.
3. THIS PART IS RoHS 2002/95/EC COMPLIANT.

UNLESS OTHERWISE SPECIFIED: DIMENSIONS ARE IN MILLIMETERS, TOLERANCES ARE ±0.5 AND ANGLES ARE ±3°.	SIZE	Designed by	Date	Checked by	Date	Approved by	Date	Drawn Date
	A3	R.A.C.	2/11/2004			R.W.	2/12/2004	8/13/2010
AB2726B.idw			<b>AB2726B</b>					
			Bender			Edition		Sheet
						-		1 / 1