

PRODUCT NUMBER SEE SHEET 2

A

B

C

D

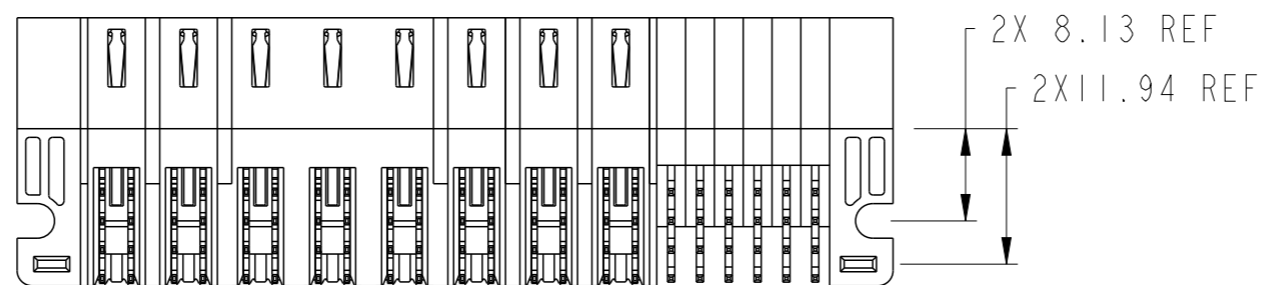
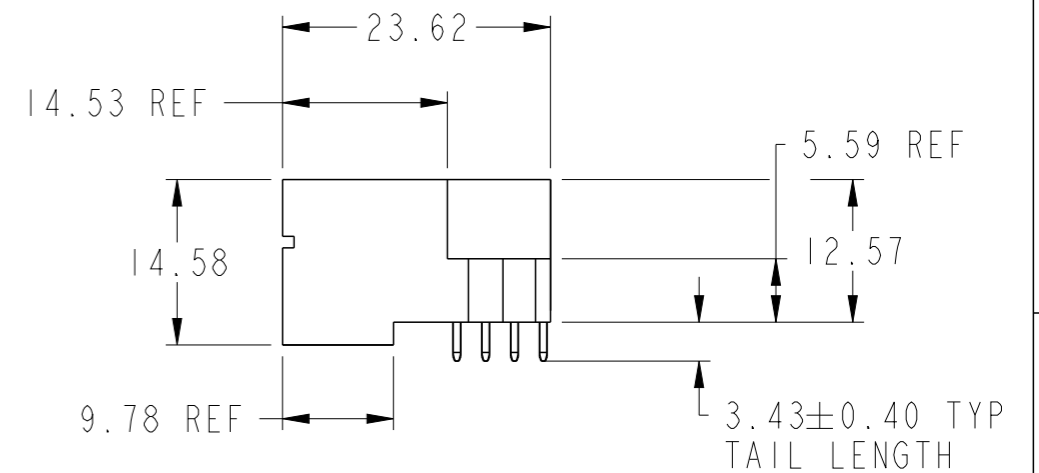
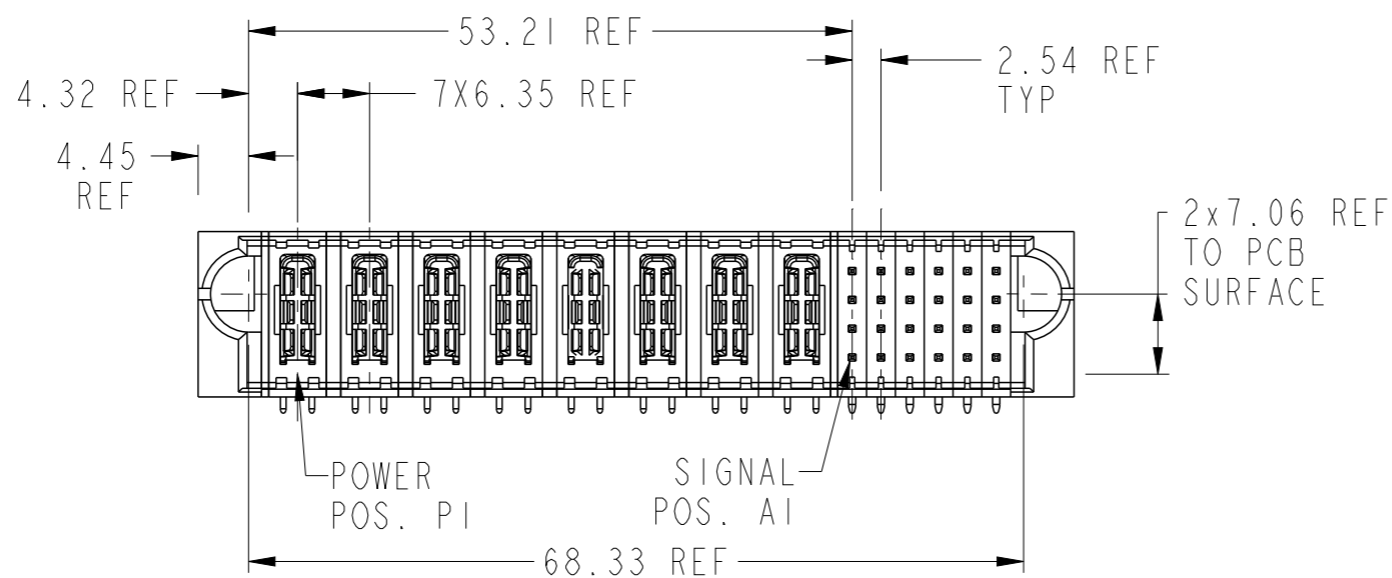
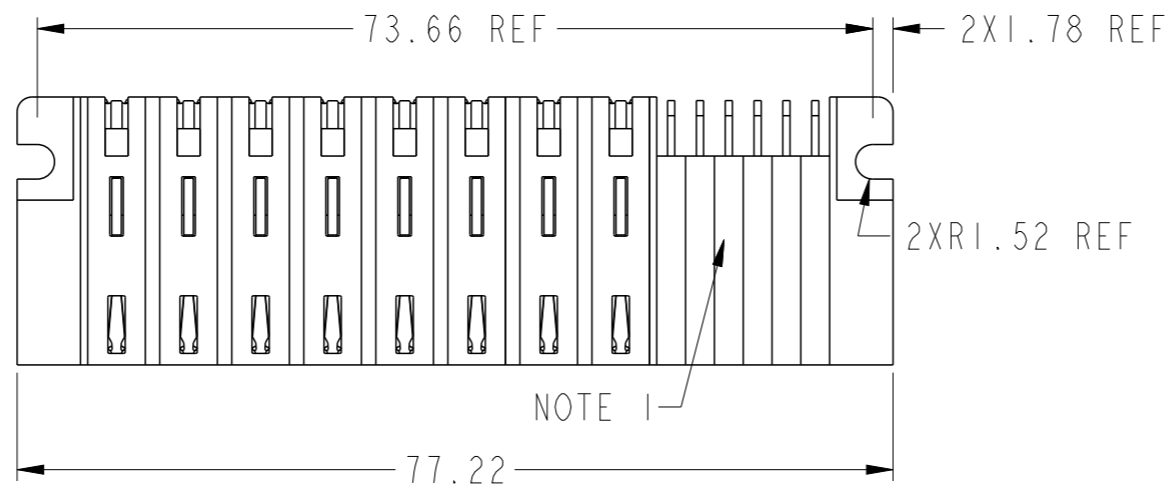

Copyright FCI.

spec ref	*	dr	Eddy Zeng	2013/11/11	projection	MM	size	A3	scale	3:2
tolerance std	ASME Y14.5	eng	Eddy Zeng	2013/11/19			ecn no	-	rel level	Released
TOLERANCES UNLESS OTHERWISE SPECIFIED		chr	Li-He	2013/11/19						
surface	<input checked="" type="checkbox"/> linear <input type="checkbox"/> angular	0.X ±0.5 0.XX ±0.25 0.XXX ±0.10			8HP + 24S RA STB HEADER		dwg no 10106124-8006002	rev A		
ASME Y14.5	angular	0° ±2°	www.fci.com	cat. no.	Product - Customer Drw			sheet 1 of 3		

PRODUCT NO. 10106124-8006002LF	ROWS DCBA	HIGH POWER								SIGNAL					
		E1	P1	P2	P3	P4	P5	P6	P7	P8	1	2	3	4	5

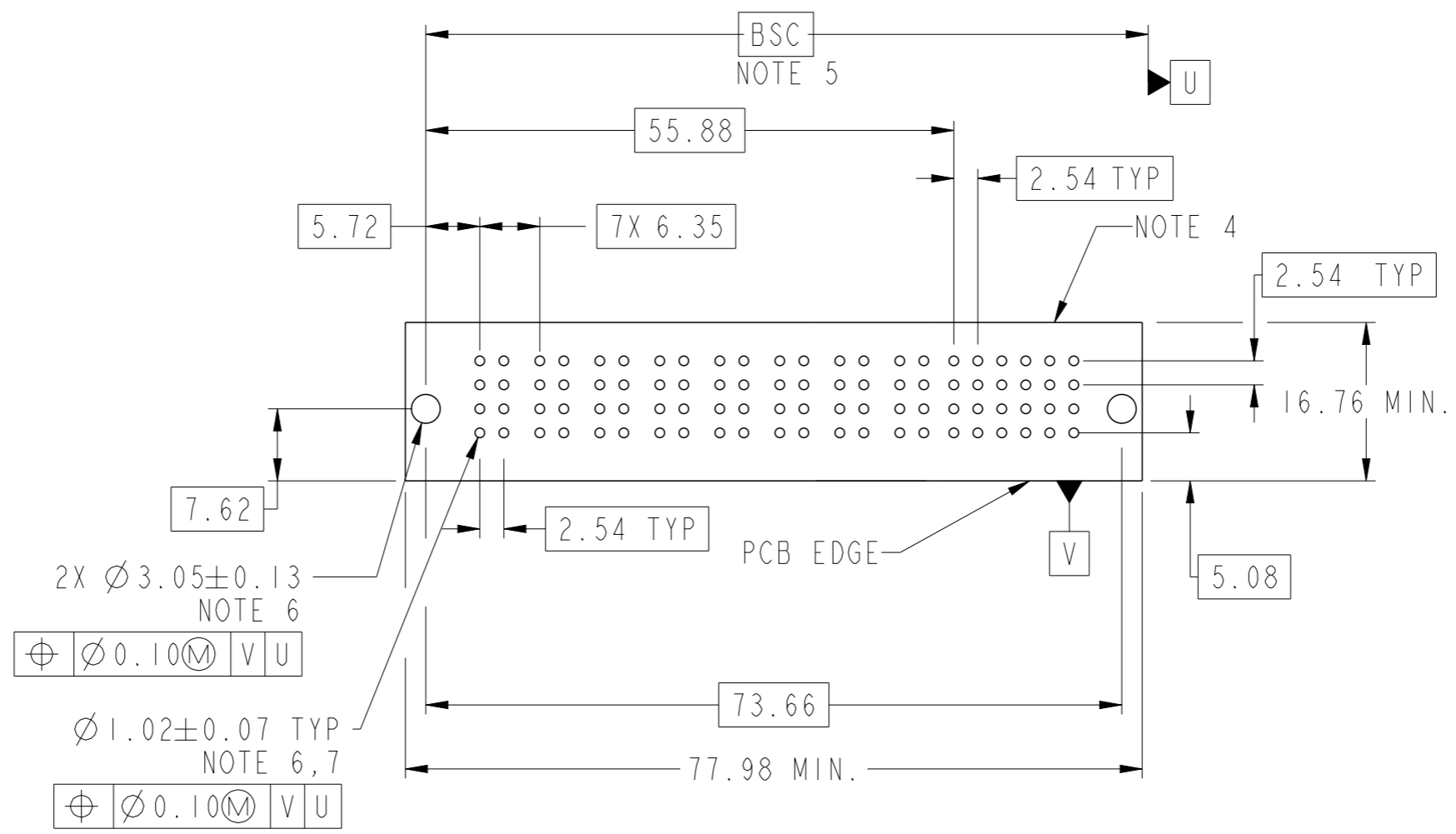
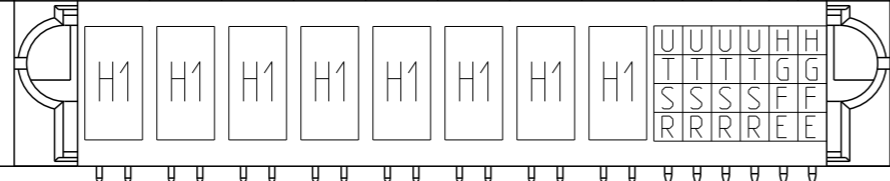

2X $\varnothing 3.05 \pm 0.13$
NOTE 6
 $\varnothing 0.10$ (M) V U
 $\varnothing 1.02 \pm 0.07$ TYP
NOTE 6,7
 $\varnothing 0.10$ (M) V U

CODE	DESCRIPTION
E	MLBF SIGNAL CONTACT, ROW A (3.43)
F	MLBF SIGNAL CONTACT, ROW B (3.43)
G	MLBF SIGNAL CONTACT, ROW C (3.43)
H	MLBF SIGNAL CONTACT, ROW D (3.43)
HI	STD HIGH POWER CONTACT (3.43)
R	STD SIGNAL CONTACT, ROW A (3.43)
S	STD SIGNAL CONTACT, ROW B (3.43)
T	STD SIGNAL CONTACT, ROW C (3.43)
U	STD SIGNAL CONTACT, ROW D (3.43)

dr	Eddy Zeng	2013/11/11	projection	MM	size	A3	scale	3:2
eng	Eddy Zeng	2013/11/19			ecn no		-	
chr	Li-He	2013/11/19			rel level		Released	
appr	Pei-Ming Zheng	2013/11/19	product family		PwrBlade+		-	
			title 8HP + 24S RA STB HEADER			dwg no 10106124-8006002		rev A
www.fci.com			cat. no.		Product - Customer Drw			sheet 2 of 3





Copyright FCI.

NOTES:

- 1) "FCI", PART NUMBER AND DATE CODE TO BE MARKED ON THIS SURFACE.
THE MARK CAN BE OMITTED IF THERE IS NOT ENOUGH SPACE ON THIS SURFACE.
- 2) MATERIALS:
-HOUSING - GLASS FILLED WITH HIGH TEMP THERMOPLASTIC, UL94V-0.
-SIGNAL CONTACT - COPPER ALLOY.
-POWER CONTACT - HIGH CONDUCTIVITY COPPER ALLOY.
- 3) PLATING SPECIFICATION REFER TO FCI 10116351
- 4) DENOTES CONNECTOR KEEP OUT ZONE.
- 5) DATUM AND BASIC DIMENSIONS WERE ESTABLISHED BY CUSTOMER.
- 6) ALL HOLE DIAMETERS ARE FINISHED HOLE SIZES.
- 7) 1.15 ± 0.025 MM DRILLED HOLE PLATED WITH 0.00762MM MIN Sn
OVER 0.0254-0.0762MM Cu PLATING TO ACHIEVE A 1.02 ± 0.07 MM HOLE.
- 8) PRODUCT SPECIFICATION REFER TO FCI GS-12-658.
APPLICATION SPECIFICATION REFER TO FCI GS-20-141.
PRODUCT PACKAGED IN TRAYS, REFER TO FCI GS-14-1502.

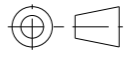
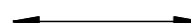

Copyright FCI.

dr	Eddy Zeng	2013/11/11	projection 	MM 	size	A3	scale	3:2
eng	Eddy Zeng	2013/11/19			ecn no	-		
chr	Li-He	2013/11/19			rel level	Released		
appr	Pei-Ming Zheng	2013/11/19	product family	PwrBlade+				
		8HP + 24S RA STB HEADER		dwg no 10106124-8006002	rev A			
www.fci.com		cat. no.	Product - Customer Drw		sheet 3 of 3			