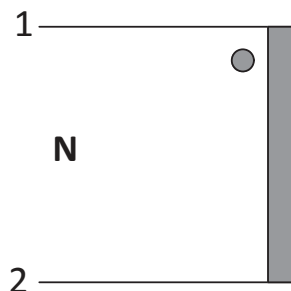
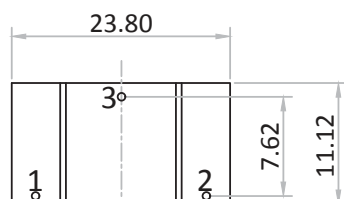
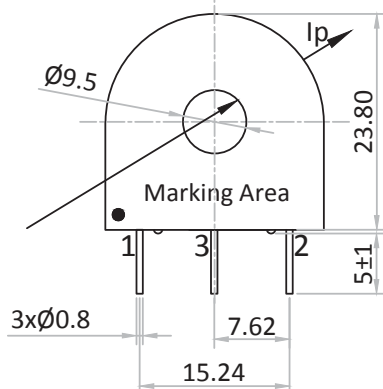

Product Type	Current Transformer	
Amgis Part Number	CCX-1050	

SCHEMATIC:ELECTRICAL SPECIFICATION:

Rated input current	= 50Amps
Accuracy	= Class 1
Operating Frequency	= 50 / 60 Hz
Turns Ratio	= 1 : 2500
DC Resistance	= 157 Ω
Primary to Secondary Isolation	= 4000VAC
Operating Temperature	= -40°C to +85°C
Output Voltage	= 0.66V \pm 1% @ 33 Ω

MECHANICAL SPECIFICATION:Pin Side View:Front View:

Note : Pin#3 → Un-used Pin

All dimensions are in mm
 Linear dimensional tolerance
 \pm 0.2mm

MARKING INFORMATION:

AMGIS
 CCX-1050 ww/yy code

TRAFOWEIGHT:

Approx. Weight = 0.031 kg / pc

OUTPUT RESPONSE vs INPUT CURRENT @ RATED BURDEN:

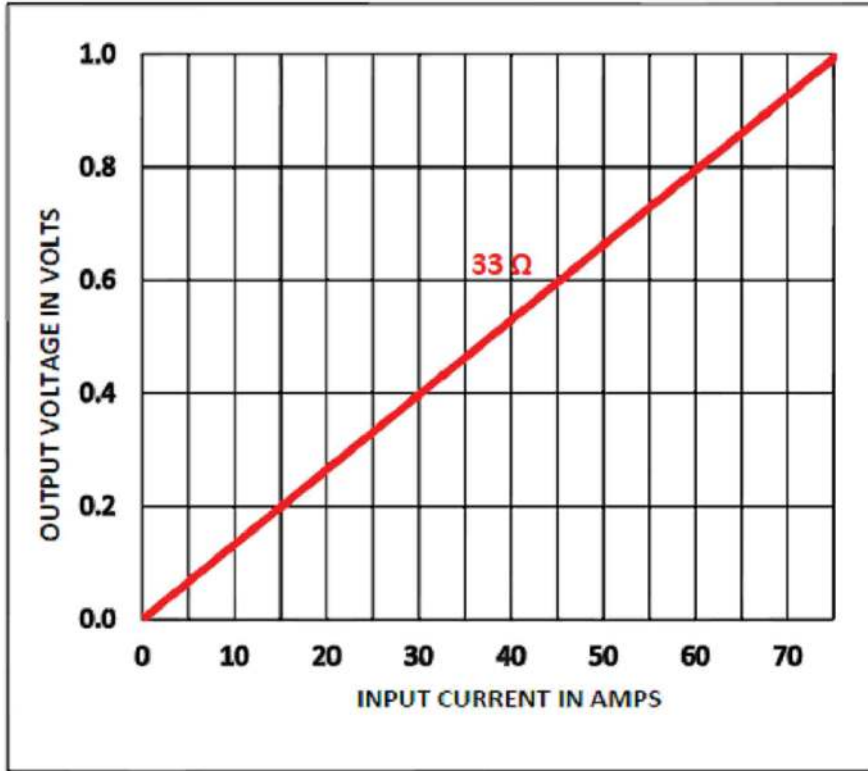

RATIO ERROR vs INPUT CURRENT @ RATED BURDEN:

%RE VS RL AT RATED PRIMARY CURRENT @50A/50HZ

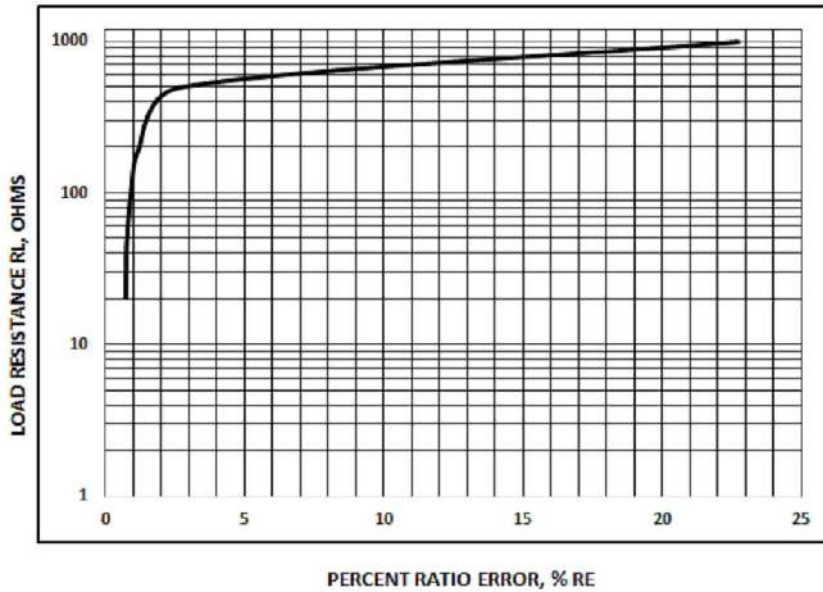

-----Initial Issue-----	1	000	Perumal.M	J. Castro	06-02-2018
Changes	Issue	Rel	Prepared	Reviewed	Date