

Specification of Temperature Probe

PART NUMBER: TT4-PT100B-T200-1500

No. of pages: 1

Date: **24.09.2015**

Revision: **00**

FEATURES:

Sensing Element	PT100
Class according to EN 60751	B
Temperature Coefficient	TCR = 3850 ppm/k
Operating temperature range	-40°C ÷ 200°C
Test Voltage	1000V DC
International Protection Rating	IP 67
RoHS Compatible	YES

DRAWING:

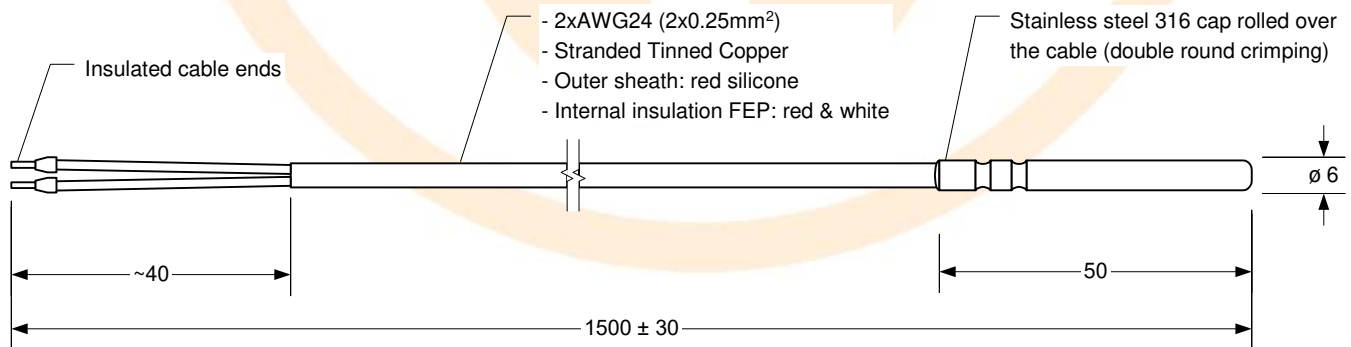

UNITS: [mm]