

# PhlatLight™ SBT16 Projection Chipset

## Technology Overview

Luminus Devices' Projection Technology (PT) is an innovative solid-state light source created to replace arc lamps in projection systems, enabling a new category of lamp-free projectors. Enabled by unique use of Photonic Lattice technology, PhlatLight chipsets represent a major breakthrough in brightness that delivers all the benefits of solid state light sources in projections applications:

- Wide color gamut for vivid colors, exceeds NTSC.
- Environmentally friendly technology - Mercury-free.
- Instant start and re-start - no more wait time.
- High reliability; no more lamp replacement.
- Electronic control of color points and light intensity on a frame by frame basis

PhlatLight products benefit from numerous innovations in the domain of packaging, thermal management and optical coupling that allow designers to achieve efficient light engine designs and deliver high screen brightness.

### Angular Intensity Distribution -Example

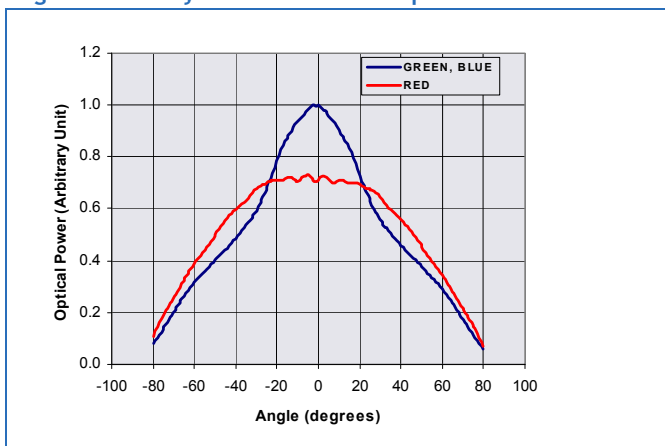

## Features

- Matched RGB Chipset with 1.6mm<sup>2</sup> emitting area designed for small, pico projector and “value” pocket projector applications
- Photonic lattice technology for very high surface brightness
- Wide color gamut: RED 623 nm, GREEN 525 nm, BLUE 460 nm typical dominant wavelength
- Single emitting area per color allows for collection with single lens for simplified optics
- 16:10 aspect ratio optimized for WVGA, WXGA or other wide aspect ratio micro-displays
- Uniform surface emission
- Compact, small footprint surface mount (SMT) package, with built-in alignment features
- RoHS compliant (EU-2002/95/EC Directive)

## Applications

- Large dynamic range allows optimum performance in both battery-powered and AC powered systems
- Optimized for Micro-Display diagonal sizes ranging from 0.2” to 0.4”.
- Compatible with all micro-display technologies including DLP™ and LCoS.

### SBT-16 Ordering Part Numbers

Ordering Part Number <sup>1</sup>	Color	Min Flux or Power Bin <sup>2</sup>	Availability	Description
SBT-16-R-J11-MPB	Red	1A	Now	Red Bin Kit, PhlatLight SBT16 surface mount device consisting of a 1.6mm <sup>2</sup> LED, mounted on a ceramic substrate.
SBT-16-R-J11-MPC		1B	Now	
SBT-16-G-J11-MPA	Green	1A	Now	Green Bin Kit, PhlatLight SBT16 surface mount device consisting of a 1.6mm <sup>2</sup> LED, mounted on a ceramic substrate
SBT-16-G-J11-MPB		1B	Now	
SBT-16-G-J11-MPC		1C	Now	
SBT-16-G-J11-MPD		1D	Now	
SBT-16-B-J11-EPA	Blue	1A	Now	Blue Bin Kit, PhlatLight SBT16 surface mount device consisting of a 1.6mm <sup>2</sup> LED, mounted on a ceramic substrate
SBT-16-B-J11-EPB		1B	Now	

Note 1: Ordering part numbers represent bin kits (group of bins that are shippable for a given ordering part number)  
 Note 2: See Bin Kit and Flux / Power bin definitions on page 3

### PhlatLight Ordering Part Number Nomenclature

SBT	-	NN	-	X	-	J11	-	XYZ	-	TR <sup>1</sup>
Product Family		Chip Area		Color		Package Configuration		Bin Kit <sup>2</sup>		Packaging Option
SBT: Surface mount SBR: SBT device soldered to a starboard		16: 1.6mm <sup>2</sup>		R=Red G=Green B=Blue		J11: 9.0mm X 7.25mm		See page 3 for Bin Kit definition		TR= tape & reel blank=tray/pack

Note 1: For Tape and Reel Packaging option, please add -TR to end of ordering part number. E.g. SBT-16-R-J11-MPB-TR  
 Note 2: A Bin Kit represents a group of individual flux or power bins that are shippable for a given ordering part number. In order to ensure availability, individual flux or power bins are not orderable.

**EXAMPLES:**

SBT-16-R-J11-MPB is comprised of Red Flux Bins 1A, 1B, 1C and 1D (Packaging option: trays / packs)  
 SBT-16-R-J11-MPB-TR is comprised of Red Flux Bins 1A, 1B, 1C and 1D (Packaging option: tape and reel)  
 SBR-16-R-J11-MPB is SBT-16 Red device soldered to a starboard (see p.10). Note: Available in sample quantities only for prototyping.

## SBT-16 Bin Kit<sup>1</sup> and Flux / Power Bin<sup>2,3,4</sup> Definitions

Note: Please refer to ordering part number table on page 2 for Bin Kit availability

Red Flux Bins	Bin 1A	Bin 1B	Bin 1C	Bin 1D	Bin 1E	Bin 1F	Bin 1G	Bin 1H	Bin 1J
Red Bin Flux Range (lm)	155-180	180-215	215-245	245-275	275-300	300-330	330-360	nd	nd
SBT-16-R-J11-MPB	<input checked="" type="checkbox"/>	<input checked="" type="checkbox"/>	<input checked="" type="checkbox"/>	<input checked="" type="checkbox"/>					
SBT-16-R-J11-MPC		<input checked="" type="checkbox"/>	<input checked="" type="checkbox"/>	<input checked="" type="checkbox"/>	<input checked="" type="checkbox"/>				
Green Flux Bins	Bin 1A	Bin 1B	Bin 1C	Bin 1D	Bin 1E	Bin 1F	Bin 1G	Bin 1H	Bin 1J
Green Bin Flux Range (lm)	315-355	355-395	395-430	430-470	470-510	510-550	550-600	600-660	660-725
SBT-16-G-J11-MPA	<input checked="" type="checkbox"/>	<input checked="" type="checkbox"/>	<input checked="" type="checkbox"/>	<input checked="" type="checkbox"/>					
SBT-16-G-J11-MPB		<input checked="" type="checkbox"/>	<input checked="" type="checkbox"/>	<input checked="" type="checkbox"/>	<input checked="" type="checkbox"/>				
SBT-16-G-J11-MPC			<input checked="" type="checkbox"/>	<input checked="" type="checkbox"/>	<input checked="" type="checkbox"/>	<input checked="" type="checkbox"/>			
SBT-16-G-J11-MPD				<input checked="" type="checkbox"/>	<input checked="" type="checkbox"/>	<input checked="" type="checkbox"/>	<input checked="" type="checkbox"/>		
Blue Power Bins	Bin 1A	Bin 1B	Bin 1C	Bin 1D	Bin 1E	Bin 1F	Bin 1G	Bin 1H	Bin 1J
Blue Bin Power Range (W)	1.54-1.75	1.75-1.95	1.95-2.10	2.10-2.30	2.30-2.50	2.50-2.75	2.75-3.00	3.00-3.30	nd
SBT-16-B-J11-EPA	<input checked="" type="checkbox"/>	<input checked="" type="checkbox"/>	<input checked="" type="checkbox"/>	<input checked="" type="checkbox"/>	<input checked="" type="checkbox"/>				
SBT-16-B-J11-EPB		<input checked="" type="checkbox"/>	<input checked="" type="checkbox"/>	<input checked="" type="checkbox"/>	<input checked="" type="checkbox"/>	<input checked="" type="checkbox"/>			

Note 1: Bin Kits are defined by a group of flux or power bins. Only one flux bin will be shipped in each individual pack or reel. A shipment will contain packs or reels of different allowed flux or power bins for a particular ordering part number. In order to ensure availability, individual Flux or Power bins are not orderable.

Note 2: Luminus maintains a tolerance of +/-6% on flux and power measurements

Note 3: SBT-16 LEDs are tested for luminous flux and radiometric at 4A, single pulse (20mS) and placed into one of the above flux or power bins. Flux and power bins have been defined, but not all defined bins are currently populated.

Note 4: Flux bin limits for Red and Green and power bin limits for Blue devices apply across the entire dominant wavelength range for each color. (See dominant wavelength range for each color on page 4)

## Optical and Electrical Characteristics

		Symbol	Red	Green	Blue	Unit
Emitting Area			1.6	1.6	1.6	mm <sup>2</sup>
Emitting Area Dimensions			1.6x1.0	1.6x1.0	1.6x1.0	mmxmm
<b>Characteristics at Test Drive Current, <math>I_F</math><sup>1</sup></b>						
Test Peak Drive Current <sup>1</sup>	typ	$I_F$	4.0	4.0	4.0	A
Peak Luminous Flux <sup>1,2,3</sup>	typ	$\Phi_v$	220	470	90	lm
Radiometric Flux <sup>1, 2, 3</sup>	typ	$\Phi_r$	1.3	1.0	2.0	W
Dominant Wavelength <sup>1</sup>	min	$\lambda_{dmin}$	619	516	450	nm
	typ	$\lambda_d$	623	525	460	nm
	max	$\lambda_{dmax}$	630	535	468	nm
FWHM - Spectral bandwidth at 50% of $\Phi_v$	typ	$\Delta\lambda_d$	18	40	20	nm
Chromaticity Coordinates <sup>4,5</sup>	typ	x	0.699	0.162	0.149	
	typ	y	0.301	0.711	0.031	
Forward Voltage	min	$V_{Fmin}$	2.0	3.9	3.2	V
	typ	$V_F$	2.4	4.9	3.9	V
	max	$V_{Fmax}$	3.2	5.9	5.2	V
Dynamic Resistance	typ	$\Omega_{dyn}$	0.08	0.09	0.07	$\Omega$
<b>Characteristics at Pulsed Drive Current, <math>I_F</math> (for information only)<sup>6</sup></b>						
Reference Duty Cycle			25	50	25	%
Reference Peak Drive Current	typ	$I_F$	4.0	4.0	4.0	A
Peak Luminous Flux <sup>2</sup>	typ		215	400	80	lm
<b>Device Thermal Characteristics</b>						
Thermal Coefficient of Photometric Flux	typ		-1.1	-0.2	-0	% / °C
Thermal Coefficient of Radiometric Flux	typ		-0.6	-0.3	-0.1	% / °C
Forward Voltage Temperature Coefficient	typ		-3	-8	-4	mV / °C

Note 1: Test conditions: 4A, single pulse, 20ms, test temperature not controlled.

Note 2: Total flux from emitting area

Note 3: Luminous maintains a tolerance of +/-6% on flux and power measurements

Note 4: In CIE 1931 chromaticity diagram coordinates, normalized to X+Y+Z=1

Note 5: For reference only

Note 6: Typical performance based on SBT-16 mounted on Al coreboard. Operation at 720Hz, 4A, pulsed at the specified duty cycles and at constant heat sink temperature  $T_{hs} = 40^\circ\text{C}$ . ( See Thermal Resistance section for  $T_{hs}$  definition.)

## Absolute Maximum Ratings

		Symbol	Red	Green	EP-Blue	Unit
Minimum Current (CW or Pulsed) <sup>1</sup>	Min		200	200	200	mA
Maximum Current (CW) <sup>2</sup>	Max		2.4	2.4	2.4	A
Maximum Current (pulsed) <sup>1,3</sup> ( $t \leq 2.5\text{ms}$ , frequency > 240Hz, duty cycle < 60%)			4.8	4.8	4.8	A
Absolute Maximum Junction Temperature <sup>4</sup>	Max	$T_{jmax}$	110	150	150	°C
Storage Temperature Range			-40/+100	-40/+100	-40/+100	°C

Note 1: Product performance and lifetime data is specified at recommended forward drive currents. Sustained operation at or near absolute minimum currents may result in a reduction of device performance and device lifetime compared to recommended forward drive currents.

Note 2: Luminus PhlatLight LEDs are designed for operation to an absolute maximum forward drive current density of 1.5A/mm<sup>2</sup> cw, and 3.0A/mm<sup>2</sup> pulsed ( $f > 240\text{Hz}$ , duty cycle < 60%). Please refer to absolute maximum rating table above for specific absolute maximum currents for the products covered in this datasheet.

Product lifetime data is specified at recommended forward drive currents. Sustained operation at absolute maximum currents will result in a reduction of device lifetime compared to recommended forward drive currents. Actual device lifetimes will also depend on junction temperature. Refer to the lifetime derating curves for further information.

Note 3: In pulsed operation, rise time from 10 to 90% of forward current should be larger than 0.5 microseconds.

Note 4: Sustained operation at or above the Absolute Maximum Junction Temperature ( $T_{jmax}$ ) will result in reduced device life time.

**Luminous Flux variation with Wavelength:  $\Phi_v = f(\lambda_d)$  at Test Drive Current  $I_F$**

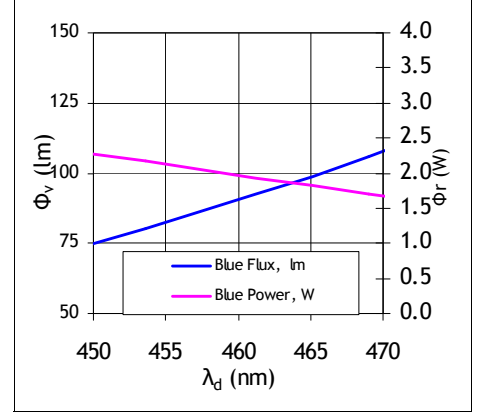
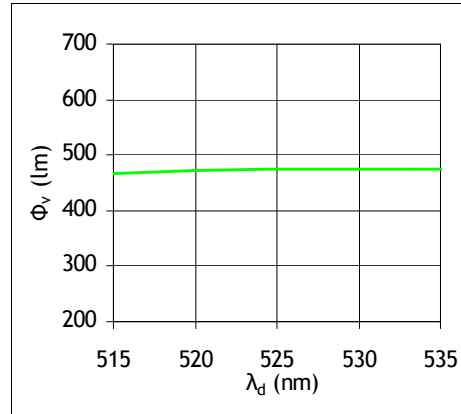
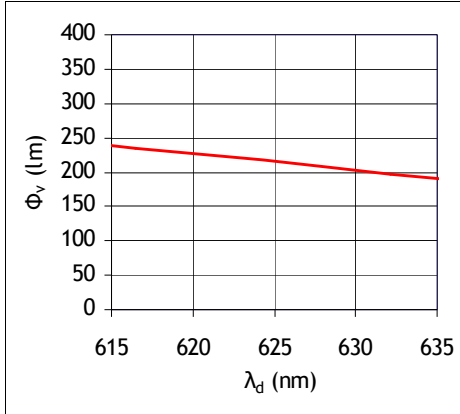

See note 1,3 on page 7.

**Luminous Flux variation with Drive Current -  $\Phi_v = f(I_F)$  - Typical**

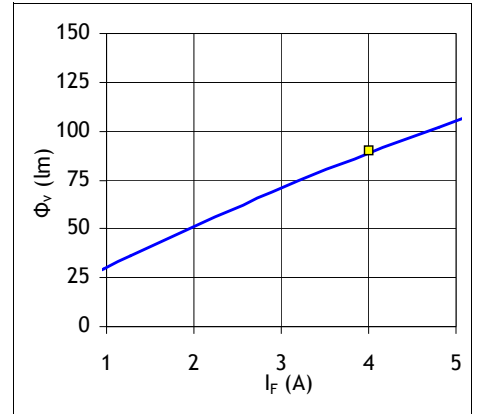
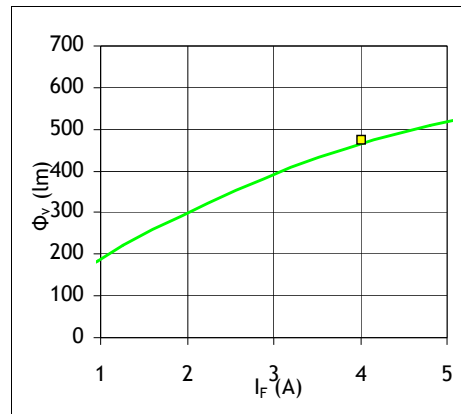
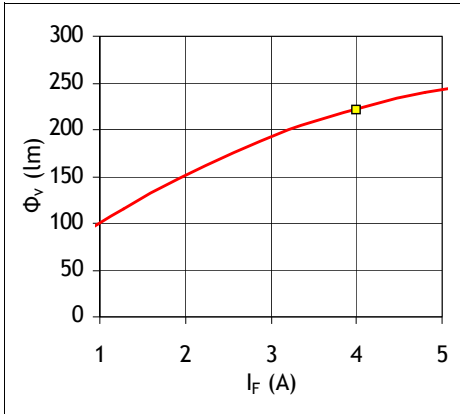

See notes 1, 2, 3 on page 7.

**Dominant Wavelength variation with Forward Current -  $\lambda_d = f(I_F)$  - Typical**

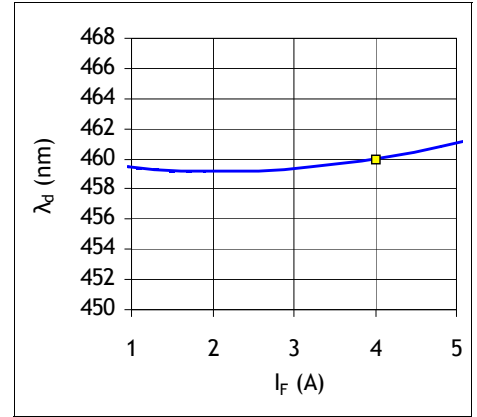
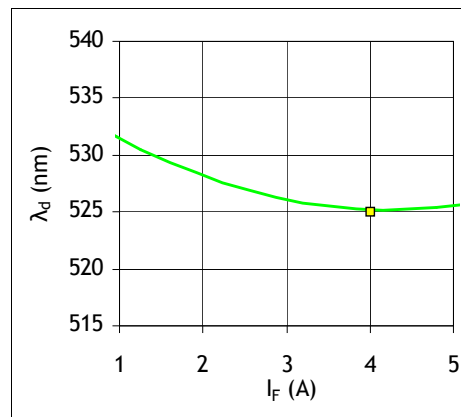
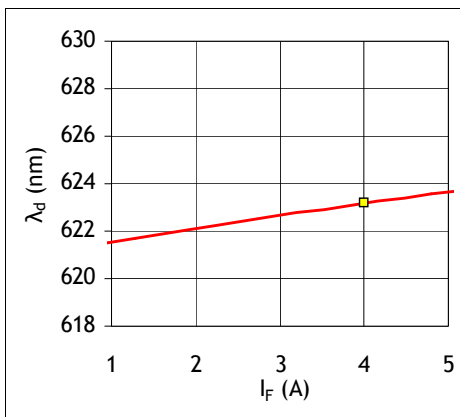

See notes 1, 2 on page 7.

**Forward Voltage variation with Drive current -  $V_F = f(I_F)$  - Typical**

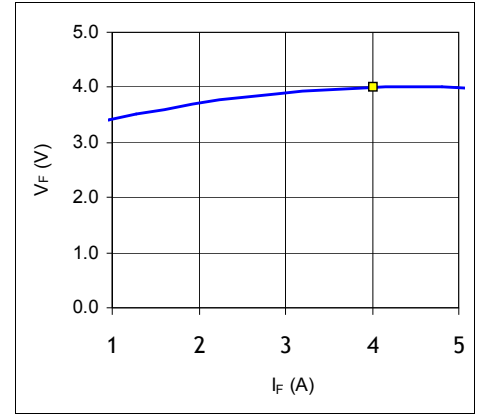
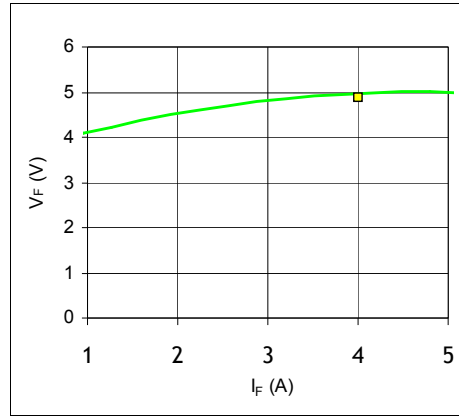
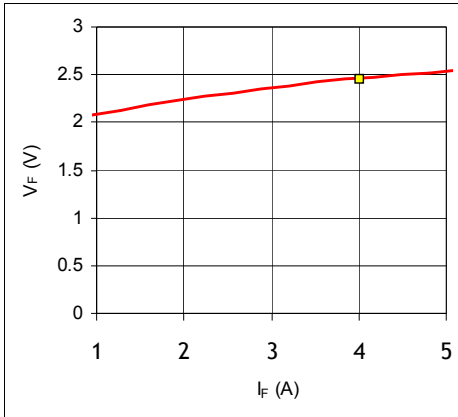

See notes 1,2 on page 7.

**Optical Spectrum (Typical)**

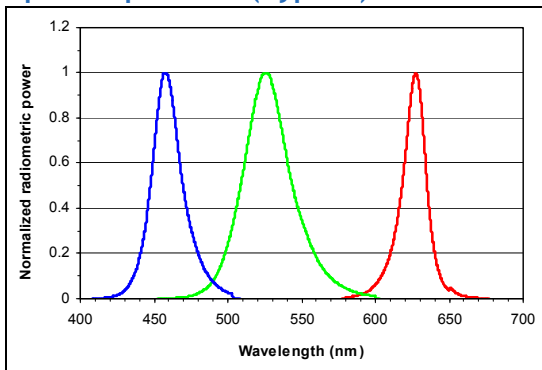

See note 4 on page 7.

**Chart Notes**

- Note 1: Test conditions: single pulse , 20mS, test temperature not controlled. Data below 1.5A is extrapolated.
- Note 2: Yellow square indicate device operating point under test conditions: 4A, single 20mS pulse, test temperature not controlled.
- Note 3: Luminus maintains a tolerance of +/-6% on flux and power measurements.
- Note 4: Typical Spectrum at recommended peak drive current.

## Thermal Resistance

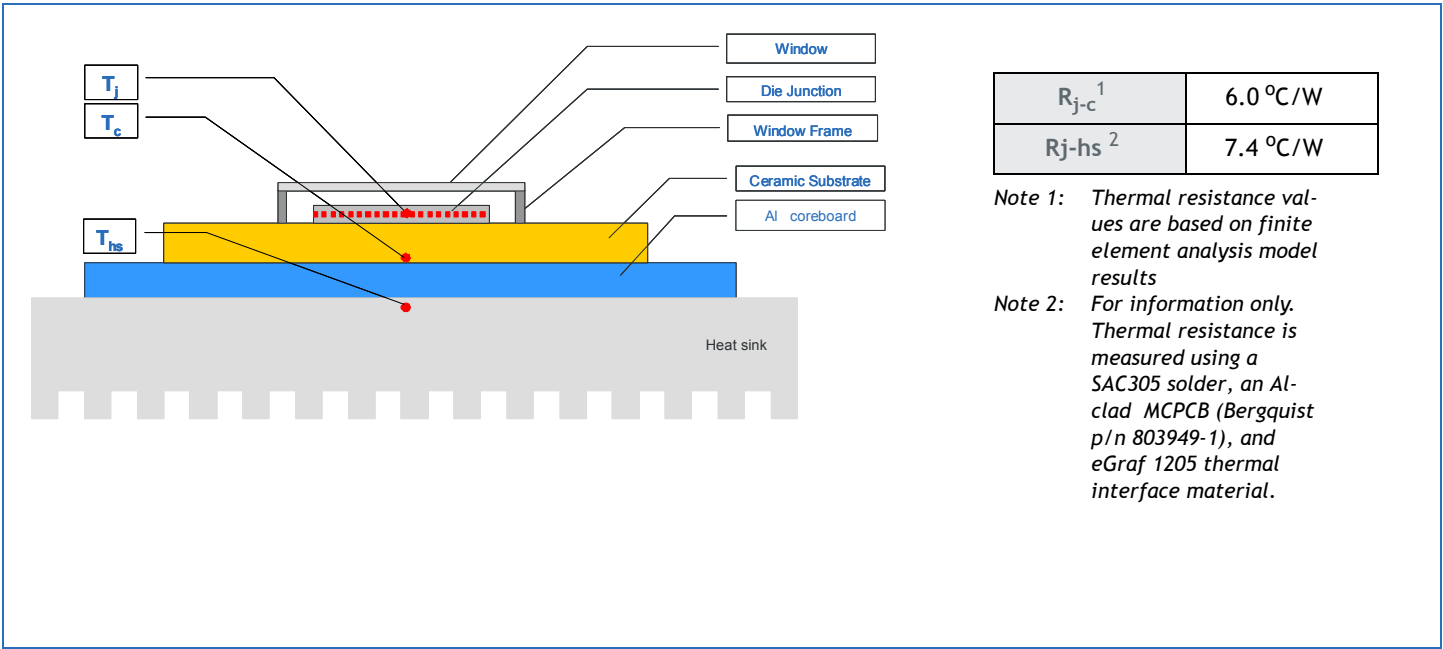



Mechanical Dimensions

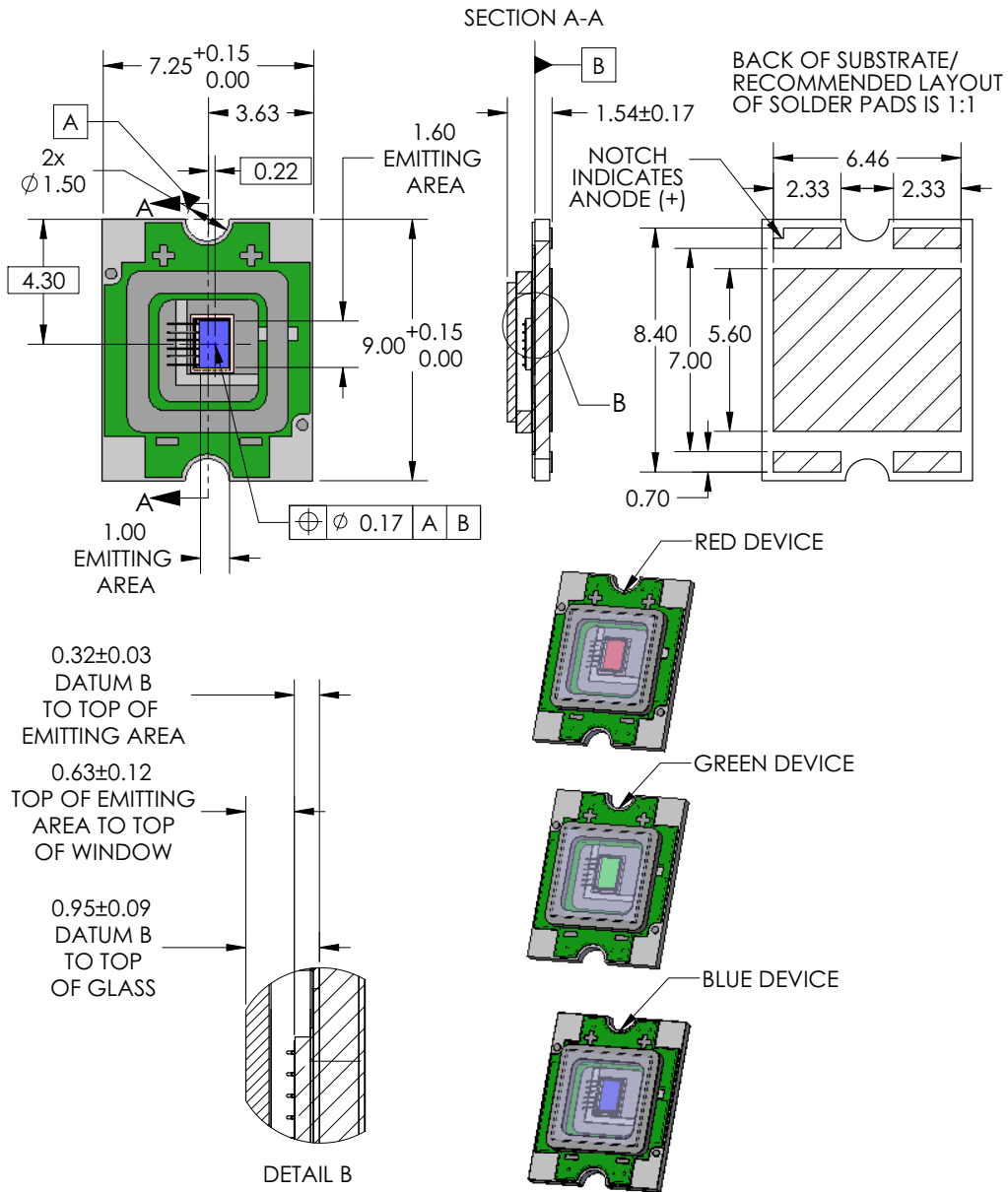

- Red, Green and Blue SBT16 PhlatLight™ LEDs are individually assembled into a SMT Board with a footprint of 9.0 mm x 7.25 mm.

Dimension above for information only. For detailed dimensions, always refer to the latest revision of the DWG-1493 package outline

Mechanical Dimensions - SBT-16 Star

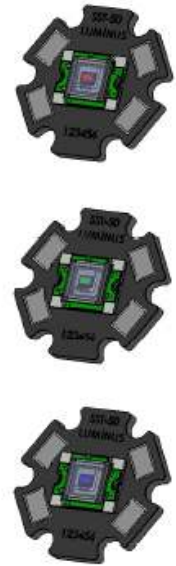
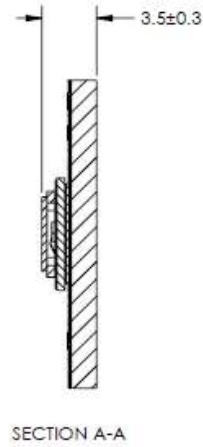
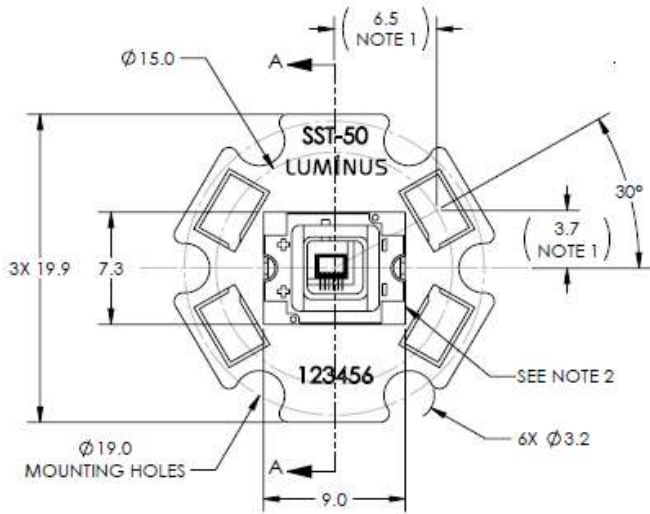

Notes:

1. Tolerances per IPC-610, Class 2.
2. For detail drawing of SBT-16, please see DWG 1493.
3. Recommended mounting screw: M3 or #4
4. All dimensions in millimeters
5. All anode pads on board are interconnected. All cathode pads on board are interconnected

## Reflow Soldering Characteristics

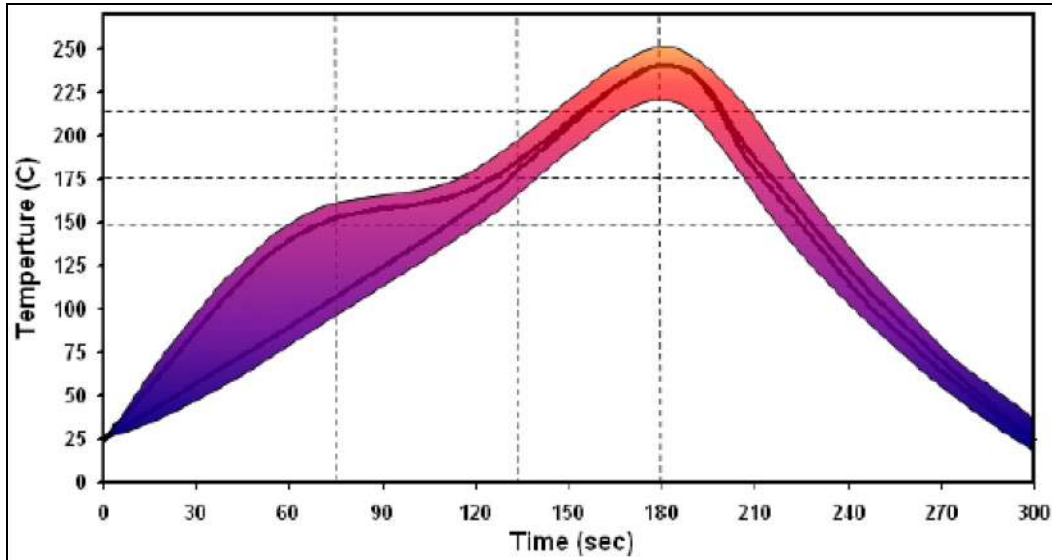

## Solder profile guideline

Solder Profile Stage	Lead-free solder	Lead-based solder
Profile Length, Ambient to Peak	2.75 - 3.5 minutes	2.75 - 3.5 minutes
Time Maintained Above: Temperature	217 °C	183 °C
Time Maintained Above: Time	30 - 60 seconds	30-60 seconds
Cooldown Rate	≤ 4° C/sec	≤ 4° C/sec
Cooldown Duration	45 ± 15 sec	45 ± 15 sec

- Note: 1. Temperatures are taken and monitored at the component copper layer
- Note: 2. Optimum profile may differ due to oven type, circuit board or assembly layout
- Note: 3. Recommended lead free, no-clean solder: AIM NC254-SAC305
- Note: 4. Refer to APN-001473: PhlatLight Soldering and Handling application note for additional solder profiles and details.

### Shipping Tray Outline

For detailed drawing of shipping tray, please refer to TO-0977 and TO-0978 document (available from Luminus)

DIMENSIONS IN MILLIMETERS

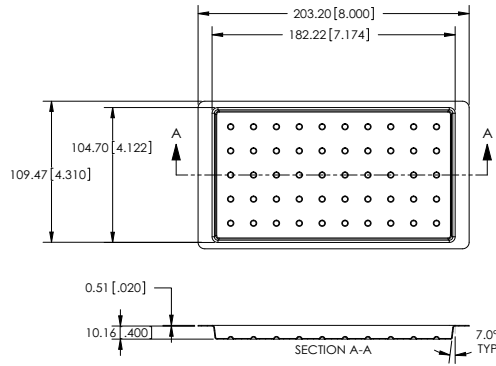

DIMENSIONS IN MILLIMETERS

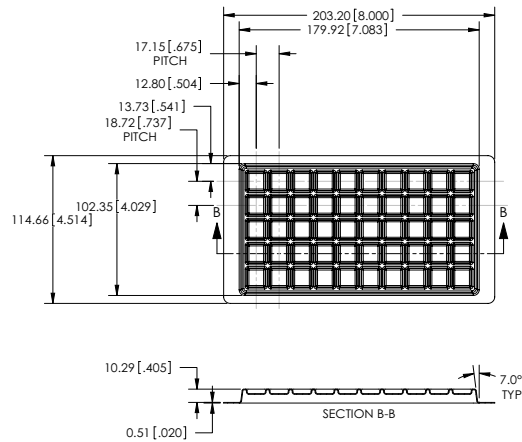

## Tray Packing Configuration

### Pack

Packing Case	Qty/Pack	Dimensions (WxLxH, mm)	Gross Weight (g)
Pack	100	120 x 200 x 15	101

(Stack of 2 Trays with 50 devices each)  
(Pack is enclosed in moisture barrier bag)

### Labeling Specification (example)

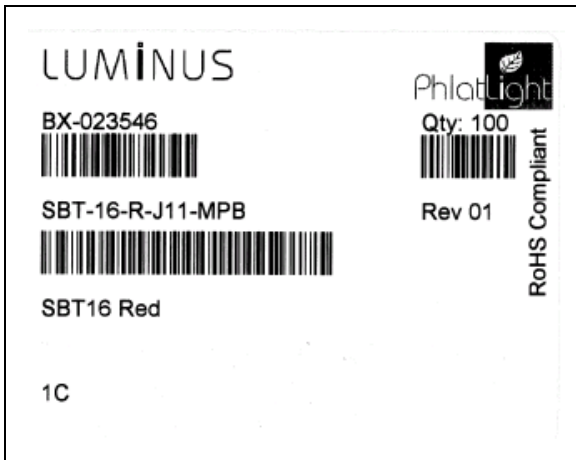

#### Pack Label Fields:

(Label fields are subject to change)

- 6-digitPackNumber:  
(Luminus Internal Use )
- Luminus Ordering Part Number
- Luminus\_Product\_Description:  
(Device Type and Color)
- Quantity of devices in the pack
- Part Number Revision:  
(Luminus Internal Use)
- Optional Fields may include Customer's Part Number



Sample labels - For illustration only

## Tape and Reel Outline

For detailed drawing of Tape and Reel, please refer to TO-1000 (available from Luminus)

DIMENSIONS ARE IN mm. (INCH)

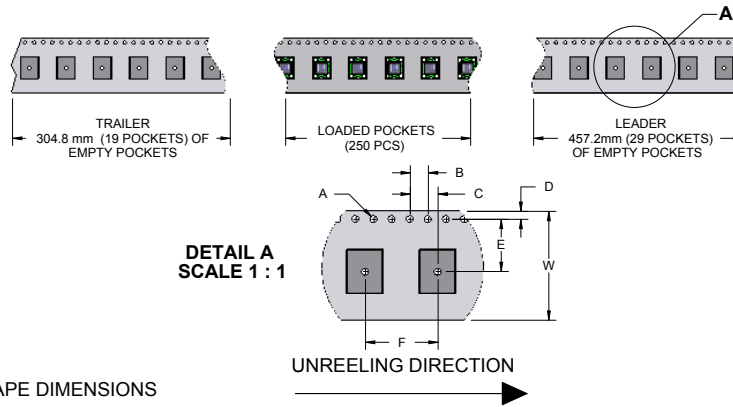

TAPE DIMENSIONS

W	A	B	C	D	E	F
24.0 (.945)	∅ 1.5 (.059)	3.9 (.157)	6.1 (.241)	1.7 (.069)	11.5 (.453)	16.0 (.630)

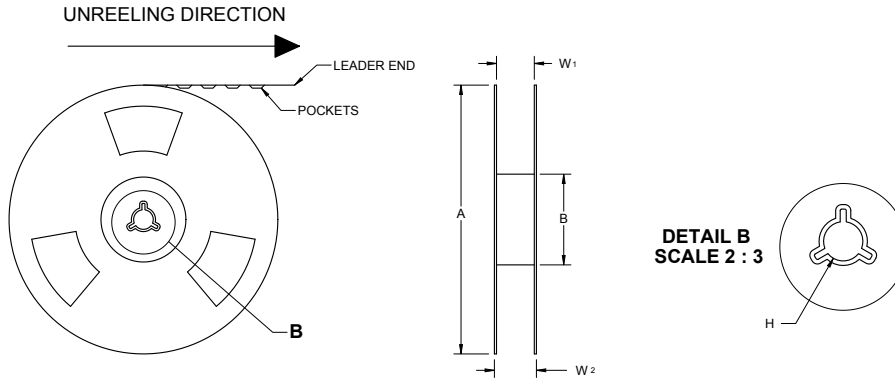

REEL DIMENSIONS

A	W <sub>1</sub>	W <sub>2</sub>	B	H
∅ 180 (7)	25 (.984)	27.8 (1.094)	60.0 (2.362)	∅ 13.0 (.512)

## Packing Configuration

### Tape and Reel

Packing Reel	Qty/Reel	Reel Diameter (mm)	Gross Weight (kg)
Tape and Reel	250	180	TBA

(Reel is enclosed in moisture barrier bag)

### Labeling Specification (TBD)

Sample label - Illustration

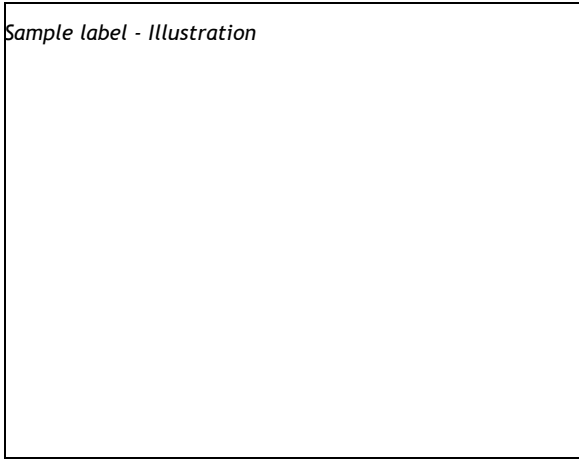

#### Tape and Reel Label Fields:

(Label fields are subject to change)

- 6-digit BX-Number:(Luminus Internal Use )
- Luminus Ordering Part Number
- Flux Bin
- Quantity of devices in the pack
- Optional Fields may include Customer's Part Number

Sample labels - For illustration only

## History of Changes

Rev	Date	Description of Change
Rev 01	3/19/10	Preliminary Specifications
Rev 02	6/25/10	Add preliminary specifications for Green LED Binkit C Update Max Junction Temperature for Green and Blue devices Update Tray packing specifications
Rev 03	11/08/10	Add Bin Kit and Bin definitions (p.3) Add ordering part number information
Rev 04	04/12/11 5/17/11	Add additional Bin Kit definitions Update luminous flux and optical power specifications per test calibration update Add preliminary Tape and Reel packaging specifications Correct typographical error on p.2

The products, their specifications and other information appearing in this document are subject to change by Luminus Devices without notice. Luminus Devices assumes no liability for errors that may appear in this document, and no liability otherwise arising from the application or use of the product or information contained herein. None of the information provided herein should be considered to be a representation of the fitness or suitability of the product for any particular application or as any other form of warranty. Luminus Devices' product warranties are limited to only such warranties as accompany a purchase contract or purchase order for such products. Nothing herein is to be construed as constituting an additional warranty. No information contained in this publication may be considered as a waiver by Luminus Devices of any intellectual property rights that Luminus Devices may have in such information. PhlatLight™ is a registered trademark of Luminus Devices, Inc., all rights reserved.

This product is protected by U.S. Patents 6,831,302; 7,074,631; 7,083,993; 7,084,434; 7,098,589; 7,105,861; 7,138,666; 7,166,870; 7,166,871; 7,170,100; 7,196,354; 7,211,831; 7,262,550; 7,274,043; 7,301,271; 7,341,880; 7,344,903; 7,345,416; 7,348,603; 7,388,233; 7,391,059; 7,417,367 Patents Pending in the U.S. and other countries.

[www.luminus.com](http://www.luminus.com)