

Xinger[®] IV

Ultra Low Profile 0805 3dB Hybrid Coupler

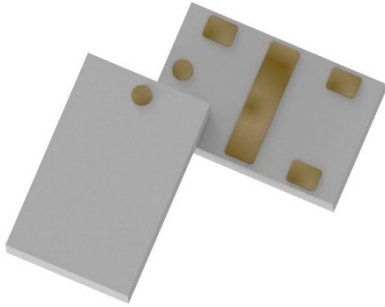

Description

The X4C20J1-03G is a low profile, high performance 3dB hybrid coupler in a new easy to use, manufacturing friendly surface mount package. It is designed for 5G applications. The X4C20J1-03G is available on tape and reel for pick and place high volume manufacturing.

All of the Xinger components are constructed from ceramic filled PTFE composites, which possess excellent electrical and mechanical stability. All parts have been subjected to rigorous qualification testing and units are 100% RF tested. Produced in an ENIG final finish.

Detailed Electrical Specifications

Features:	Frequency	Isolation	Insertion Loss	Return Loss	Amplitude Balance
	<i>MHz</i>	<i>dB Min</i>	<i>dB Max</i>	<i>dB Min</i>	<i>dB Max</i>
<ul style="list-style-type: none"> • 1700-2300 MHz • 5G Applications • Very Low Loss • Tight Amplitude Balance • High Isolation • Production Friendly • Tape and Reel 	1700-2300	20	0.5	20	± 0.5
	Phase	Group Delay	Power	Operating Temp.	
	<i>Degrees</i>	<i>Max nS</i>	<i>Avg. CW Watts @105C</i>	<i>°C</i>	
	90 ± 4	TBD	5	-55 to +140	

*Specifications subject to change without notice. Refer to parameter definitions for details.

**Specification based on performance of unit properly installed on TTM Technologies Test Board with small signal applied.

Outline Drawing

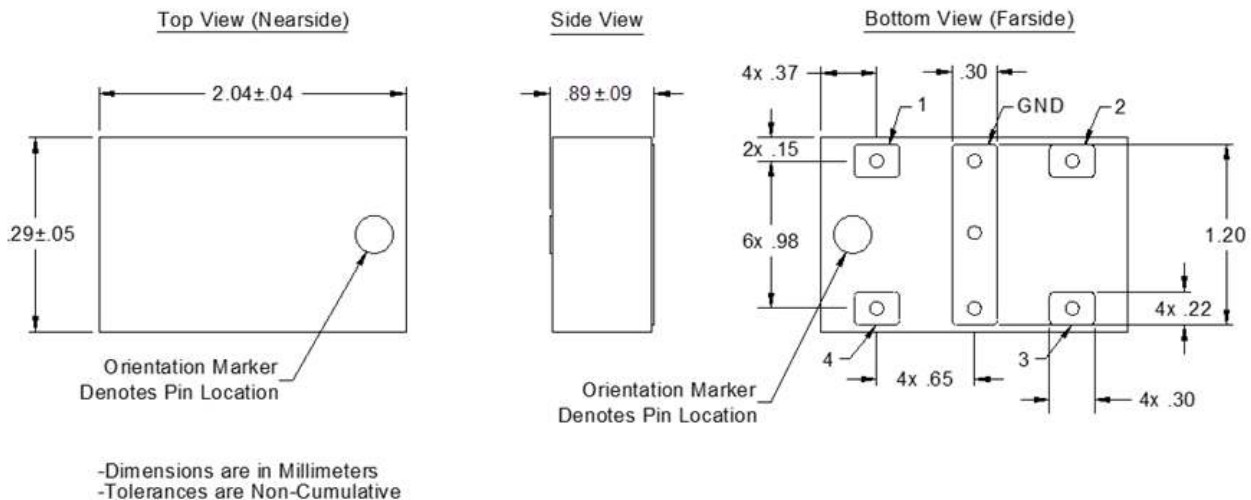

Hybrid Coupler Pin Configuration

The X4C20J1-03G has an orientation marker to denote Pin 1. Once port one has been identified the other ports are known automatically. Please see the chart below for clarification:

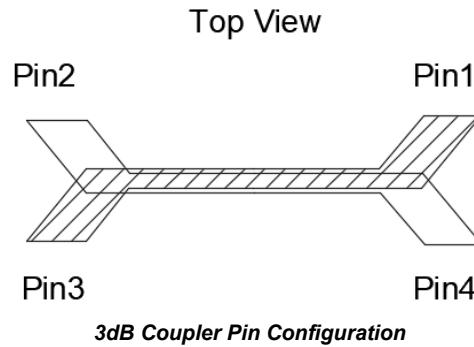

Configuration	Pin 1	Pin 2	Pin 3	Pin 4
Splitter	Input	Isolated	$-3\text{dB } \angle\theta - 90$	$-3\text{dB } \angle\theta$
Splitter	Isolated	Input	$-3\text{dB } \angle\theta$	$-3\text{dB } \angle\theta - 90$
Splitter	$-3\text{dB } \angle\theta - 90$	$-3\text{dB } \angle\theta$	Input	Isolated
Splitter	$-3\text{dB } \angle\theta$	$-3\text{dB } \angle\theta - 90$	Isolated	Input
*Combiner	$A \angle\theta - 90$	$A \angle\theta$	Isolated	Output
*Combiner	$A \angle\theta$	$A \angle\theta - 90$	Output	Isolated
*Combiner	Isolated	Output	$A \angle\theta - 90$	$A \angle\theta$
*Combiner	Output	Isolated	$A \angle\theta$	$A \angle\theta - 90$

Note: The direct port has a DC connection to the input port and the coupled port has a DC connection to the isolated port. For optimum IL and power handling performance, use Pin 1 or Pin 3 as inputs.

Peak Power Handling

High-Pot testing of these couplers during the qualification procedure resulted in a minimum breakdown voltage of 1Kv (minimum recorded value). This voltage level corresponds to a breakdown resistance capable of handling at least 12dB peaks over average power levels, for very short durations. The breakdown location consistently occurred across the pads and the ground bar (see illustration below). The breakdown levels at these points will be affected by any contamination in the gap area around these pads. These areas must be kept clean for optimum performance. It is recommended that the user test for voltage breakdown under the maximum operating conditions and over worst case modulation induced power peaking. This evaluation should also include extreme environmental conditions (such as high humidity).

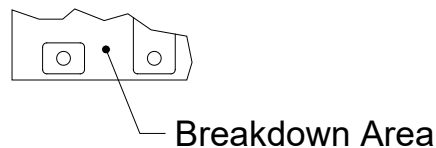

Insertion Loss and Power Derating Curves

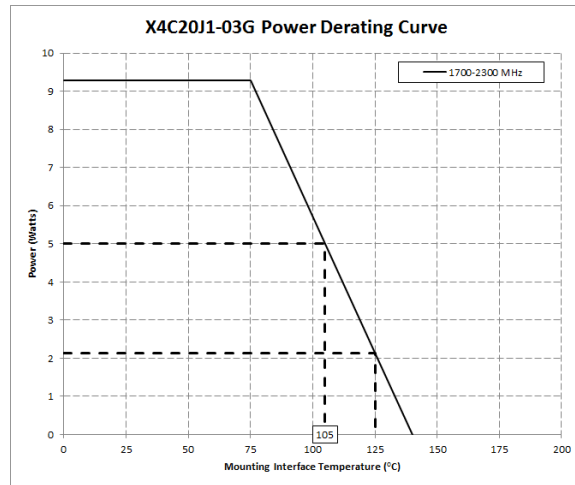
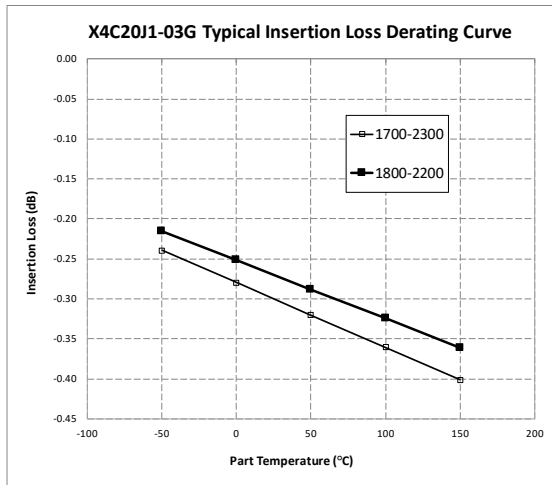

Insertion Loss Derating

The insertion loss, at a given frequency, of a group of couplers is measured at 25°C and then averaged. The measurements are performed under small signal conditions (i.e. using a Vector Network Analyzer). The process is repeated at -55°C, 105°C and 140°C. A best-fit line for the measured data is computed and then plotted from -55°C to 140°C.

Power Derating

The power handling and corresponding power derating plots are a function of the thermal resistance, mounting surface temperature (base plate temperature), maximum continuous operating temperature of the coupler, and the thermal insertion loss. The thermal insertion loss is defined in the Power Handling section of the data sheet.

As the mounting interface temperature approaches the maximum continuous operating temperature, the power handling decreases to zero.

If mounting temperature is greater than 105°C, Xinger coupler will perform reliably as long as the input power is derated to the curve above.

Typical Performance: 1700 MHz to 2300 MHz (Configuration 1)

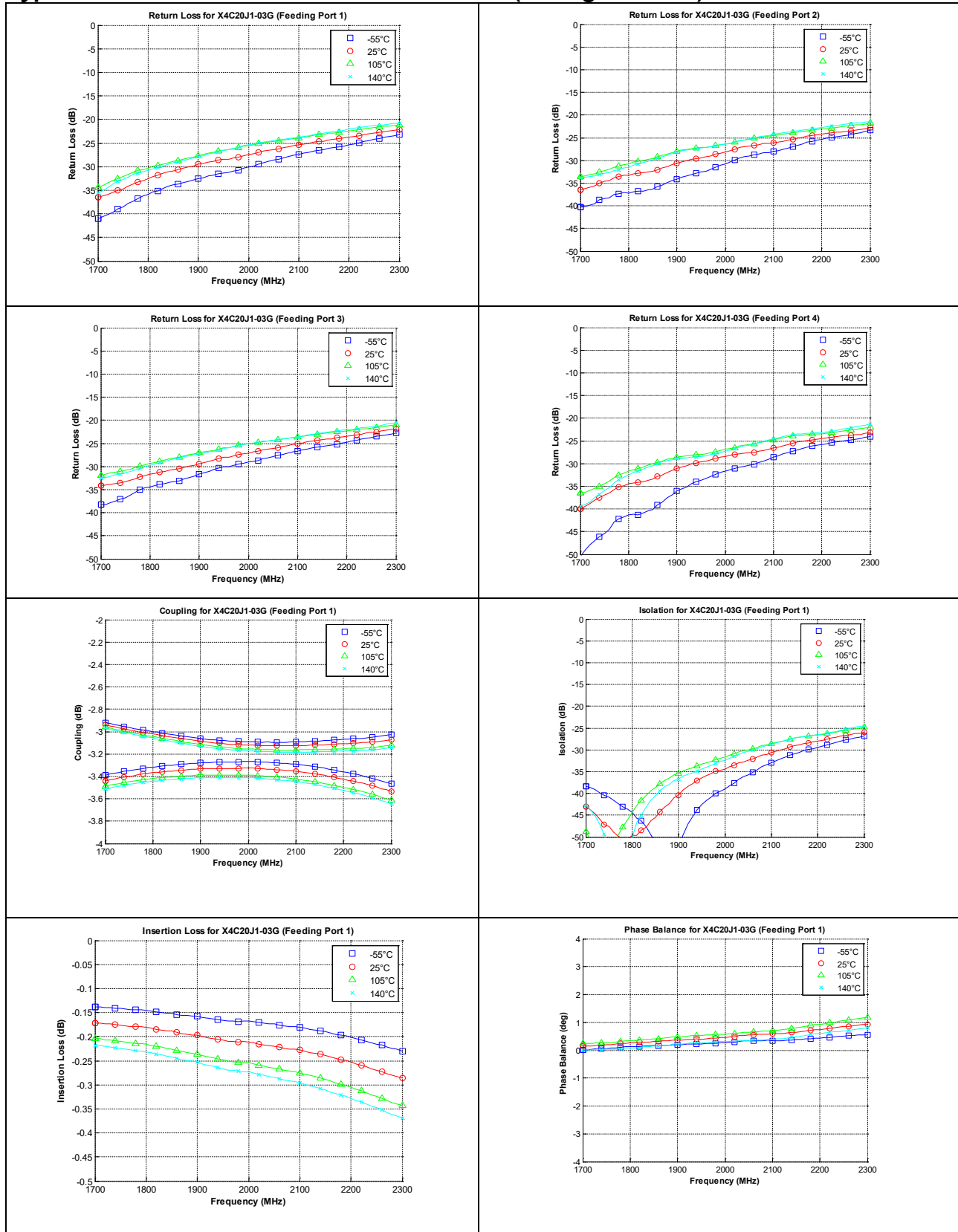

Definition of Measured Specifications

Parameter	Definition	Mathematical Representation
VSWR (Voltage Standing Wave Ratio)	The impedance match of the coupler to a 50Ω system. A VSWR of 1:1 is optimal.	$VSWR = \frac{V_{max}}{V_{min}}$ Vmax = voltage maxima of a standing wave Vmin = voltage minima of a standing wave
Return Loss	The impedance match of the coupler to a 50Ω system. Return Loss is an alternate means to express VSWR.	$Return\ Loss(dB) = 20\log \frac{VSWR + 1}{VSWR - 1}$
Insertion Loss	The input power divided by the sum of the power at the two output ports.	$Insertion\ Loss(dB) = 10\log \frac{P_{in}}{P_{cpl} + P_{direct}}$
Isolation	The input power divided by the power at the isolated port.	$Isolation(dB) = 10\log \frac{P_{in}}{P_{iso}}$
Amplitude Balance	The power at each output divided by the average power of the two outputs.	$10\log \frac{P_{cpl}}{(P_{cpl} + P_{direct})/2}$ $10\log \frac{P_{direct}}{(P_{cpl} + P_{direct})/2}$
Phase Balance	The difference in phase angle between the two output ports.	Phase at coupled port – Phase at direct port
Frequency Sensitivity	The decibel difference between the maximum in band coupling value and the mean coupling, and the decibel difference between the minimum in band coupling value and the mean coupling.	Max Coupling (dB) – Mean Coupling (dB) and Min Coupling (dB) – Mean Coupling (dB)
Group Delay (GD-C)	Group delay is average of group delay's from input port to the coupled port	Average (GD-C)
Group Delay (GD-DC)	Group delay is average of group delay's from input port to the direct port	Average (GD-DC)

*100% RF test is performed per spec definition for pin configuration 1 and 2.

Packaging and Ordering Information

Parts are available in reel and are packaged per EIA 481-D. Parts are oriented in tape and reel as shown below. Minimum order quantities are 4000 per reel.

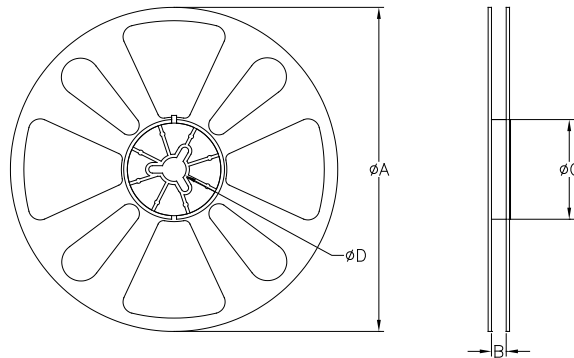
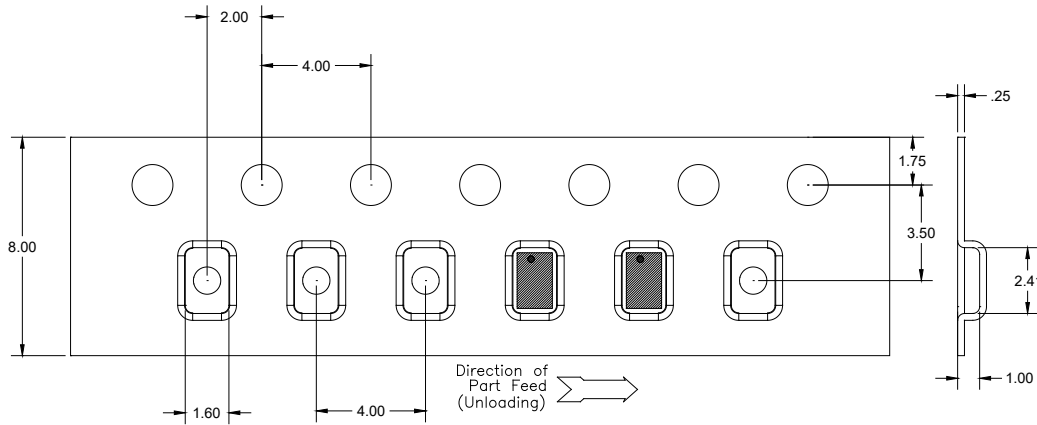

QUANTITY/REEL	REEL DIMENSIONS mm	
4000	ϕA	177.80
	B	8.00
	ϕC	50.80
	ϕD	13.00

Contact us:
rf&s_support@ttm.com