



A Product Line of
Diodes Incorporated



SPECIFICATION FOR APPROVAL

CUSTOMER _____

NOMINAL FREQUENCY _____ 33.000000 MHz _____

HOLDER TYPE _____ TYPE FK 3.2x2.5 SEAM SEALED CRYSTAL CLOCK OSCILLATOR _____

SPEC. NO. (P/N) _____ FK3300011 _____

CUSTOMER P/N _____

ISSUE DATE _____ May 17, 2018 _____

VERSION _____ C _____

APPROVED	PREPARED	QA
<i>Brenda Kuo</i>	<i>Winnie Chang</i>	<i>Dony Yang</i>

Diodes Incorporated

No.2, Ziqiang 5th Rd., Zhongli Industrial Park,
Zhongli Dist., Taoyuan City 32063, Taiwan (R.O.C.)
TEL: 886-3-451-8888
FAX: 886-3-461-3865
<https://www.diodes.com>

*Pb-free
*RoHS Compliant
*HF-Halogen Free
*REACH Compliant

TYPE FK 3.2x2.5 SEAM SEALED CRYSTAL CLOCK OSCILLATOR

FK3300011

VER. C 17-May-18

ELECTRICAL SPECIFICATIONS

SRe Part Number : FK3300011

Item	Symbol	Specifications	Units	Notes
Nominal Frequency	F ₀	33.000000	MHz	
Frequency Stability	FT	± 50	ppm	**See note
Operating Temperature Range	TR	-40 to +85	°C	
Supply Voltage	V _{DD}	+3.3 ± 5.0%	V	
Logic Type	LT	LVC MOS		
Supply Current, Output Enabled	I _{DD} /OE	10	mA	Max.
Supply Current, Output Disabled	I _{DD} /OD	10	µA	Max.
Duty Cycle (Symmetry)	DC/SY	45 / 55	%	Measured 50% of Waveform
Rise / Fall Time	T _R /T _F	5	ns	Max. measured 10/90% of Waveform
Output Voltage "0" Level	V _{OL}	10% V _{DD}	V	Max at I _{OL} = 4.0mA Min.
Output Voltage "1" Level	V _{OH}	90% V _{DD}	V	Min at I _{OH} = -4.0mA Max.
Output Load	CL	15	pF	Max
Jitter, Phase	RMS	1	ps	Max. 12KHz ~ 5MHz Frequency Band
Jitter, Accumulated	RMS(1-σ)	3	ps	Max. 20,000 Consecutive Periods
Jitter, Peak to Peak	Pk-Pk	30	ps	Max. 100,000 Random Periods
Start Up Time		10	ms	Max.
Storage Temperature Range		-55 to +125	°C	

※ This product doesn't include harmful substance that stipulated by SONY SS-00259 Level 1 and S-AT2-001 Level 1 standard. RoHS Compliant (Pb - Free).

**Stability includes all combinations of Operating Temperature, Load changes, rated Input (Supply) Voltage changes, Initial Calibration Tolerance (25°C), Aging (1 year at 25°C Average Effective Ambient Temperature), Shock and Vibration.

Output Enable / Disable Function

Parameter	Min.	Typ.	Max.	Units	Notes
Input Voltage (Pin1), Output Enable	0.7V _{DD}			V	Or Open
Input Voltage (Pin1), Output Disable (low power standby)			0.3V _{DD}	V	Output is Hi-Z
Internal Pullup Resistance	30			KΩ	
Output Disable Delay			50	ns	

TYPE FK 3.2x2.5 SEAM SEALED CRYSTAL CLOCK OSCILLATOR

FK3300011

VER. C 17-May-18

TEST CIRCUIT

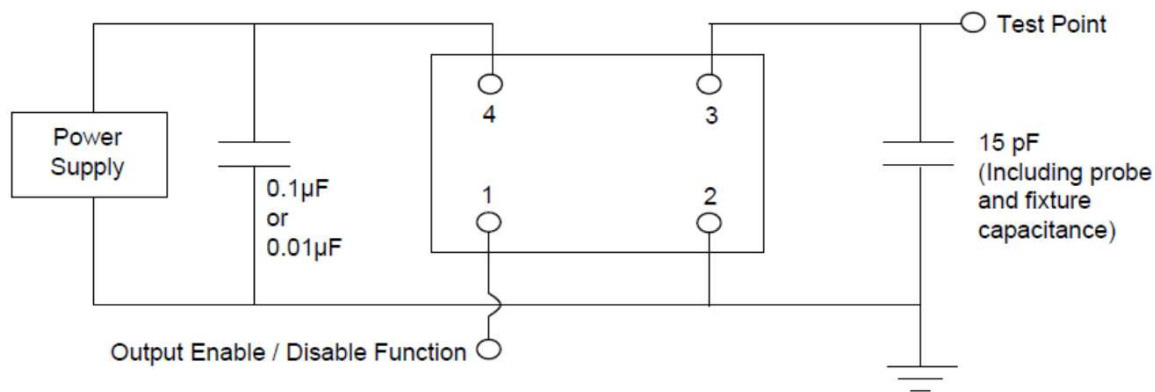

OUTPUT WAVEFORM

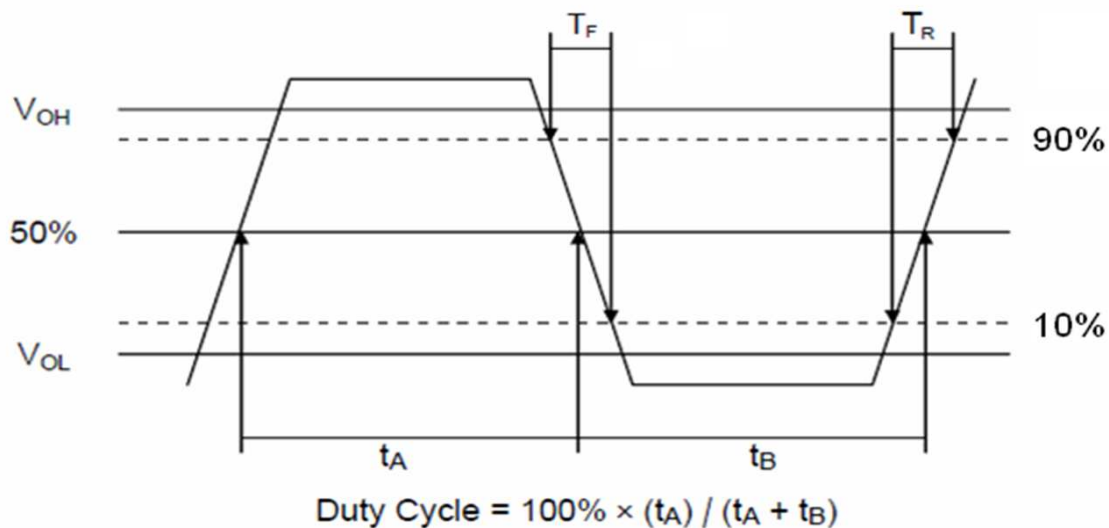

TYPE FK 3.2x2.5 SEAM SEALED CRYSTAL CLOCK OSCILLATOR

FK3300011

VER. C 17-May-18

RELIABILITY SPECIFICATIONS

ENVIRONMENTAL:

- a) THERMAL SHOCK: MIL-STD-883, Method 1011, Condition A
- b) MOISTURE RESISTANCE: MIL-STD-883, Method 1004
- c) VIBRATION: MIL-STD-883, Method 2007, Condition A
- d) RESISTANCE TO SOLDERING HEAT: J-STD-020D Table 5-2 Pb-free devices (except 2 cycles max)
- e) HAZARDOUS SUBSTANCE: Pb - free and RoHS Compliant.

MECHANICAL:

- a) SHOCK: MIL-STD-883, Method 2002, Condition B
- b) SOLDERABILITY: JESD22-B102-D Method 2 (Preconditioning E)
- c) TERMINAL STRENGTH: MIL-STD-883, Method 2004, Test Condition D
- d) GROSS LEAK: MIL-STD-883, Method 1014, Condition C
- e) FINE LEAK: MIL-STD-883, Method 1014, Condition A2, $R1=2 \times 10^{-8}$ atm cc/s
- f) SOLVENT RESISTANCE: MIL-STD-202, Method 215

SUGGESTED IR REFLOW PROFILE

*As per IPC-JEDEC J-STD-020D

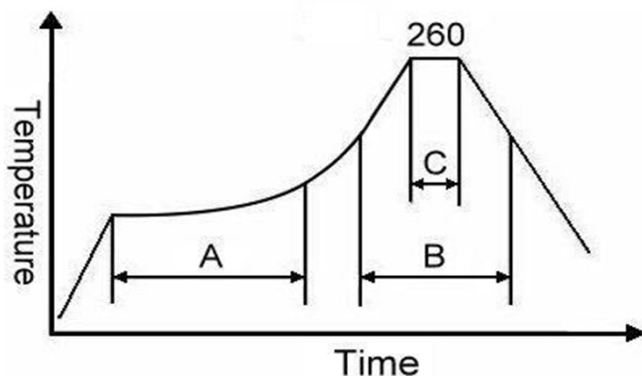

Note:

	Stage	Temperature	Time
A	Preheat	150~200°C	60~120 Sec
B	Primary Heat	217°C	60~150 Sec
C	Peak	260°C	10 Sec

TYPE FK 3.2x2.5 SEAM SEALED CRYSTAL CLOCK OSCILLATOR

FK3300011

VER. C 17-May-18

MARKING

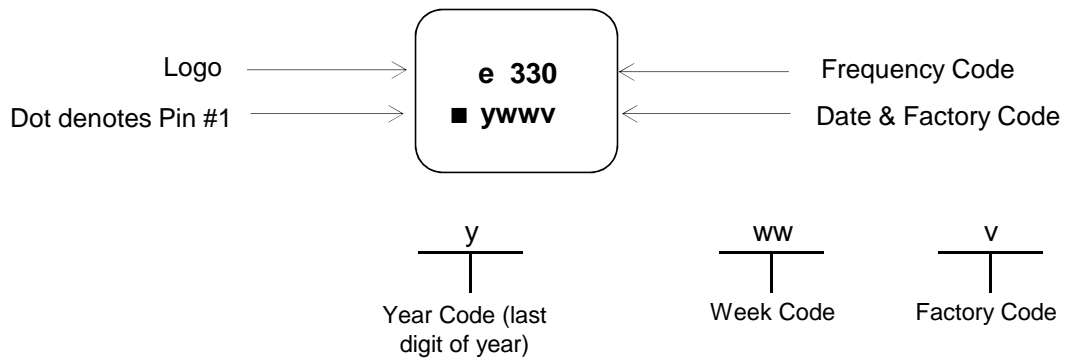

MECHANICAL DRAWINGS (Scale:None. Dimensions are in mm.)

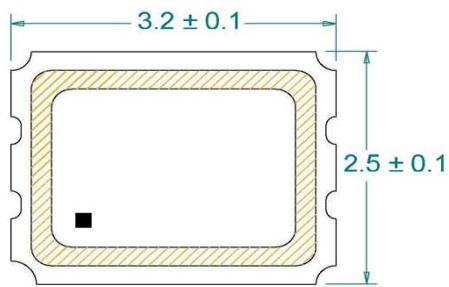

(Bottom View)

Recommended Land Pattern*



*External high-frequency power decoupling is recommended. (see test circuit for minimum recommendation). To ensure optimal performance, do not route traces beneath the package.

Pin	Function
1	OE
2	Ground
3	Clock Output
4	V _{DD}

TYPE FK 3.2x2.5 SEAM SEALED CRYSTAL CLOCK OSCILLATOR

FK3300011

VER. C 17-May-18

TAPE&REEL

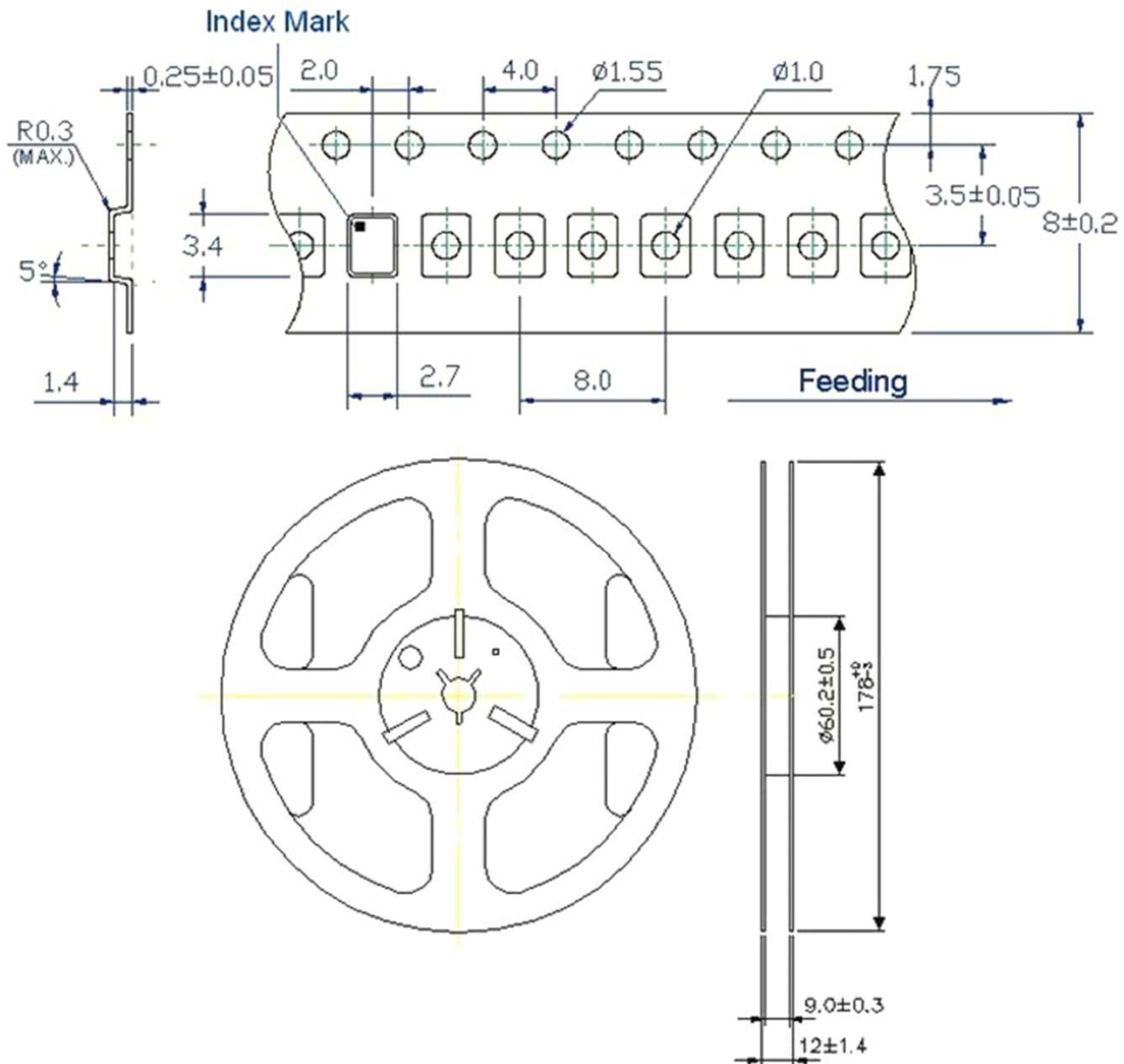

1. 230mm minimum leader which consist of carrier and/or tape followed by a minimum of 160mm of empty carrier tape sealed with cover tape.
2. 160mm minimum trailer of empty carrier tape sealed with cover tape.

TYPE FK 3.2x2.5 SEAM SEALED CRYSTAL CLOCK OSCILLATOR

FK3300011

VER. C 17-May-18

PACKING

