

NuTiny-SDK-M051 User's Manual

For NuMicro M051™ Series

The information described in this document is the exclusive intellectual property of Nuvoton Technology Corporation and shall not be reproduced without permission from Nuvoton.

Nuvoton is providing this document only for reference purposes of NuMicro™ microcontroller based system design. Nuvoton assumes no responsibility for errors or omissions.

All data and specifications are subject to change without notice.

For additional information or questions, please contact: Nuvoton Technology Corporation.

1	Overview	3
2	NuTiny-SDK-M051 introduction	3
2.1	NuTiny -SDK-M051 Jumper Description	4
2.2	Pin Assignment for Extended Connector.....	5
2.3	NuTiny-SDK-M051 PCB Placement	5
3	How to start NuTiny -SDK-M051 on the Keil uVision® IDE.....	6
3.1	Keil uVision® IDE Software Download & Install	6
3.2	Nuvoton Nu-Link Driver Download & Install.....	6
3.3	Hardware Setup.....	6
3.4	Smpl_NuTiny-M051 Example Program	7
4	How to start NuTiny-SDK-M051 on the IAR Embedded Workbench	8
4.1	IAR Embedded Workbench Software Download &Install	8
4.2	Nuvoton Nu-Link Driver Download & Install.....	8
4.3	Hardware Setup.....	8
4.4	Smpl_NuTiny-M051 Example Program	9
5	M052_TINY-EVB Schematic	10
6	To Download NuMicro™ Family Related Files From Nuvoton Company	11
6.1	To Download NuMicro™ Keil uVision® IDE driver	11
6.2	To Download NuMicro™ IAR EWARM driver	12
6.3	To Download NuMicro™ M051 series BSP Software Library	13
7	Revision History	13

1 Overview

NuTiny-SDK-M051 is the specific development tool for NuMicro M051™ series –M052/M054/M058/M0516. Users can use NuTiny-SDK-M051 to develop and verify the application program easily.

NuTiny-SDK-M051 includes 2 portions. One is M052_Tiny-EVB and the other is Nu-Link-Me. M052_Tiny-EVB is evaluation board and Nu-Link-Me is its Debug Adaptor. Thus, users do not need additional ICE equipment.

2 NuTiny-SDK-M051 introduction

NuTiny-SDK-M051 can support NuMicro M051™ series. Figure 2-1 is NuTiny-SDK-M051 for M051 series and the left portion is called M052-TINY-EVB and the right portion is Debug Adaptor called Nu-Link-Me.

M052-TINY-EVB is similar to other development board. Users can use it to develop and verify applications to emulate the real behavior. In fact, the real chip M0516LAN is mounted on the board. The on board chip covers M052, M054 and M058's features. The M052_Tiny-EVB can be a real system controller to design user target system.

Nu-Link-Me is a Debug Adaptor. **The Nu-Link-Me Debug Adaptor connects your PC's USB port to your target system (via Serial Wired Debug Port) and allows you to program and debug embedded programs on the target hardware.** To use Nu-Link-Me Debug adaptor with Keil or IAR Please refer to “Nuvoton NuMicro™ IAR ICE driver user manual “ or Nuvoton NuMicro™ Keil ICE driver user manual” in detail.

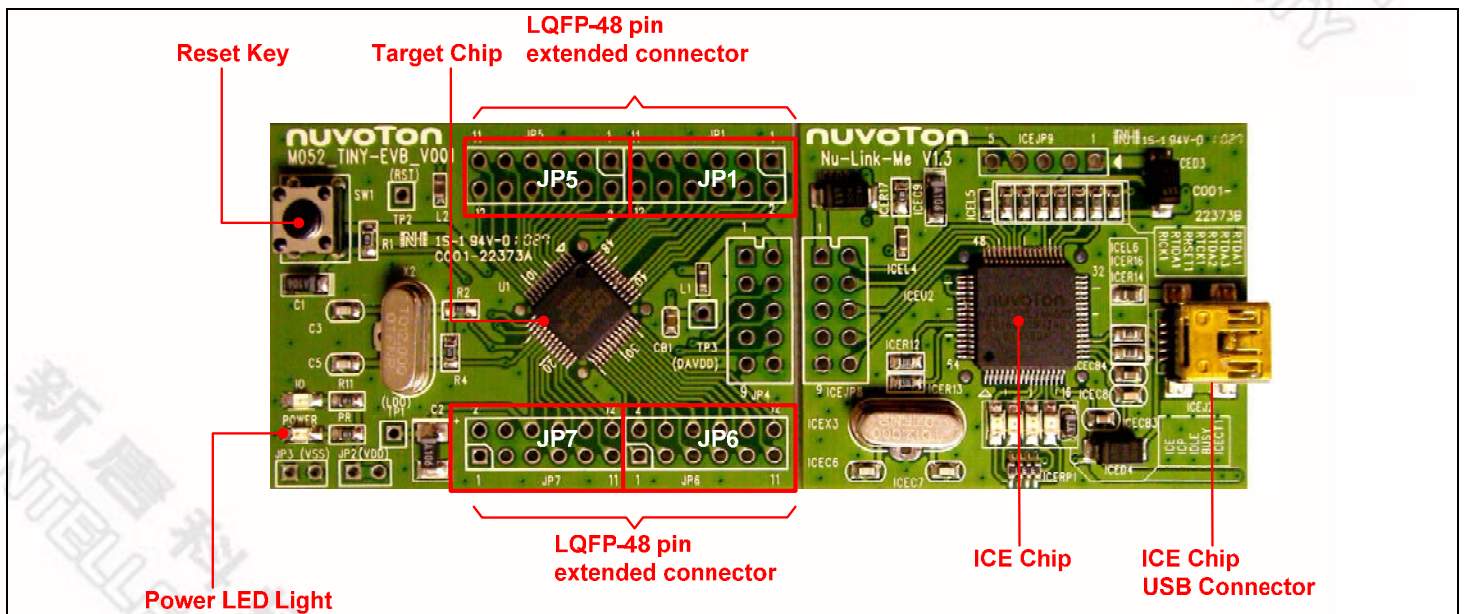

Figure 2-1 NuTiny-SDK-M051 (Green Color PCB Board)

2.1 NuTiny -SDK-M051 Jumper Description

2.1.1 Power Setting

- JP2: VCC5 Voltage connector in M052_TINY-EVB
- J2: USB port in Nu-Link-Me

POWER model	J1 USB port	J2 USB port	JP2 VCC5	MCU Voltage
Model 1	X	Connect to PC	DC 5V output	DC 5V
Model 2	X	X	DC 2.8-5.5V input	Voltage by VCC input

X: Not use.

2.1.2 Debug Connector

- JP4: Target ICE Connector in M052_TINY-EVB
- JP8: Nuvoton ICE Connector in Nu-Link-Me

2.1.3 USB Connector

- J1: mini USB Connector in M052_TINY-EVB
- J2: mini USB Connector in Nu-Link-Me

2.1.4 Extended Connector

- JP1, JP5, JP6 and JP7: Show all of chip pins in M052_TINY-EVB

2.1.5 Reset Button

- SW1: Reset button in M052_TINY-EVB

2.1.6 Power Connector

- JP2: VCC connector in M052_TINY-EVB
- JP3: GND connector in M052_TINY-EVB

2.2 Pin Assignment for Extended Connector

M052_TINY-EVB provides M0516LAN on board and the extended connector for LQFP-48 pin. Table 2-1 is the pin assignment for M0516LAN.

Pin No	Pin Name	Pin No	Pin Name
01	MOSI_0,AIN5,P1.5	25	P2.5,AD13,PWM5
02	MISO_0,AIN6,P1.6	26	P2.6,AD14,PWM6
03	SCLK0,AIN7,P1.7	27	P2.7,AD15,PWM7
04	/RST	28	P4.4,/CS
05	P3.0,RXD	29	P4.5,ALE
06	AVSS	30	P4.6,ICE_CLK
07	P3.1,TXD	31	P4.7,ICE_DATA
08	P3.2,/INT0,STADC	32	P0.7,AD7,SCLK1
09	P3.3,/INT1,MCLK	33	P0.6,AD6,MISO_1
10	P3.4, T0,SDA	34	P0.5,AD5,MOSI_1
11	P3.5,T1,SCL	35	P0.4,AD4,/SS1
12	P4.3,PWM3	36	P4.1,PWM1
13	P3.6,/WR,CKO	37	P0.3,AD3,RTS0
14	P3.7,/RD	38	P0.2,AD2,CST0
15	XTAL2	39	P0.1,AD1,RTS1
16	XTAL1	40	P0.0,AD0,CTS1
17	VSS	41	VDD
18	LDO_CAP	42	AVDD
19	P2.0,AD8,PWM0	43	P1.0,AIN0,P1.0
20	P2.1,AD9,PWM1	44	P1.1,AIN1,T3
21	P2.2,AD10,PWM2	45	P1.2,AIN2,RXD1
22	P2.3,AD11,PWM3	46	P1.3AIN3,TXD1
23	P2.4,AD12,PWM4	47	P1.4,AIN4,/SS0
24	P4.0,PWM0	48	P4.2,PWM2

Table 2-1 pin assignment for M0516LAN

2.3 NuTiny-SDK-M051 PCB Placement

Users can refer Figure 2-2 for the NuTiny -SDK-M051 PCB placement.

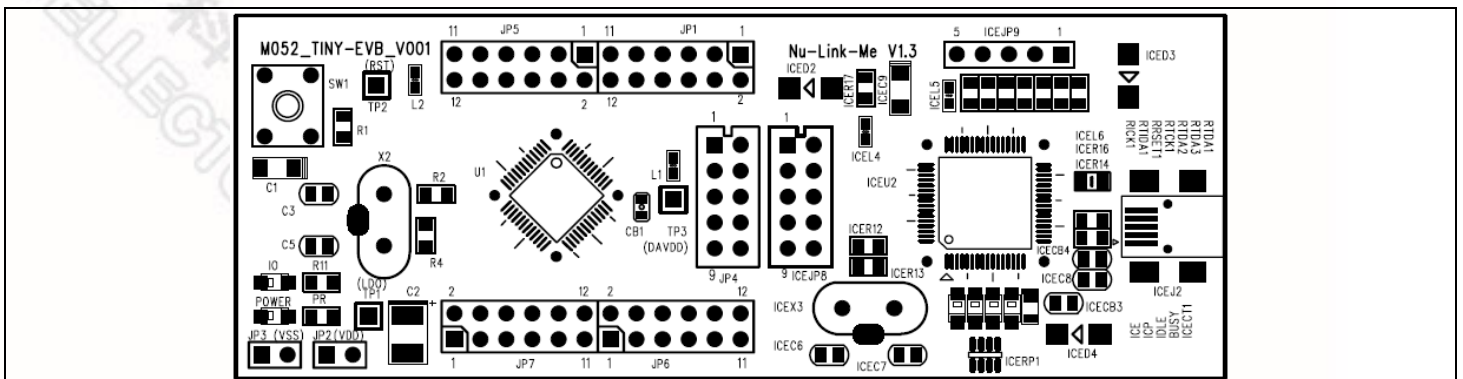

Figure 2-2 NuTiny-SDK-M051 PCB Placement

3 How to start NuTiny -SDK-M051 on the Keil uVision® IDE

3.1 Keil uVision® IDE Software Download & Install

Please connect to Keil company website (<http://www.keil.com>) to download the Keil uVision® IDE and install the RVMDK.

3.2 Nuvoton Nu-Link Driver Download & Install

Please connect to Nuvoton company NuMicro™ website (<http://www.nuvoton.com/NuMicro>) to download “NuMicro™ Keil uVision® IDE driver” file. Please refer the Chapter 6.1 for the detail download flow. When the download had finished, please unzip the file and execute the “Nu-Link_Keil_Driver.exe” to install the driver.

3.3 Hardware Setup

The hardware setup is shown as Figure 3-1

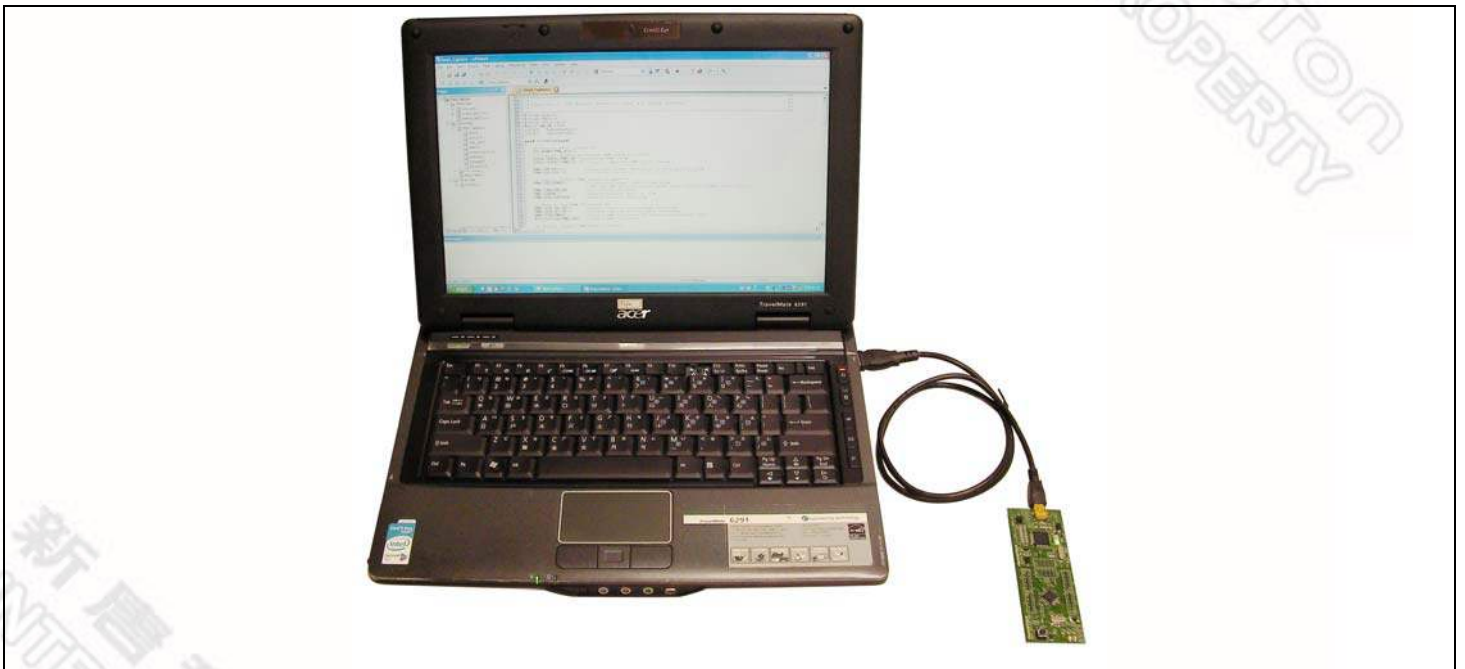

Figure 3-1 NuTiny-SDK-M051 Hardware Setup

3.4 Smpl_NuTiny-M051 Example Program

This example demonstrates the ease of downloading and debugging an application on a NuTiny-SDK-M051 board. The example can be found on the Figure 3-2 list directory.

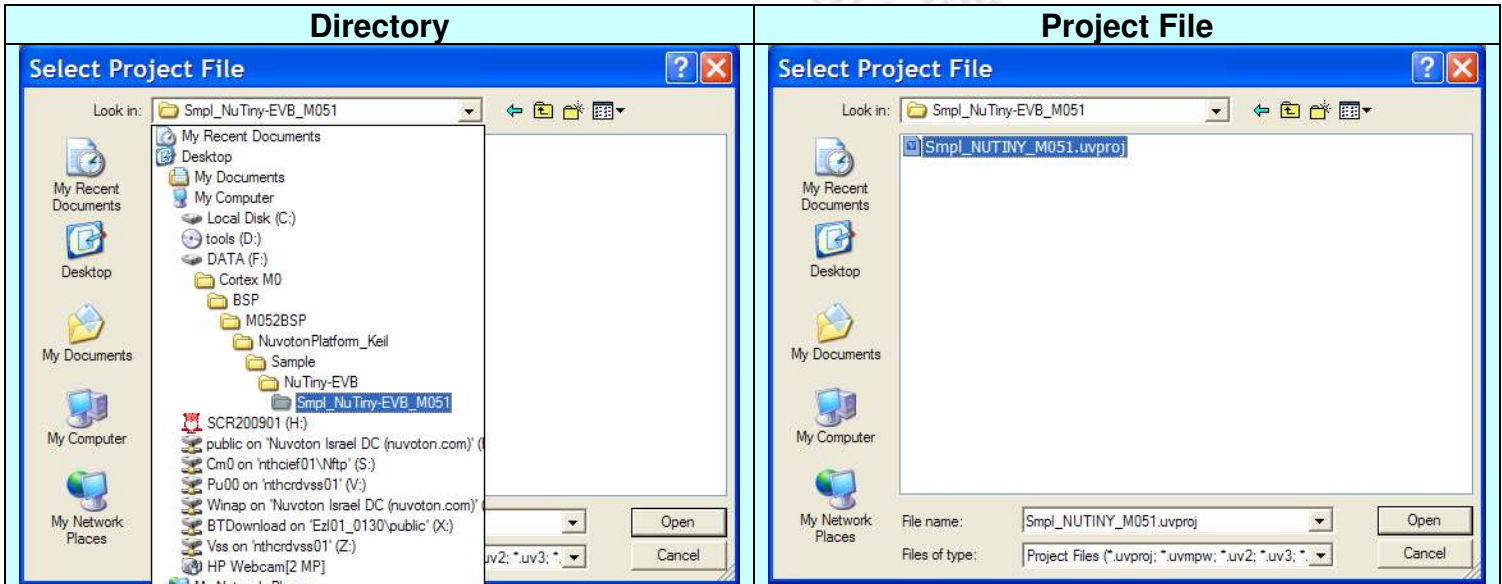

Figure 3-2 Smpl_NuTiny-M051 Example Directory

To use this example:

- **Start uVision**
- Open the Smpl_NuTiny-M051.uvproj project file
Project-Open
- Compile and link the Smpl_NuTiny-M051 application
 Project - Build
- Program the application into on-chip Flash ROM
 Flash – Download

Start debug mode

Using the debugger commands, you may:

- Single step through code
- Run the application\
- Review variables in the watch window
- Reset the device to re-run the application

The LED will toggle on the M052_TINY-EVB board.

4 How to start NuTiny-SDK-M051 on the IAR Embedded Workbench

4.1 IAR Embedded Workbench Software Download & Install

Please connect to IAR company website ([http:// www.iar.com](http://www.iar.com)) to download the IAR Embedded Workbench and install the EWARM.

4.2 Nuvoton Nu-Link Driver Download & Install

Please connect to Nuvoton company NuMicro™ website (www.nuvoton.com/NuMicro) to download “NuMicro™ IAR ICE driver user manual” file. Please refer the 6.2 for the detail download flow. When the download had finished, please unzip the file and execute the “Nu-Link_IAR_Driver.exe” to install the driver.

4.3 Hardware Setup

The hardware setup is shown as Figure 3-1

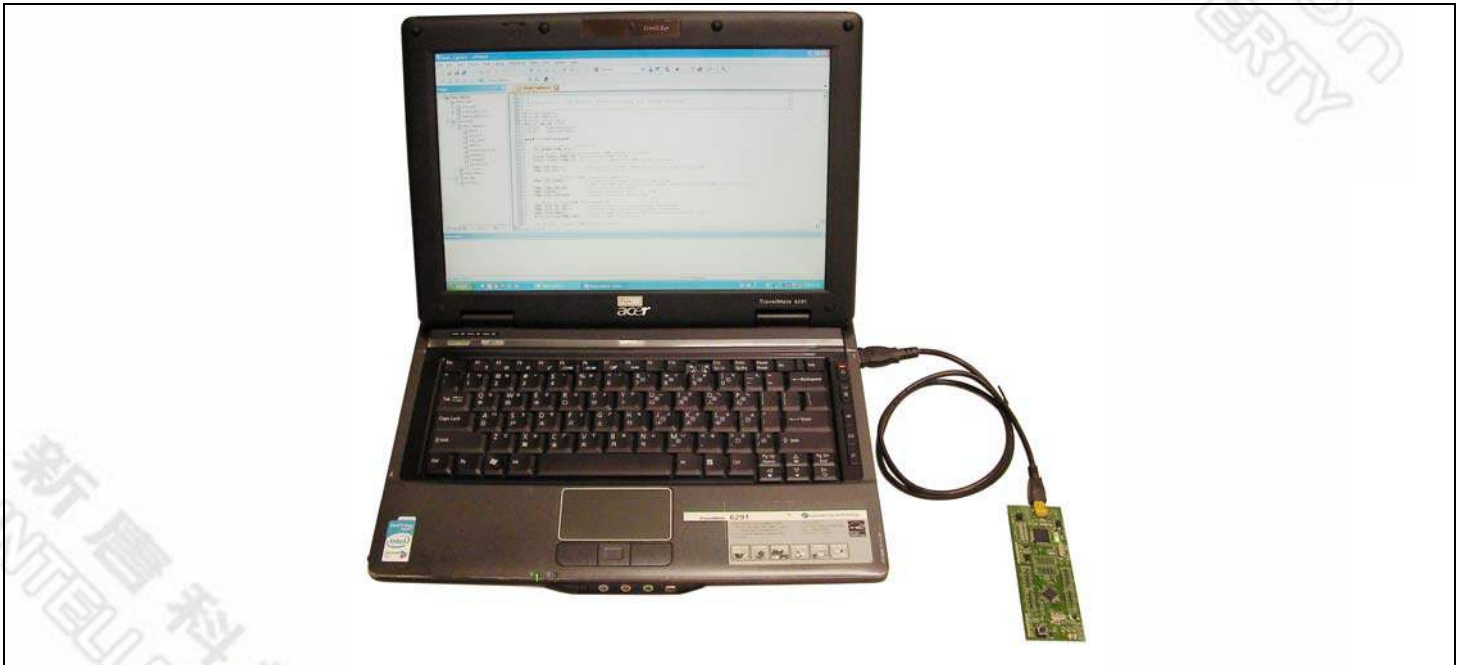

Figure 4-1 NuTiny- SDK-M051 Hardware Setup



4.4 Smpl_NuTiny-M051 Example Program

This example demonstrates the ease of downloading and debugging an application on a NuTiny-SDK-M051 board. The example can be found on the Figure 3-2 list directory. (Samples code can be download from Nuvoton website)

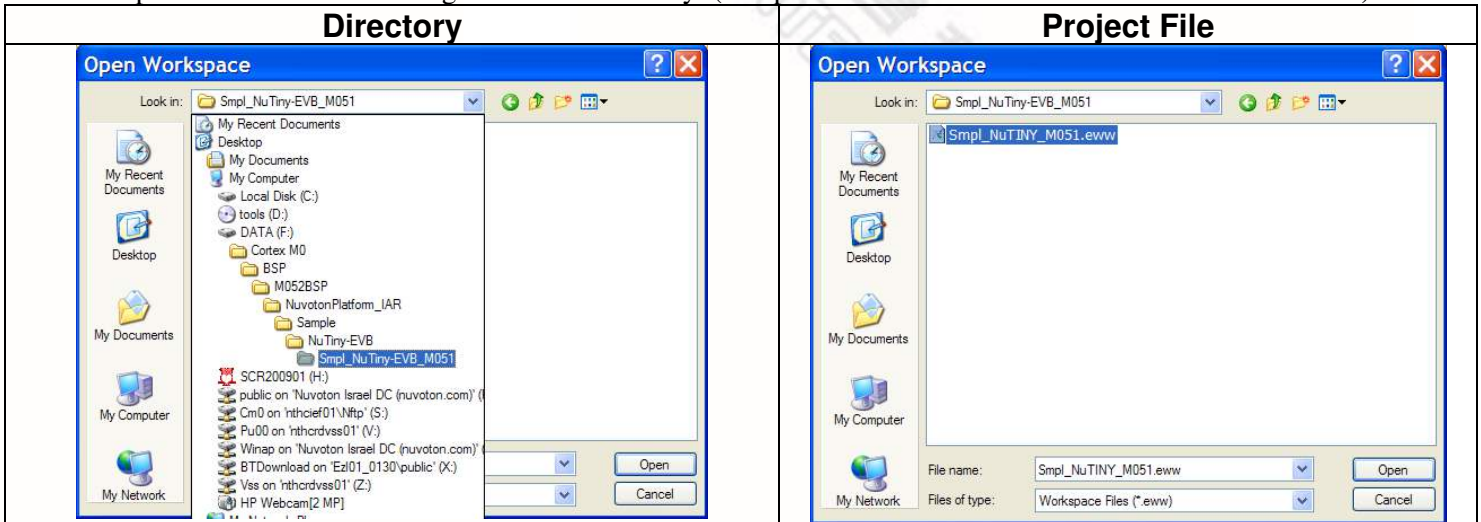



Figure 4-2 Smpl_NuTiny-M051 Example Directory

To use this example:

-  Start IAR Embedded Workbench
- Open the Smpl_NuTiny-M051.eww workspace file
File-Open-Workspace
- Compile and link the Smpl_NuTiny-M051 application



Project - Make

- Program the application into on-chip Flash ROM



Project – Download and Debug

The I/O will toggle on the M052_TINY-EVB board.

5 M052_TINY-EVB Schematic

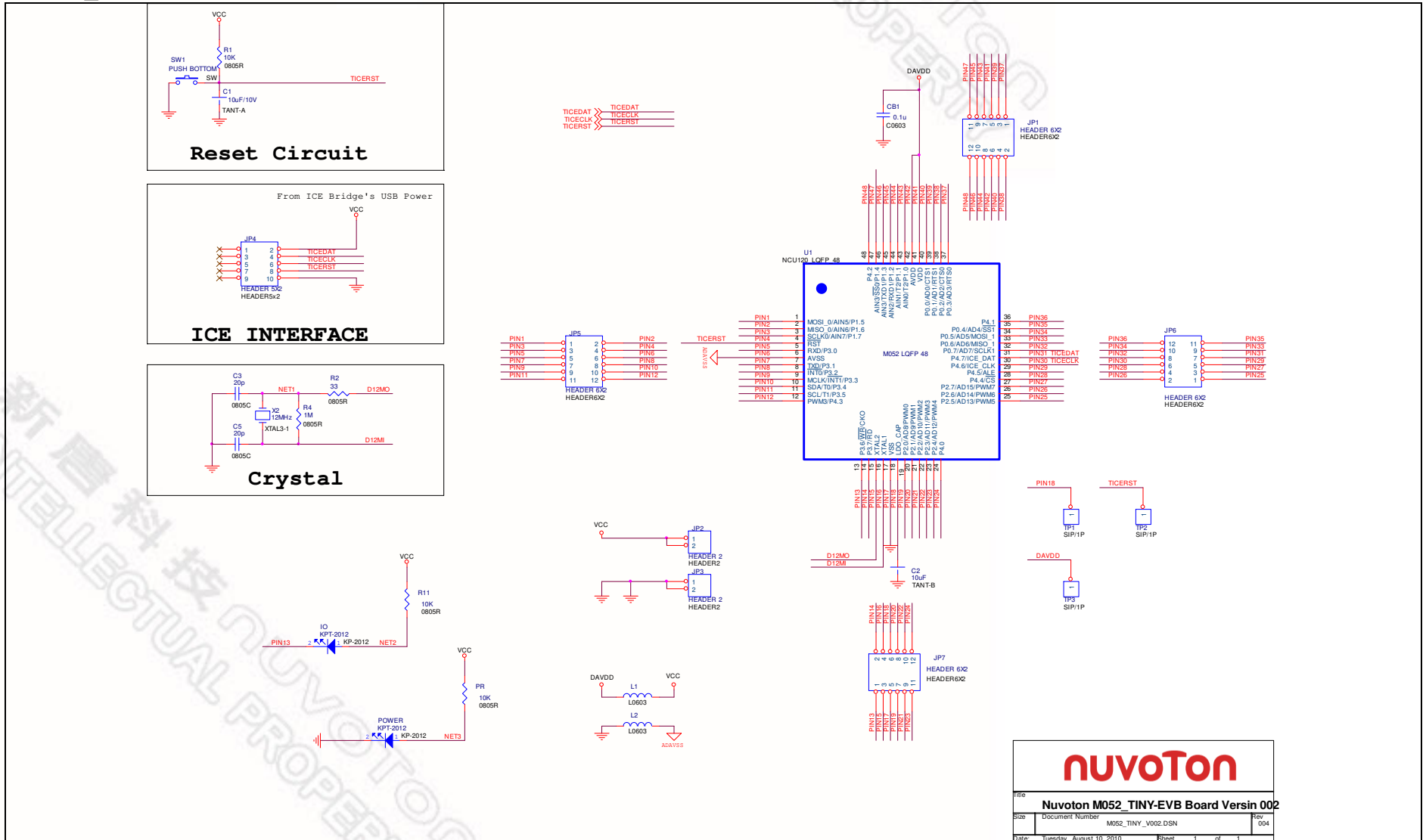

nuvoTon		
File: Nuvoton M052_TINY-EVB Board Versin 002		
Size:	Document Number: M052_TINY_V002.DSN	Rev: 004
Date: Tuesday, August 10, 2010	Sheet: 1	of 1

6 To Download NuMicro™ Family Related Files From Nuvoton Company

6.1 To Download NuMicro™ Keil uVision® IDE driver

<p>Step1</p>	<p>To connect to the Nuvoton NuMicro™ Website: http://www.nuvoton.com/NuMicro</p>																																							
<p>Step2</p>	<p>ARM Cortex™-M0 NuMicro™ Family</p> <p>NuMicro™ Family is nuvoton's brand-new 32-bit microcontroller product line based on the ARM® Cortex™-M0 with peripherals to offer superb features and connectivity. NuMicro™ Family is based on the ARM® Cortex™-M0 low power, high performance microcontroller with speed up to 45DMIPS and SRAM up to 16K bytes. Built-in Flash EPROM up to 128K bytes, ISP, IAP and ICP functions make program updates quick and easy. The connectivity-capable peripherals provide high speed UART, SPI, I2C, I2S, CAN Bus and USB 2.0 Full Speed Device functions. The family includes members with built-in mixed-signal unit offering the user 8 channels of 12-bit Analog To Digital Conversion and two analog comparators. Besides the highly integrated features, NuMicro™ Family is designed for wide operating voltage, high noise immunity and industrial/automotive temperature grades to satisfy automotive, industrial control, data communication and consumer product applications. Moreover, NuMicro™ Family offers industry leading ARM® Cortex™-M0 microcontroller that brings 32-bit performance at a cost equivalent to traditional 8-bit microcontrollers.</p> <p>Click here to enter Development Tools page</p> <p>NuMicro™ Family</p> <p>* High Density with more functionality *</p> <ul style="list-style-type: none"> Up to 512KB Flash ROM Up to 64KB SRAM 1x12-bit ADC Ethernet MAC Motor PWM Cortex-M0 UART 																																							
<p>Step 3</p>	<table border="1"> <tr> <td>Nu-LB</td> <td> <ul style="list-style-type: none"> Nu-LB </td> <td> NUC100 NUC120 NUC130 NUC140 </td> <td> <ul style="list-style-type: none"> A Starter Kit made by Nuvoton Keil MDK-ARM (evaluation version) included Examples with source code included </td> <td></td> <td>Check Disty!</td> </tr> <tr> <td>Nu-IAR-SKT</td> <td> <ul style="list-style-type: none"> EVB w/M-Link USB Cable Setup CD </td> <td> NUC100 NUC120 NUC130 NUC140 </td> <td> <ul style="list-style-type: none"> Starter Kit made by IAR IAR EWARM (evaluation version) Included IAR C/C++ Compiler included USB Plug & Play </td> <td></td> <td>Buy Online!</td> </tr> <tr> <td>Nu-Keil-SKT</td> <td> <ul style="list-style-type: none"> U-LINK-ME MCBNUC1XX USB Cable Setup CD </td> <td> NUC100 NUC120 NUC130 NUC140 </td> <td> <ul style="list-style-type: none"> Starter Kit made by Keil Keil MDK –ARM (evaluation version) included ARM C/C++ Compiler included USB Plug & Play </td> <td></td> <td>Check Disty!</td> </tr> </table> <p>File Download</p> <table border="1"> <thead> <tr> <th>File name</th> <th>Description</th> <th>Version</th> </tr> </thead> <tbody> <tr> <td> NUC1xx Quick Start Guide for Keil uVision4 V1.00.zip</td> <td>Quick start guide using Keil™ RVMDK</td> <td>V1.00</td> </tr> <tr> <td> NuMicro Keil uVision® IDE driver (Build 4033) V1.02.zip</td> <td>The Nuvoton NuMicro Keil uVision® Driver allows the Keil uVision® IDE to communicate with Nuvoton Nu-Link ICE bridge.</td> <td>V1.02</td> </tr> <tr> <td> NuMicro IAR Embedded Workbench® driver (Build 4033) V1.02.zip</td> <td>The Nuvoton NuMicro IAR Embedded Workbench® driver allows the IAR Embedded Workbench IDE above v5.41 to communicate with Nuvoton Nu-Link ICE bridge.</td> <td>V1.02</td> </tr> <tr> <td> NuMicro ICP (Build 4033) V1.02.zip</td> <td>NuMicro ICP tool & user manual</td> <td>V1.02</td> </tr> <tr> <td> NUC1xx ISP V1.08.zip</td> <td>NUC1xx ISP tool & user manual</td> <td>V1.08</td> </tr> <tr> <td> NUC1xx Nu-EVB_001 Board Schematic v2.0.pdf</td> <td>NUC1xx Nu-EVB_001 Board Schematic</td> <td>V2.0</td> </tr> </tbody> </table> <p>To download the file</p>	Nu-LB	<ul style="list-style-type: none"> Nu-LB 	NUC100 NUC120 NUC130 NUC140	<ul style="list-style-type: none"> A Starter Kit made by Nuvoton Keil MDK-ARM (evaluation version) included Examples with source code included 		Check Disty!	Nu-IAR-SKT	<ul style="list-style-type: none"> EVB w/M-Link USB Cable Setup CD 	NUC100 NUC120 NUC130 NUC140	<ul style="list-style-type: none"> Starter Kit made by IAR IAR EWARM (evaluation version) Included IAR C/C++ Compiler included USB Plug & Play 		Buy Online!	Nu-Keil-SKT	<ul style="list-style-type: none"> U-LINK-ME MCBNUC1XX USB Cable Setup CD 	NUC100 NUC120 NUC130 NUC140	<ul style="list-style-type: none"> Starter Kit made by Keil Keil MDK –ARM (evaluation version) included ARM C/C++ Compiler included USB Plug & Play 		Check Disty!	File name	Description	Version	NUC1xx Quick Start Guide for Keil uVision4 V1.00.zip	Quick start guide using Keil™ RVMDK	V1.00	NuMicro Keil uVision® IDE driver (Build 4033) V1.02.zip	The Nuvoton NuMicro Keil uVision® Driver allows the Keil uVision® IDE to communicate with Nuvoton Nu-Link ICE bridge.	V1.02	NuMicro IAR Embedded Workbench® driver (Build 4033) V1.02.zip	The Nuvoton NuMicro IAR Embedded Workbench® driver allows the IAR Embedded Workbench IDE above v5.41 to communicate with Nuvoton Nu-Link ICE bridge.	V1.02	NuMicro ICP (Build 4033) V1.02.zip	NuMicro ICP tool & user manual	V1.02	NUC1xx ISP V1.08.zip	NUC1xx ISP tool & user manual	V1.08	NUC1xx Nu-EVB_001 Board Schematic v2.0.pdf	NUC1xx Nu-EVB_001 Board Schematic	V2.0
Nu-LB	<ul style="list-style-type: none"> Nu-LB 	NUC100 NUC120 NUC130 NUC140	<ul style="list-style-type: none"> A Starter Kit made by Nuvoton Keil MDK-ARM (evaluation version) included Examples with source code included 		Check Disty!																																			
Nu-IAR-SKT	<ul style="list-style-type: none"> EVB w/M-Link USB Cable Setup CD 	NUC100 NUC120 NUC130 NUC140	<ul style="list-style-type: none"> Starter Kit made by IAR IAR EWARM (evaluation version) Included IAR C/C++ Compiler included USB Plug & Play 		Buy Online!																																			
Nu-Keil-SKT	<ul style="list-style-type: none"> U-LINK-ME MCBNUC1XX USB Cable Setup CD 	NUC100 NUC120 NUC130 NUC140	<ul style="list-style-type: none"> Starter Kit made by Keil Keil MDK –ARM (evaluation version) included ARM C/C++ Compiler included USB Plug & Play 		Check Disty!																																			
File name	Description	Version																																						
NUC1xx Quick Start Guide for Keil uVision4 V1.00.zip	Quick start guide using Keil™ RVMDK	V1.00																																						
NuMicro Keil uVision® IDE driver (Build 4033) V1.02.zip	The Nuvoton NuMicro Keil uVision® Driver allows the Keil uVision® IDE to communicate with Nuvoton Nu-Link ICE bridge.	V1.02																																						
NuMicro IAR Embedded Workbench® driver (Build 4033) V1.02.zip	The Nuvoton NuMicro IAR Embedded Workbench® driver allows the IAR Embedded Workbench IDE above v5.41 to communicate with Nuvoton Nu-Link ICE bridge.	V1.02																																						
NuMicro ICP (Build 4033) V1.02.zip	NuMicro ICP tool & user manual	V1.02																																						
NUC1xx ISP V1.08.zip	NUC1xx ISP tool & user manual	V1.08																																						
NUC1xx Nu-EVB_001 Board Schematic v2.0.pdf	NUC1xx Nu-EVB_001 Board Schematic	V2.0																																						
<p>Step 4</p>	<p>To download the :uMicro Keil uVision® IDE driver</p>																																							

6.2 To Download NuMicro™ IAR EWARM driver

<p>Step1</p>	<p>To connect to the Nuvoton NuMicro™ Website: http://www.nuvoton.com/NuMicro</p>																																							
<p>Step2</p>	<p>ARM Cortex™-M0 NuMicro™ Family</p> <p>NuMicro™ Family is nuvoton's brand-new 32-bit microcontroller product line based on the ARM® Cortex™-M0 with peripherals to offer superb features and connectivity. NuMicro™ Family is based on the ARM® Cortex™-M0 low power, high performance microcontroller with speed up to 45DMIPS and SRAM up to 16K bytes. Built-in Flash EPROM up to 128K bytes, ISP, IAP and ICP functions make program updates quick and easy. The connectivity-capable peripherals provide high speed UART, SPI, I2C, I2S, CAN Bus and USB 2.0 Full Speed Device functions. The family includes members with built-in mixed-signal unit offering the user 8 channels of 12-bit Analog-To-Digital Conversion and two analog comparators. Besides the highly integrated features, NuMicro™ Family is designed for wide operating voltage, high noise immunity and industrial/automotive temperature grades to catch automotive, industrial control, data communication and consumer product applications. Moreover, NuMicro™ Family offers industry leading ARM® Cortex™-M0 microcontroller that brings 32-bit performance at a cost equivalent to traditional 9-bit microcontrollers.</p> <p>NuMicro™ Family</p> <p>High Density with more functionality</p> <ul style="list-style-type: none"> Up to 512KB Flash ROM Up to 64KB SRAM 1x12-bit ADC Ethernet MAC Motor PWM Cortex-M0 UART 																																							
<p>Step3</p>	<table border="1"> <tr> <td>Nu-LB</td> <td> <ul style="list-style-type: none"> Nu-LB </td> <td> NUC100 NUC120 NUC130 NUC140 </td> <td> <ul style="list-style-type: none"> A Starter Kit made by Nuvoton Keil MDK-ARM (evaluation version) included Examples with source code included </td> <td></td> <td>Check Disty!</td> </tr> <tr> <td>Nu-IAR-SKT</td> <td> <ul style="list-style-type: none"> EVB w/M-Link USB Cable Setup CD </td> <td> NUC100 NUC120 NUC130 NUC140 </td> <td> <ul style="list-style-type: none"> Starter Kit made by IAR IAR EWARM (evaluation version) Included IAR C/C++ Compiler included USB Plug & Play </td> <td></td> <td>Buy Online!</td> </tr> <tr> <td>Nu-Keil-SKT</td> <td> <ul style="list-style-type: none"> U-LINK-ME MCBNUC1XX USB Cable Setup CD </td> <td> NUC100 NUC120 NUC130 NUC140 </td> <td> <ul style="list-style-type: none"> Starter Kit made by Keil Keil MDK –ARM (evaluation version) included ARM C/C++ Compiler included USB Plug & Play </td> <td></td> <td>Check Disty!</td> </tr> </table> <p>File Download</p> <table border="1"> <thead> <tr> <th>File name</th> <th>Description</th> <th>Version</th> </tr> </thead> <tbody> <tr> <td> NUC1xx Quick Start Guide for Keil uVision4 V1.00.zip</td> <td>Quick start guide using Keil™ RVMDK</td> <td>V1.00</td> </tr> <tr> <td> NuMicro Keil uVision® IDE driver (Build 4033) V1.02.zip</td> <td>The Nuvoton NuMicro Keil uVision® Driver allows the Keil uVision® IDE to communicate with Nuvoton Nu-Link ICE bridge.</td> <td>V1.02</td> </tr> <tr> <td> NuMicro IAR Embedded Workbench® driver (Build 4033) V1.02.zip</td> <td>The Nuvoton NuMicro IAR Embedded Workbench® driver allows the IAR Embedded Workbench IDE above v5.41 to communicate with Nuvoton Nu-Link ICE bridge.</td> <td>V1.02</td> </tr> <tr> <td> NuMicro ICP (Build 4033) V1.02.zip</td> <td>NuMicro ICP tool & user manual</td> <td>V1.02</td> </tr> <tr> <td> NUC1xx ISP V1.08.zip</td> <td>NUC1xx ISP tool & user manual</td> <td>V1.08</td> </tr> <tr> <td> NUC1xx Nu-EVB_001 Board Schematic v2.0.pdf</td> <td>NUC1xx Nu-EVB_001 Board Schematic</td> <td>V2.0</td> </tr> </tbody> </table> <p>A yellow callout bubble points to the 'NuMicro IAR Embedded Workbench® driver (Build 4033) V1.02.zip' file in the table.</p>	Nu-LB	<ul style="list-style-type: none"> Nu-LB 	NUC100 NUC120 NUC130 NUC140	<ul style="list-style-type: none"> A Starter Kit made by Nuvoton Keil MDK-ARM (evaluation version) included Examples with source code included 		Check Disty!	Nu-IAR-SKT	<ul style="list-style-type: none"> EVB w/M-Link USB Cable Setup CD 	NUC100 NUC120 NUC130 NUC140	<ul style="list-style-type: none"> Starter Kit made by IAR IAR EWARM (evaluation version) Included IAR C/C++ Compiler included USB Plug & Play 		Buy Online!	Nu-Keil-SKT	<ul style="list-style-type: none"> U-LINK-ME MCBNUC1XX USB Cable Setup CD 	NUC100 NUC120 NUC130 NUC140	<ul style="list-style-type: none"> Starter Kit made by Keil Keil MDK –ARM (evaluation version) included ARM C/C++ Compiler included USB Plug & Play 		Check Disty!	File name	Description	Version	NUC1xx Quick Start Guide for Keil uVision4 V1.00.zip	Quick start guide using Keil™ RVMDK	V1.00	NuMicro Keil uVision® IDE driver (Build 4033) V1.02.zip	The Nuvoton NuMicro Keil uVision® Driver allows the Keil uVision® IDE to communicate with Nuvoton Nu-Link ICE bridge.	V1.02	NuMicro IAR Embedded Workbench® driver (Build 4033) V1.02.zip	The Nuvoton NuMicro IAR Embedded Workbench® driver allows the IAR Embedded Workbench IDE above v5.41 to communicate with Nuvoton Nu-Link ICE bridge.	V1.02	NuMicro ICP (Build 4033) V1.02.zip	NuMicro ICP tool & user manual	V1.02	NUC1xx ISP V1.08.zip	NUC1xx ISP tool & user manual	V1.08	NUC1xx Nu-EVB_001 Board Schematic v2.0.pdf	NUC1xx Nu-EVB_001 Board Schematic	V2.0
Nu-LB	<ul style="list-style-type: none"> Nu-LB 	NUC100 NUC120 NUC130 NUC140	<ul style="list-style-type: none"> A Starter Kit made by Nuvoton Keil MDK-ARM (evaluation version) included Examples with source code included 		Check Disty!																																			
Nu-IAR-SKT	<ul style="list-style-type: none"> EVB w/M-Link USB Cable Setup CD 	NUC100 NUC120 NUC130 NUC140	<ul style="list-style-type: none"> Starter Kit made by IAR IAR EWARM (evaluation version) Included IAR C/C++ Compiler included USB Plug & Play 		Buy Online!																																			
Nu-Keil-SKT	<ul style="list-style-type: none"> U-LINK-ME MCBNUC1XX USB Cable Setup CD 	NUC100 NUC120 NUC130 NUC140	<ul style="list-style-type: none"> Starter Kit made by Keil Keil MDK –ARM (evaluation version) included ARM C/C++ Compiler included USB Plug & Play 		Check Disty!																																			
File name	Description	Version																																						
NUC1xx Quick Start Guide for Keil uVision4 V1.00.zip	Quick start guide using Keil™ RVMDK	V1.00																																						
NuMicro Keil uVision® IDE driver (Build 4033) V1.02.zip	The Nuvoton NuMicro Keil uVision® Driver allows the Keil uVision® IDE to communicate with Nuvoton Nu-Link ICE bridge.	V1.02																																						
NuMicro IAR Embedded Workbench® driver (Build 4033) V1.02.zip	The Nuvoton NuMicro IAR Embedded Workbench® driver allows the IAR Embedded Workbench IDE above v5.41 to communicate with Nuvoton Nu-Link ICE bridge.	V1.02																																						
NuMicro ICP (Build 4033) V1.02.zip	NuMicro ICP tool & user manual	V1.02																																						
NUC1xx ISP V1.08.zip	NUC1xx ISP tool & user manual	V1.08																																						
NUC1xx Nu-EVB_001 Board Schematic v2.0.pdf	NUC1xx Nu-EVB_001 Board Schematic	V2.0																																						
<p>Step4</p>	<p>To download the NuMicro™ IAR Embedded Workbench® driver</p>																																							

6.3 To Download NuMicro™ M051 series BSP Software Library

Step1	To connect to the Nuvoton NuMicro™ Website: http://www.nuvoton.com/NuMicro
Step2	
Step 3	To download the NuMicro M051™ series software library

7 Revision History

Version	Date	Page	Description
1.0	Aug. 20, 2010	--	Initial Issued



Important Notice

Nuvoton products are not designed, intended, authorized or warranted for use as components in systems or equipment intended for surgical implantation, atomic energy control instruments, airplane or spaceship instruments, transportation instruments, traffic signal instruments, combustion control instruments, or for other applications intended to support or sustain life. Further more, Nuvoton products are not intended for applications wherein failure of Nuvoton products could result or lead to a situation wherein personal injury, death or severe property or environmental damage could occur.

Nuvoton customers using or selling these products for use in such applications do so at their own risk and agree to fully indemnify Nuvoton for any damages resulting from such improper use or sales.

Please note that all data and specifications are subject to change without notice. All the trademarks of products and companies mentioned in this datasheet belong to their respective owners.