



SPECIFICATION FOR APPROVAL

Customer : STD

Description : DC FAN

Customer Part No. _____ REV. : _____

Delta Model No. : GFB0412ES-E REV. : 00

Sample Issue No. : _____

Sample Issue Date : JAN.21 2020

PLEASE SEND ONE COPY OF THIS SPECIFICATION BACK AFTER YOU SIGNED APPROVAL FOR PRODUCTION PRE-ARRANGMENT.

APPROVED BY:

DATE :

DELTA ELECTRONICS, INC.
TAOYUAN PLANT
252, SHANGYING ROAD, GUISHAN INDUSTRIAL ZONE,
TAOYUAN CITY 33341, TAIWAN
TEL:886-(0)3-3591968
FAX:886-(0)3-3591991

DELTA ELECTRONICS, INC.
252, SHANGYING ROAD, GUISHAN INDUSTRIAL ZONE,
TAOYUAN CITY 33341, TAIWAN

TEL : 886-(0)3-3591968
FAX : 886-(0)3-3591991

STATEMENT OF DEVIATION

NONE

DESCRIPTION:

DELTA ELECTRONICS, INC.

252, SHANGYING ROAD, GUISHAN INDUSTRIAL ZONE TEL : 886-(0)3-3591968

TAOYUAN CITY 33341, TAIWAN

FAX : 886-(0)3-3591991

Specification For Approval

Customer : STD

Description : DC FAN

Customer P/N :

rev. :

Delta model no. :

GFB0412ES-E

Delta Safety Model No.:

GFB0412ES-E

Sample revision. :

00

Issue no.:

Sample issue date :

JAN.21 2020

Quantity :

1. SCOPE:

THIS SPECIFICATION DEFINES THE ELECTRICAL AND MECHANICAL CHARACTERISTICS OF THE DC BRUSHLESS AXIAL FLOW FAN. THE FAN MOTORS ARE WITH THREE PHASES AND FOUR POLES.

2. CHARACTERS:

*THE PERFORMANCE IS DEFINED BY ONE RAW FAN ALONE.

ITEM	DESCRIPTION
RATED VOLTAGE	12V
OPERATION VOLTAGE	10.8 - 13.2 VDC
INPUT CURRENT (AVG.) (TEST UNDER FREE AIR)	3.25 (MAX. 3.90) A SAFETY CURRENT ON LABEL : 4.50 A
INPUT POWER(AVG.) (TEST UNDER FREE AIR)	39.0 (MAX. 46.8) W
MAX. CURRENT UNDER PRESSURE(AVG)	MAX 4.40 A
SPEED	FRONT 29500 ±10% R.P.M. REAR 26500 ±10% R.P.M.
START UP TIME (BRAKE TIME+SOFTSTART TIME)	< 15 SECOND (FROM STOP WITH BRAKE TIME TO FULL SPEED)
MAX. AIR FLOW (AT ZERO STATIC PRESSURE)	0.960 (MIN. 0.864) M ³ /MIN. 33.90 (MIN. 30.51) CFM
MAX. AIR PRESSURE (AT ZERO AIRFLOW)	163.58 (MIN. 132.49) mmH ₂ O 6.44 (MIN. 5.216) inchH ₂ O
ACOUSTICAL NOISE (AVG.)	73.0 (MAX. 77.0) dB-A

(continued)

PART NO:

DELTA MODEL: GFB0412ES-E

INSULATION STRENGTH	10 MEG OHM MIN. AT 500 VDC (BETWEEN FRAME AND (+) TERMINAL)
DIELECTRIC STRENGTH	5 mA MAX. AT 500 VAC 50/60 Hz ONE MINUTE, (BETWEEN FRAME AND (+) TERMINAL)
LIFE EXPECTANCE (L10) (AT LABEL VOLTAGE)	30,000 HOURS CONTINUOUS OPERATION AT 55° C WITH 15 ~ 65 %RH.
ROTATION	TWO FANS ROTATE IN COUNTER DIRECTIONS SHOWED IN THE NAME PLATE SIDE
OVER CURRENT SHUT DOWN	THE CURRENT WILL SHUT DOWN,WHEN ROTOR LOCKED AND FIXED.

NOTES:

1. ALL READINGS ARE MEASURED AFTER STABLY WARMING UP THROUGH 10 MINUTES.
2. STANDARD AIR PROPERTY IS AIR AT (Td) 25°C TEMPERATURE, (RH) 65% RELATIVE HUMIDITY , AND (Pb) 760 mmHg BAROMETRIC PRESSURE.
3. THE VALUES WRITTEN IN PARENS , (), ARE LIMITED SPEC.
4. THE CHARACTERS SHOWED IN PAGE 1 IS THE CONDITION OF BOTH FANS RUN.
5. ACOUSTICAL NOISE MEASURING CONDITION:

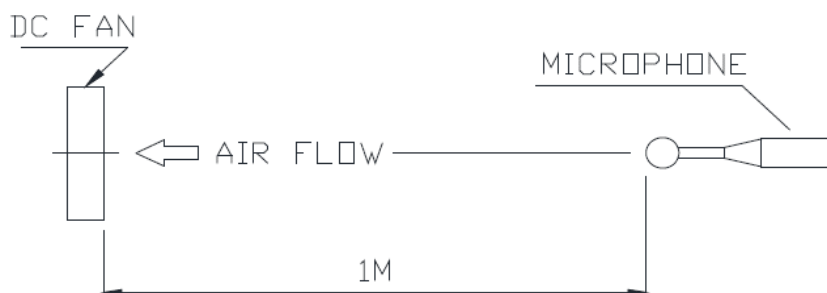

NOISE IS MEASURED AT RATED VOLTAGE IN FREE AIR IN SEMI-ANECHOIC CHAMBER WITH MICROPHONE AT A DISTANCE OF ONE METER FROM THE FAN INTAKE.

PART NO:

DELTA MODEL: GFB0412ES-E

3. MECHANICAL:

- 3-1. DIMENSIONS----- SEE DIMENSIONS DRAWING
- 3-2. FRAME----- PLASTIC UL: 94V-0
- 3-3. IMPELLER----- PLASTIC UL: 94V-0
- 3-4. BEARING SYSTEM----- TWO BALL BEARINGS
- 3-5. WEIGHT----- 110 GRAMS (REF)

4. ENVIRONMENTAL:

- 4-1. OPERATING TEMPERATURE----- -10 TO +70 DEGREE C
- 4-2. STORAGE TEMPERATURE----- -40 TO +75 DEGREE C
- 4-3. OPERATING HUMIDITY----- 5 TO 85 % RH
- 4-4. STORAGE HUMIDITY----- 5 TO 95 % RH

5. PROTECTION:

- 5-1. LOCKED ROTOR PROTECTION
IMPEDANCE OF MOTOR WINDING PROTECTS MOTOR FROM FIRE IN
96 HOURS OF LOCKED ROTOR CONDITION AT THE RATED VOLTAGE.
- 5-2. POLARITY PROTECTION
BE CAPABLE OF WITHSTANDING IF REVERSE CONNECTION FOR
POSITIVE AND NEGATIVE LEADS.
- 5-3. INTERNAL FUSE IMPLEMENTED.

6. RE OZONE DEPLETING SUBSTANCES:

- 6-1. NO CONTAINING PBBs, PBBOs, CFCs, PBBEs, PBDPEs AND HCFCs.

7. PRODUCTION LOCATION

- 7-1. PRODUCTS WILL BE PRODUCED IN CHINA OR THAILAND.

PART NO:

DELTA MODEL: GFB0412ES-E

8. P & Q CURVE:

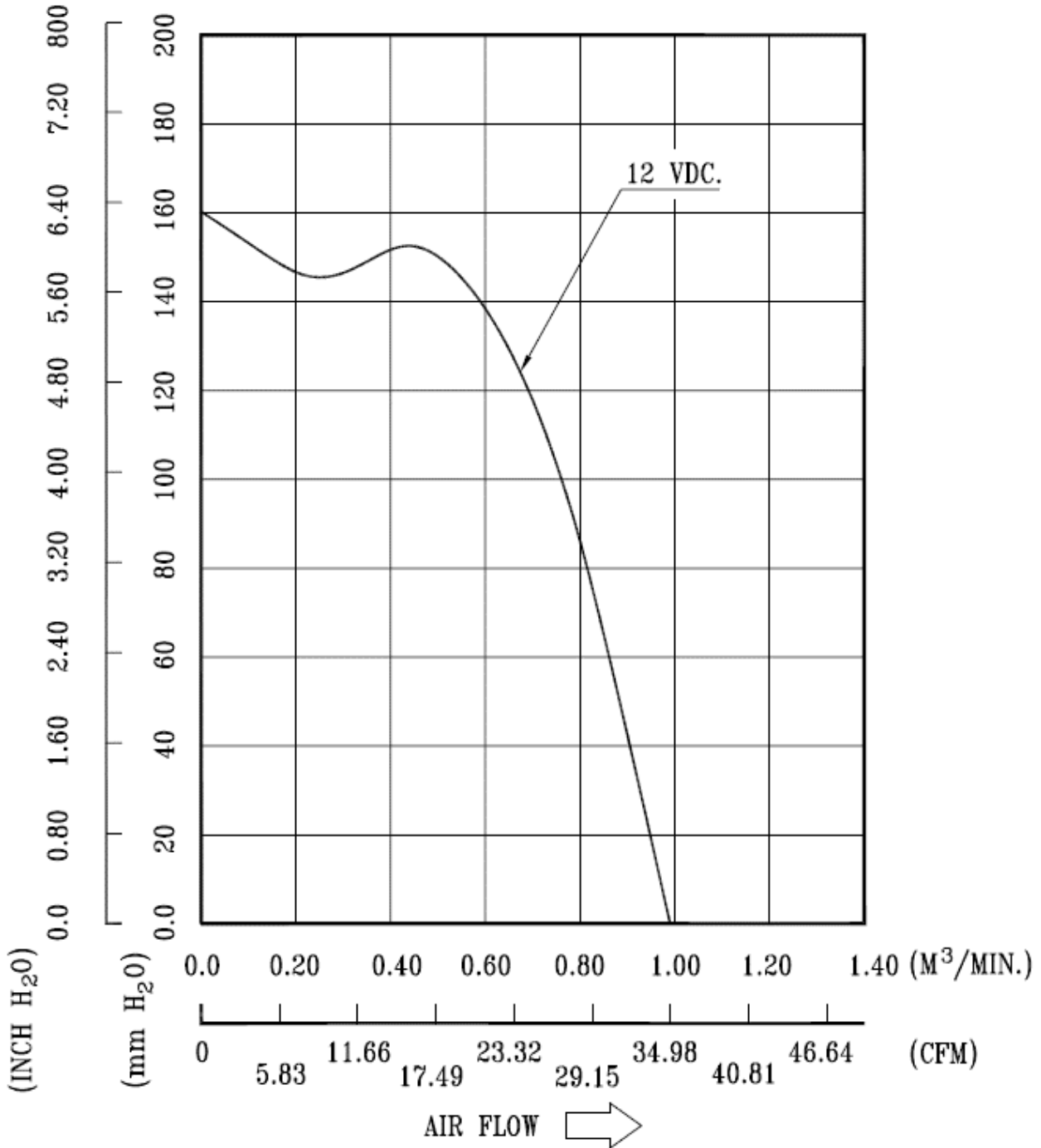

* TEST CONDITION: INPUT VOLTAGE ----- OPERATION VOLTAGE
TEMPERATURE ----- ROOM TEMPERATURE
HUMIDITY ----- 65%RH

PART NO:

DELTA MODEL: GFB0412ES-E

9. DIMENSION DRAWING :

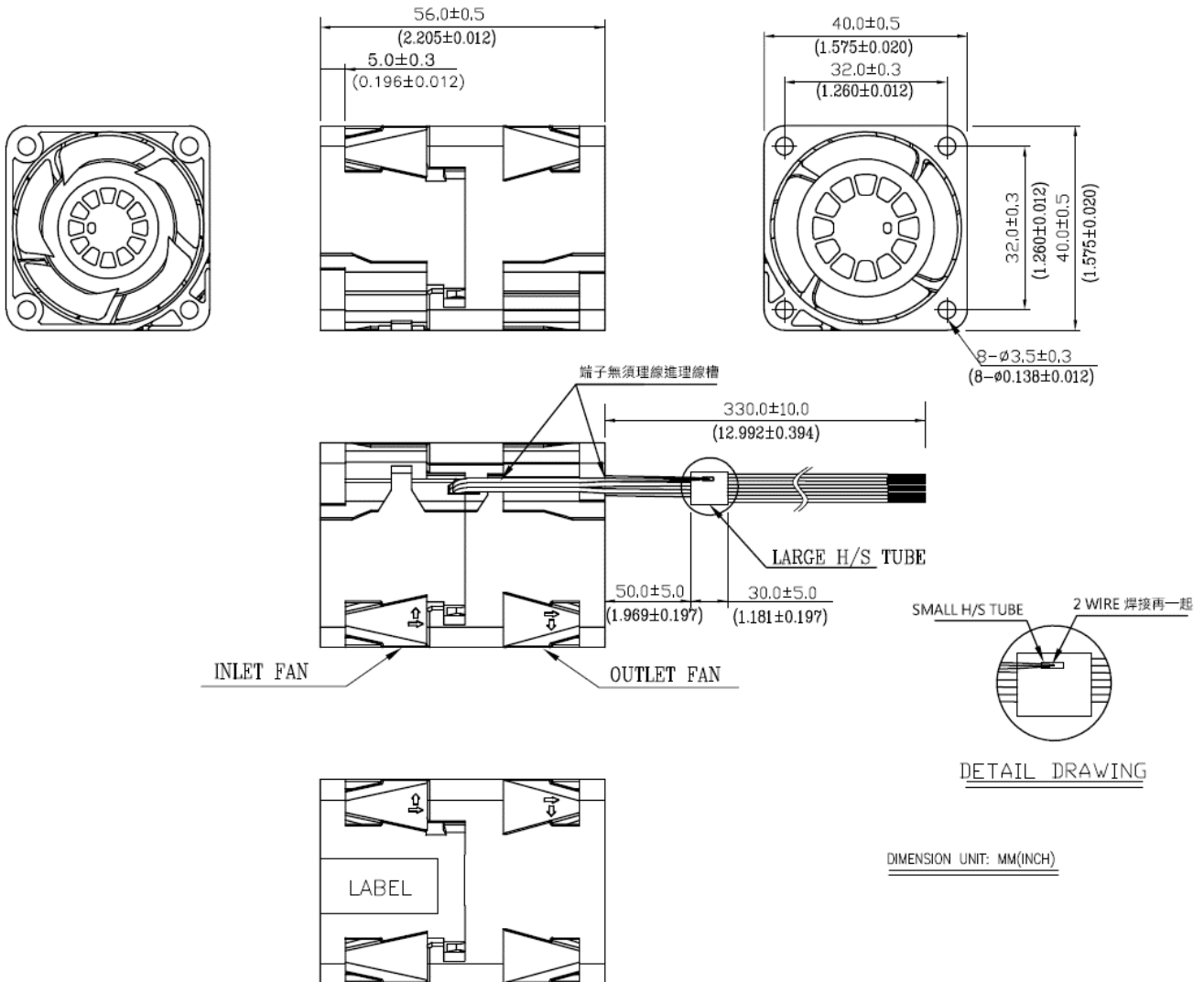
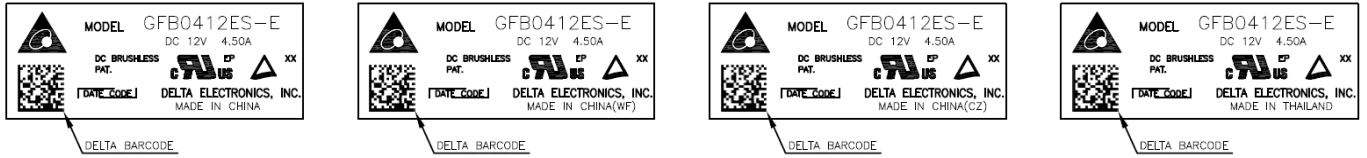

PART NO:

DELTA MODEL: GFB0412ES-E

NOTE:

- 1.LEAD WIRE: UL 10368 -F- AWG #28
GREY WIRE -----(-) OUTLET FAN
BLACK WIRE -----(-) INLET FAN
RED WIRE -----(+) INLET FAN
ORANGE WIRE -----(+) OUTLET FAN
BLUE WIRE -----(PWM) INLET FAN
GREEN WIRE -----(PWM) OUTLET FAN
YELLOW WIRE ----- (F00) INLET FAN
WHITE WIRE -----(F00) OUTLET FAN
- 2.LARGE H/S TUBE: BLACK -----1PCE
- 3.SMALL H/S TUBE: BLACK -----1PCE
- 4.THIS PRODUCT IS RoHS2.0 COMPLIANT

PART NO:

DELTA MODEL: GFB0412ES-E

10. SUBSTANCES AND MATERIALS:

HAZARDOUS SUBSTANCES		ALLOWABLE CONTENT	REMARK
HEAVY METALS	CADMIUM(Cd) AND ITS COMPOUNDS	< 0.01 WT% (<100 PPM)	DIRECTIVE 2011/65/EU
	LEAD(Pb) AND ITS COMPOUNDS	< 0.1 WT% (<1000 PPM)	DIRECTIVE 2011/65/EU
	MERCURY(Hg) AND ITS COMPOUNDS	< 0.1 WT% (<1000 PPM)	DIRECTIVE 2011/65/EU
	HEXAVALENT CHROMIUM (CHROMIUM VI) (Cr6+) AND ITS COMPOUNDS	< 0.1 WT% (<1000 PPM)	DIRECTIVE 2011/65/EU
BROMINATED FLAME RETARDANTS	POLYBROMINATED BIPHENYLS (PBBs)	< 0.1 WT% (<1000 PPM)	DIRECTIVE 2011/65/EU
	POLYBROMINATED DIPHENYLS (PBDEs)	< 0.1 WT% (<1000 PPM)	DIRECTIVE 2011/65/EU
PLASTICIZER	BIS (2-ETHYLHEXYL) PHTHALATE (DEHP)	< 0.1 WT% (<1000 PPM)	DIRECTIVE 2015/863/EU
	BUTYL BENZYL PHTHALATE (BBP)	< 0.1 WT% (<1000 PPM)	DIRECTIVE 2015/863/EU
	DIBUTYL PHTHALATE (DBP)	< 0.1 WT% (<1000 PPM)	DIRECTIVE 2015/863/EU
	DIISOBUTYL PHTHALATE (DIBP)	< 0.1 WT% (<1000 PPM)	DIRECTIVE 2015/863/EU

PART NO:

DELTA MODEL: GFB0412ES-E

11.FREQUENCY GENERATOR (FG) SIGNAL:

11-1. OUTPUT CIRCUIT - OPEN COLLECTOR MODE:

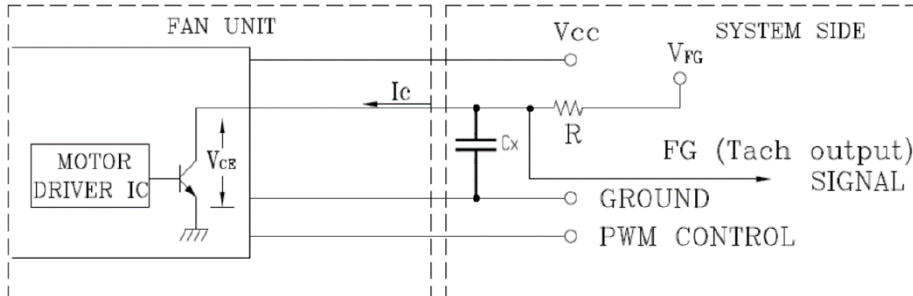

CAUTION:

THE LEAD WIRE OF RD SIGNAL CAN NOT TOUCH THE LEAD WIRE OF POSITIVE OR NEGATIVE.

11-2. SPECIFICATION:

$V_{FG} = 13.2V \text{ MAX.}$

$I_c = 5mA \text{ MAX.}$

$V_{CE} = 0.5V \text{ MAX.}$

$R \geq V_{FG} / I_c$

11-3. FREQUENCY GENERATOR WAVEFORM:

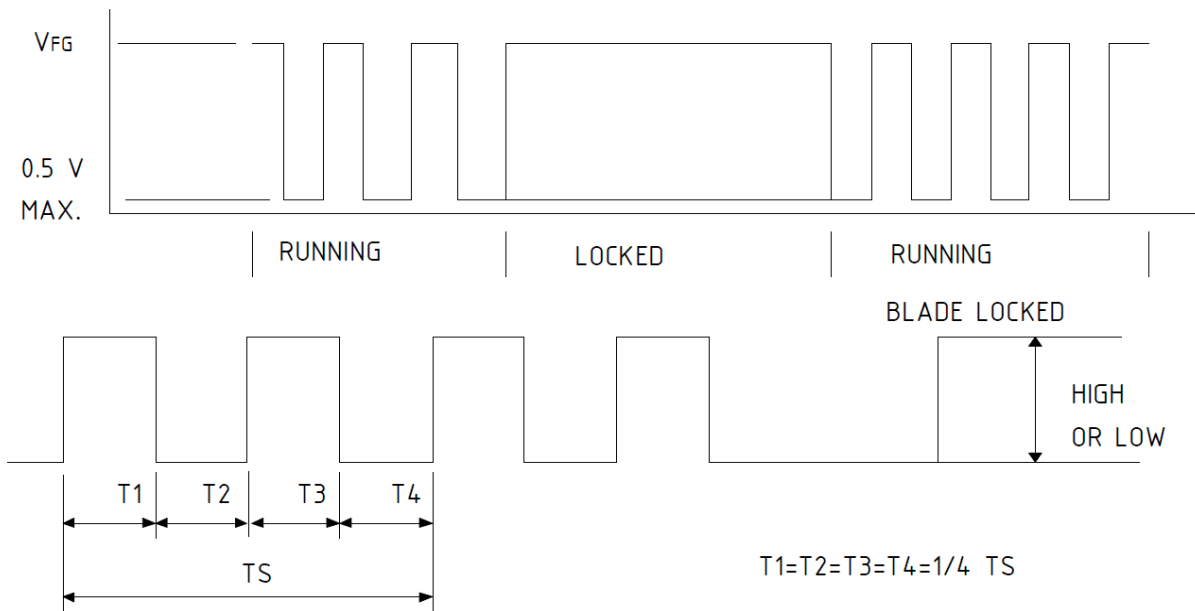

$N=R.P.M$

$TS=60/N(\text{SEC})$

*VOLTAGE LEVEL AFTER BLADE LOCKED

*4 POLES

PART NO:

DELTA MODEL: GFB0412ES-E

12. PWM CONTROL SIGNAL (NEGATIVE DUTY CYCLE)

SIGNAL VOLTAGE RANGE: 0~15.0VDC

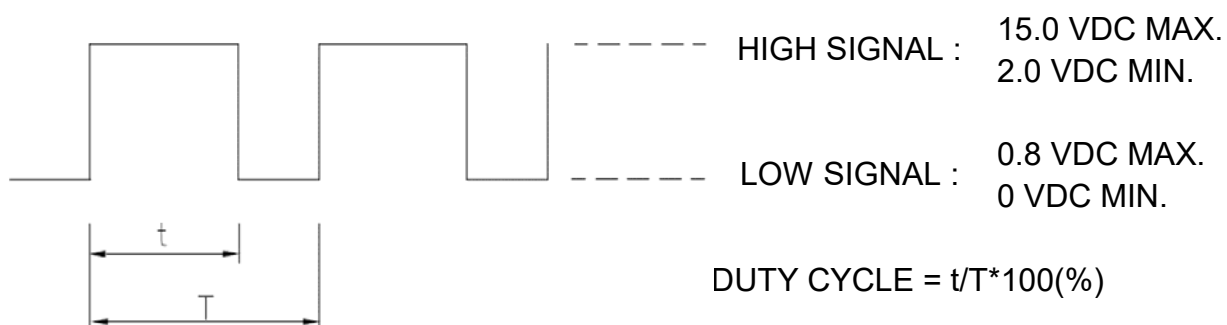

*THE PREFERRED OPERATING POINT FOR THE FAN IS 25K HZ.

*AT 100% DUTY CYCLE, THE ROTOR WILL SPIN AT MAXIMUM SPEED.

*AT 0% DUTY CYCLE, THE ROTOR WILL SPIN AT MINIMUM SPEED.

*WITH CONTROL SIGNAL LEAD DISCONNECTED, THE FAN WILL SPIN AT MAXIMUM SPEED.

*WHEN THE INLET FAN WILL FAIL, THE OUTFAN WILL EXECUT THE TURO MODE.

*THE FAN SPEED CONTROL IS CLOSE LOOP

13. SPEED VS PWM CONTROL SIGNAL:

(AT RATED VOLTAGE & PWM FREQUENCY=25KHZ)

DUTY CYCLE (%)	SPEED R.P.M. (REF.)		CURRENT (A) TYP. TOTAL
	INLET	OUTLET	
100	29500±10%	26500±10%	3.25
50	17000±10%	15300±10%	0.75
0	2950±400	3200±500	0.12
TURO	FAIL	32000±10%	2.00

14. PWM CONTROL LEAD WIRE INPUT IMPEDANCE:

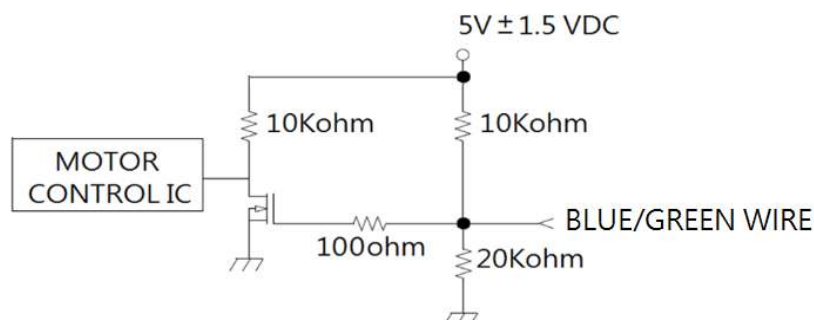

14-1. THE FAN SPEED WILL DEFAULT TO MAXIMUM WHEN THE SPEED CONTROL INPUT IS LEFT UNCONNECTED.



Application Notice

- 1. Delta will not guarantee the performance of the products if the application condition falls outside the parameters set forth in the specification.**
- 2. A written request should be submitted to Delta prior to approval if deviation from this specification is required.**
- 3. Please exercise caution when handling fans. Damage may be caused when pressure is applied to the impeller, if the fans are handled by the lead wires, or if the fan was hard-dropped to the production floor.**
- 4. Except as pertains to some special designs, there is no guarantee that the products will be free from any such safety problems or failures as caused by the introduction of powder, droplets of water or encroachment of insect into the hub.**
- 5. The above-mentioned conditions are representative of some unique examples and viewed as the first point of reference prior to all other information.**
- 6. It is very important to establish the correct polarity before connecting the fan to the power source. Positive (+) and Negative (-). Damage may be caused to the fans if connection is with reverse polarity, if there is no foolproof method to protect against such error specifically mentioned in this spec.**
- 7. Delta fans without special protection are not suitable where any corrosive fluids are introduced to their environment.**
- 8. Please ensure all fans are stored according to the storage temperature limits specified. Do not store fans in a high humidity environment. We highly recommend performance testing is conducted before shipping, if the fans have been stored over 6 months.**
- 9. Not all fans are provided with the Lock Rotor Protection feature. If you impair the rotation of the impeller for the fans that do not have this function, the performance of those fans will lead to failure.**
- 10. Please be cautious when mounting the fan. Incorrect mounting of fans may cause excess resonance, vibration and subsequent noise.**
- 11. It is important to consider safety when testing the fans. A suitable fan guard should be fitted to the fan to guard against any potential for personal injury.**
- 12. Except where specifically stated, all tests are carried out at room (ambient) temperature and relative humidity conditions of 25°C, 65% RH. The test value is only for fan performance itself.**
- 13. Be certain to connect an “ 4.7μF or greater” capacitor to the fan externally when the application calls for using multiple fans in parallel, to avoid any unstable power.**