

THIS DRAWING IS UNPUBLISHED.      RELEASED FOR PUBLICATION      20

© COPYRIGHT 20      BY TYCO ELECTRONICS CORPORATION. ALL RIGHTS RESERVED.

LOC	DIST	REVISIONS					
		P	LTR	DESCRIPTION	DATE	DWN	APVD
CM	00		0	REVISED PER 063B-0280-03	07AUG2003	KW	JE

1. VERIFICATION TEST SPEC. 502-1136.
2. FOR USE WITH AMP-TAPETRONIC™ MACHINE 68250-1 (DIE 68344-1 REQUIRED).

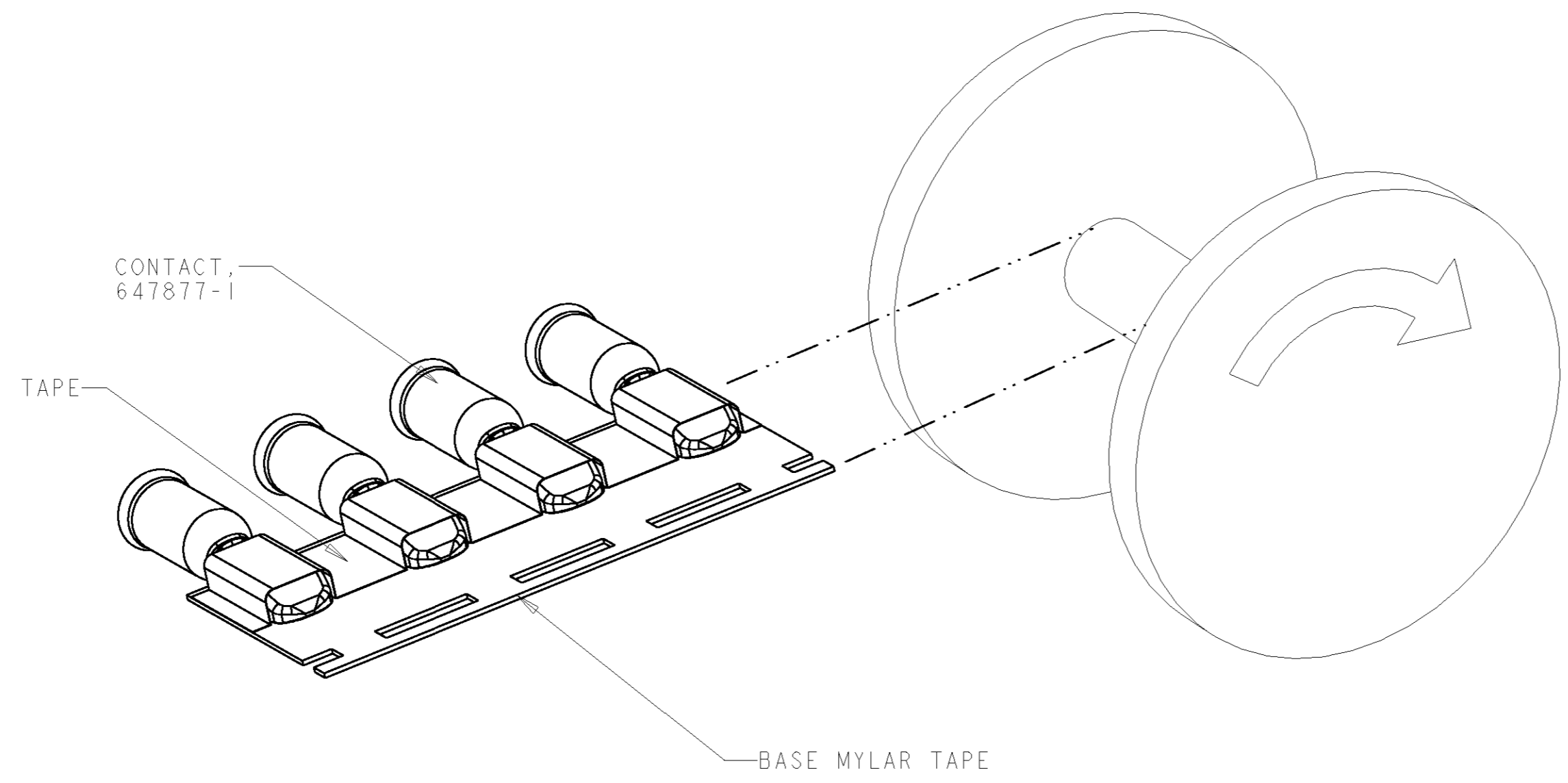

647754-1  
PART NUMBER

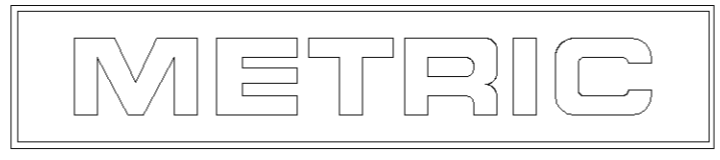

<small>THIS DRAWING IS A CONTROLLED DOCUMENT FOR TYCO ELECTRONICS CORPORATION. IT IS SUBJECT TO CHANGE AND THE CONTROLLING ENGINEERING ORGANIZATION SHOULD BE CONTACTED FOR THE LATEST REVISION.</small>		DWN K. WHITAKER 07AUG2003 CHK J. ELLIS 07AUG2003 APVD J. ELLIS 07AUG2003	<b>tyco</b> <i>Electronics</i> Tyco Electronics Harrisburg, PA 17105-3608
DIMENSIONS: mm [ INCHES ]	TOLERANCES UNLESS OTHERWISE SPECIFIED: 0 PLC ± 1 PLC ± 2 PLC ±0.13 [ .005 ] 3 PLC ± 4 PLC ± ANGLES ± FINISH	PRODUCT SPEC - APPLICATION SPEC - WEIGHT -	NAME CONTACT, 6 AWG, TAPE AND REEL, AMP POWER SERIES 50 SIZE A2 CAGE CODE 00779 DRAWING NO 647754 RESTRICTED TO -
MATERIAL COPPER	FINISH SILVER	CUSTOMER DRAWING	SCALE 2:1 SHEET 1 OF 1 REV 0