



ARM Cortex<sup>®</sup>-M0

32-BIT MICROCONTROLLER

## NuTiny-SDK-NUC140 User Manual For NuMicro<sup>™</sup> NUC140 Series

*The information described in this document is the exclusive intellectual property of Nuvoton Technology Corporation and shall not be reproduced without permission from Nuvoton.*

*Nuvoton is providing this document only for reference purposes of NuMicro<sup>™</sup> microcontroller based system design. Nuvoton assumes no responsibility for errors or omissions.*

*All data and specifications are subject to change without notice.*

*For additional information or questions, please contact: Nuvoton Technology Corporation.*



1	Overview.....	3
2	NuTiny-SDK-NUC140 Introduction .....	3
2.1	NuTiny-SDK-NUC140 Jumper Description .....	4
2.2	Pin Assignment for Extended Connector .....	5
2.3	NuTiny-SDK-NUC140 PCB Placement .....	6
3	How to Start NuTiny-SDK-NUC140 on the Keil $\mu$ Vision <sup>®</sup> IDE.....	7
3.1	Keil uVision <sup>®</sup> IDE Software Download and Install .....	7
3.2	Nuvoton Nu-Link Driver Download and Install .....	7
3.3	Hardware Setup .....	7
3.4	Smpl_NuTiny-NUC140 Example Program .....	8
4	How to Start NuTiny-SDK-NUC140 on the IAR Embedded Workbench .....	9
4.1	IAR Embedded Workbench Software Download and Install.....	9
4.2	Nuvoton Nu-Link Driver Download and Install .....	9
4.3	Hardware Setup .....	9
4.4	Smpl_NuTiny-NUC140 Example Program .....	10
5	NuTiny-EVB-NUC140 Schematic .....	11
6	Download NuMicro <sup>™</sup> Family Related Files from Nuvoton Company .....	13
6.1	Download NuMicro <sup>™</sup> Keil $\mu$ Vision <sup>®</sup> IDE Driver.....	13
6.2	Download NuMicro <sup>™</sup> IAR EWARM Driver.....	15
6.3	Download NuMicro <sup>™</sup> NUC100 Series BSP Software Library.....	17
7	Revision History.....	18

## 1 Overview

NuTiny-SDK-NUC140 is the specific development tool for NuMicro NUC140 series. Users can use NuTiny-SDK-NUC140 to develop and verify the application program easily.

NuTiny-SDK-NUC140 includes two portions. One is NuTiny-EVB-NUC140 and the other is Nu-Link-Me. NuTiny-EVB-NUC140 is the evaluation board and Nu-Link-Me is its Debug Adaptor. Thus, users do not need other additional ICE or debug equipments.

## 2 NuTiny-SDK-NUC140 Introduction

NuTiny-SDK-NUC140 uses the NUC140VE3AN as the target microcontroller. Figure 2-1 is NuTiny-SDK-NUC140 for NUC140 series, the left portion is called NuTiny-EVB-NUC140 and the right portion is Debug Adaptor called Nu-Link-Me.

NuTiny-EVB-NUC140 is similar to other development boards. Users can use it to develop and verify applications to emulate the real behavior. The on board chip covers NUC140 series features. The NuTiny-EVB-NUC140 can be a real system controller to design users' target systems.

Nu-Link-Me is a Debug Adaptor. **The Nu-Link-Me Debug Adaptor connects your PC's USB port to your target system (via Serial Wired Debug Port) and allows you to program and debug embedded programs on the target hardware.** To use Nu-Link-Me Debug adaptor with IAR or Keil, please refer to “Nuvoton NuMicro™ IAR ICE driver user manual “or Nuvoton NuMicro™ Keil ICE driver user manual” in detail. These two documents will be stored in the local hard disk when the user installs each driver.

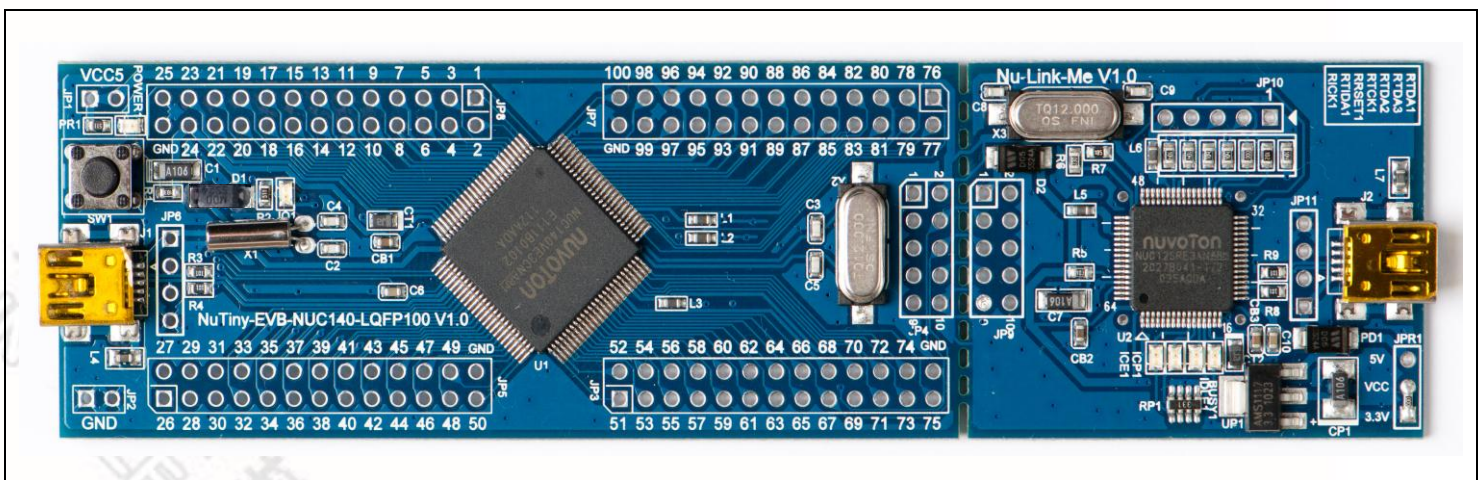

Figure 2-1 NuTiny-SDK-NUC140 (Blue PCB Board)

## 2.1 NuTiny-SDK-NUC140 Jumper Description

### 2.1.1 Power Setting

- J1: USB port in NuTiny-EVB-NUC140
- JP1: VCC5 Voltage connector in NuTiny-EVB-NUC140
- J2: USB port in Nu-Link-Me
- JPR1: Select 5V or 3V for system power

POWER model	J1 USB port	J2 USB port	JP1 VCC5	MCU Voltage
Model 1	Connect to PC	X	DC 5V output	DC 5V
Model 2	X	Connect to PC	DC 5V output	DC 5V
Model 3	X	X	DC 2.8-5.5V input	Voltage by VCC input

X: Unused.

### 2.1.2 Debug Connector

- JP4: Connector in target board (NuTiny-EVB-NUC140) for connecting with Nuvoton ICE adaptor (Nu-Link-Me)
- JP9: Connector in ICE adaptor (Nu-Link-Me) for connecting with a target board (for example NuTiny-EVB-NUC140)

### 2.1.3 USB Connector

- J1: Mini USB Connector in NuTiny-EVB-100 for application use
- J2: Mini USB Connector in Nu-Link-Me connected to a PC USB port

### 2.1.4 Extended Connector

- JP3, JP5, JP7 and JP8: Show all chip pins in NuTiny-EVB-NUC140

### 2.1.5 Reset Button

- SW1: Reset button in NuTiny-EVB-NUC140

### 2.1.6 Power Connector

- JP1: VCC connector in NuTiny-EVB-NUC140
- JP2: GND connector in NuTiny-EVB-NUC140

## 2.2 Pin Assignment for Extended Connector

NuTiny-EVB-NUC140 provides NUC140VE3AN on board and the extended connector for LQFP-100 pin. Table 2-1 is the pin assignment for NUC140VE3AN.

Pin No	Pin Name	Pin No	Pin Name	Pin No	Pin Name	Pin No	Pin Name
01	PE15	26	PE8	51	PE4	76	PA5
02	PE14	27	PE7	52	PE3	77	PA6
03	PE13	28	VBUS	53	PE2	78	PA7
04	PB14	29	VDD33	54	PE1	79	Vref
05	PB13	30	D-	55	PE0	80	AVDD
06	PB12	31	D+	56	PC13	81	PD0
07	X32O	32	PB0	57	PC12	82	PD1
08	X32I	33	PB1	58	PC11	83	PD2
09	PA11	34	PB2	59	PC10	84	PD3
10	PA10	35	PB3	60	PC9	85	PD4
11	PA9	36	PD6	61	PC8	86	PD5
12	PA8	37	PD7	62	PA15	87	PC7
13	PD8	38	PD14	63	PA14	88	PC6
14	PD9	39	PD15	64	PA13	89	PC15
15	PD10	40	PC5	65	PA12	90	PC14
16	PD11	41	PC4	66	ICE_DAT	91	PB15
17	PD12	42	PC3	67	ICE_CK	92	XT1_Out
18	PD14	43	PC2	68	VDD	93	XT1_In
19	PB4	44	PC1	69	VSS	94	/RESET
20	PB5	45	PC0	70	AVSS	95	VSS
21	PB6	46	PE6	71	PA0	96	VDD
22	PB7	47	PE5	72	PA1	97	PS2DAT
23	LDO	48	PB11	73	PA2	98	PS2CLK
24	VDD	49	PB10	74	PA3	99	PVSS
25	VSS	50	PB9	75	PA4	100	PB8

Table 2-1 Pin Assignment for NUC 140 Series



### 3 How to Start NuTiny-SDK-NUC140 on the Keil $\mu$ Vision<sup>®</sup> IDE

#### 3.1 Keil $\mu$ Vision<sup>®</sup> IDE Software Download and Install

Please visit the Keil company website (<http://www.keil.com>) to download the Keil  $\mu$ Vision<sup>®</sup> IDE and install the RVMDK.

#### 3.2 Nuvoton Nu-Link Driver Download and Install

Please visit the Nuvoton company NuMicro<sup>™</sup> website (<http://www.nuvoton.com/NuMicro>) to download “NuMicro<sup>™</sup> Keil  $\mu$ Vision<sup>®</sup> IDE driver” file. Please refer to Chapter 6.1 for the detail download flow. When the Nu-Link driver has been well downloaded, please unzip the file and execute the “Nu-Link\_Keil\_Driver.exe” to install the driver.

#### 3.3 Hardware Setup

The hardware setup is shown as Figure 3-1



Figure 3-1 NuTiny-SDK-NUC140 Hardware Setup

## 3.4 SmpL\_NuTiny-NUC140 Example Program

This example demonstrates the ease of downloading and debugging an application on a NuTiny-SDK-NUC140 board. It can be found on Figure 3-2 list directory and downloaded from Nuvoton NuMicro™ website following on Chapter 6.3.

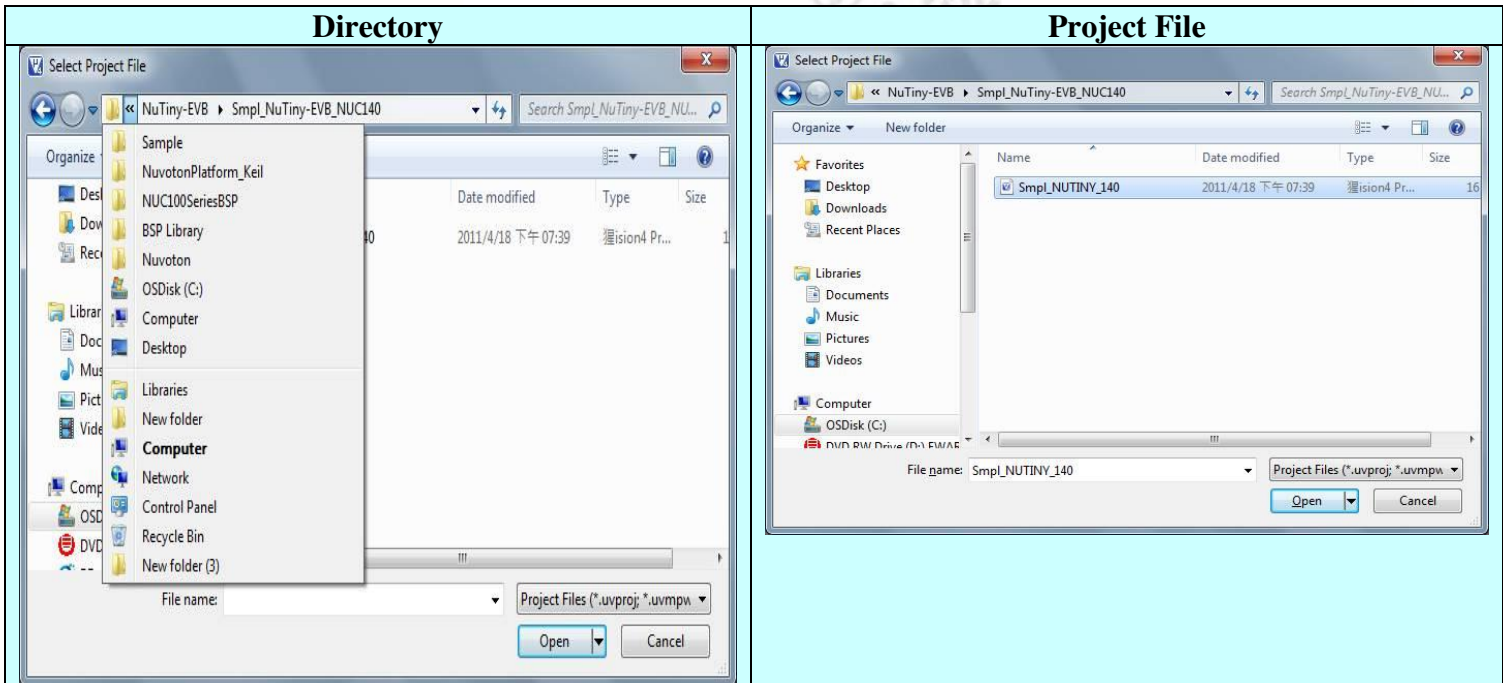









Figure 3-2 SmpL\_NuTiny\_140 Example Directory

To use this example:

The PA.11 LED will toggle on the NuTiny-EVB-NUC140 board.

-  **Start µVision®**
- **Project-Open**  
Open the SmpL\_NuTiny\_100.uvproj project file
-  **Project - Build**  
Compile and link the SmpL\_NuTiny-NUC100 application
-  **Flash – Download**  
Program the application code into on-chip Flash ROM
-  **Start debug mode**  
Using the debugger commands, you may:
  - ◆  Review variables in the watch window
  - ◆  Single step through code
  - ◆  RST Reset the device
  - ◆  Run the application



## 4 How to Start NuTiny-SDK-NUC140 on the IAR Embedded Workbench

### 4.1 IAR Embedded Workbench Software Download and Install

Please connect to IAR company website (<http://www.iar.com>) to download the IAR Embedded Workbench and install the EWARM.

### 4.2 Nuvoton Nu-Link Driver Download and Install

Please connect to the Nuvoton Company NuMicro™ website (<http://www.nuvoton.com/NuMicro>) to download “NuMicro™ IAR ICE driver user manual” file. Please refer to Chapter 6.2 for the detail download flow. When the Nu-Link driver has been well downloaded, please unzip the file and execute the “Nu-Link\_IAR\_Driver.exe” to install the driver.

### 4.3 Hardware Setup

The hardware setup is shown as Figure 4-1



Figure 4-1 NuTiny- SDK-NUC140 Hardware Setup

## 4.4 Smp1\_NuTiny-NUC140 Example Program

This example demonstrates the ease of downloading and debugging an application on a NuTiny-SDK-NUC140 board. It can be found on Figure 4-2 list directory and downloaded from Nuvoton NuMicro™ website following on Chapter 6.3.

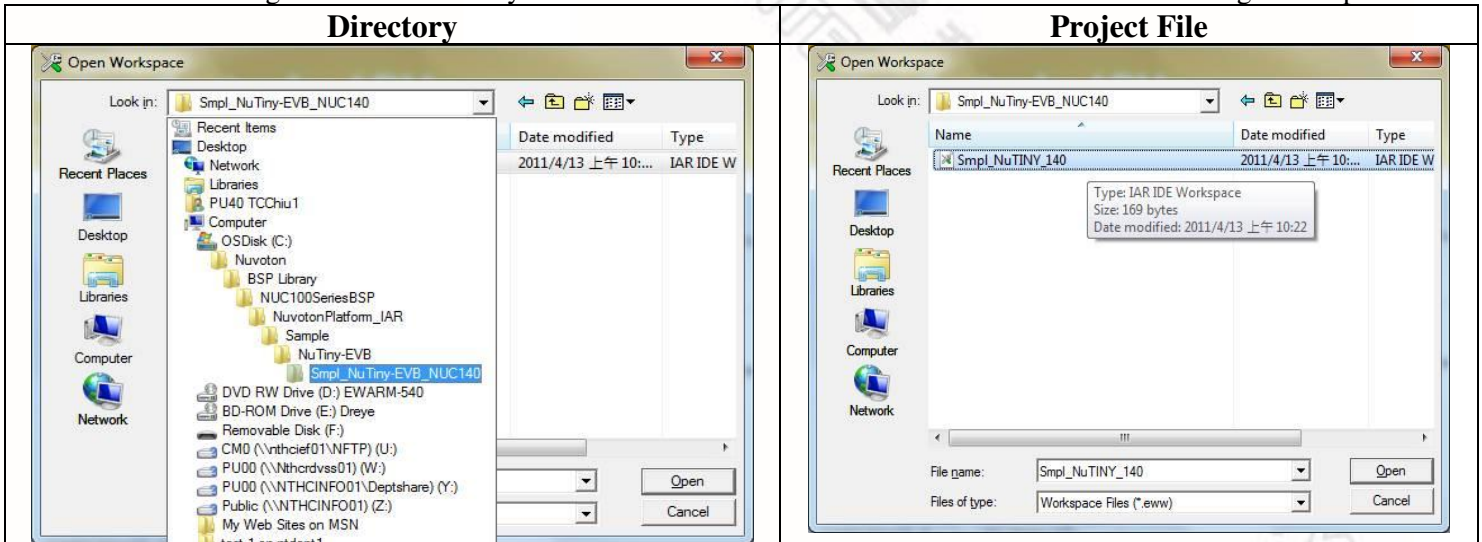

Figure 4-2 Smp1\_NuTiny-NUC140 Example Directory

To use this example:

The PB.0 LED will toggle on the NuTiny-EVB-NUC140 board.

- **Start IAR Embedded Workbench**

- **File-Open-Workspace**  
Open the Smp1\_NuTiny\_100.eww workspace file

- **Project - Make**  
Compile and link the Smp1\_NuTiny-100 application

- **Project – Download and Debug**  
Program the application code into on-chip Flash ROM.

- ◆ Single step through code
- ◆ Reset the device
- ◆ Run the application

## 5 NuTiny-EVB-NUC140 Schematic

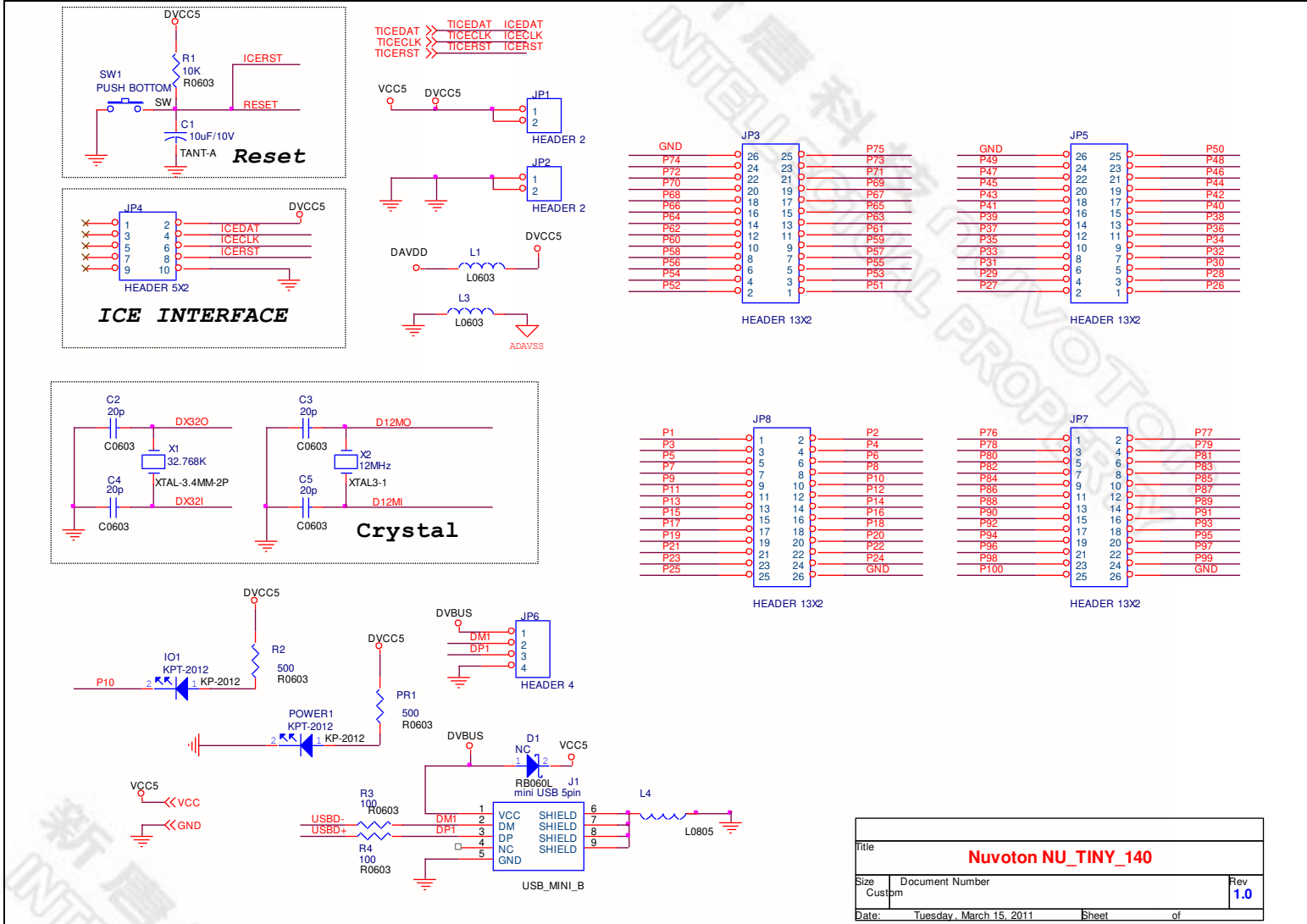

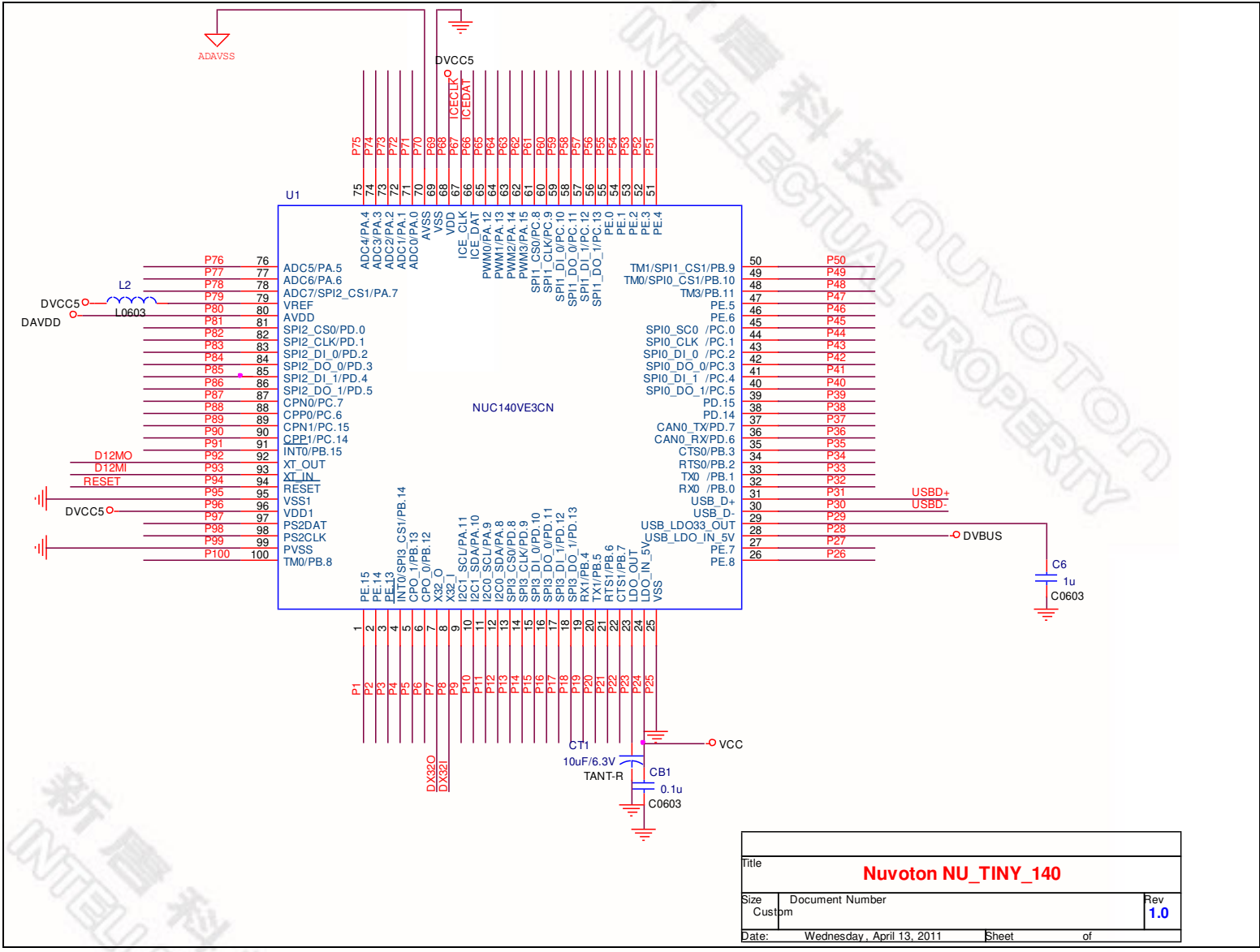

## 6 Download NuMicro™ Family Related Files from Nuvoton Company

### 6.1 Download NuMicro™ Keil μVision® IDE Driver

<p><b>Step1</b></p>	<p>Visit the Nuvoton NuMicro™ website: <a href="http://www.nuvoton.com/NuMicro">http://www.nuvoton.com/NuMicro</a></p>
<p><b>Step2</b></p>	<p>The screenshot shows the Nuvoton website homepage. The navigation bar includes 'Products', 'Applications', 'Support', 'Foundry Service', 'Buy', 'myNuvoton', and 'About Nuvoton'. The 'Support' dropdown menu is open, showing options like 'Learning', 'Product Related Information', 'Tool &amp; Software', 'Reference Design', 'FAQ', 'Sales Support', 'Technical Support', and 'Forum'. The 'Tool &amp; Software' option is highlighted with a red dashed box. A yellow callout bubble with a red arrow points to this option, containing the text: "Click here to enter Tool &amp; Software."</p>
<p><b>Step3</b></p>	<p>The screenshot shows the 'Development Tool Hardware' page on the Nuvoton website. The left sidebar contains a list of links: 'Learning', 'Product Related Information', 'Tool &amp; Software', 'Development Tool Hardware', 'Development Kit', 'Learning Board', 'Programmer', 'Software', 'Third Party Tool', 'Reference Design', 'FAQ', 'Sales Support', 'Technical Support', and 'Forum'. The 'Software' link is highlighted with a red dashed box. A yellow callout bubble with a red arrow points to this link, containing the text: "Click here to enter Device Driver and Software Library."</p>

<b>Step4</b>	<p><i>Programmer Software Tools Package</i></p> <table border="1"> <thead> <tr> <th>File name</th> <th>Description</th> <th>Version</th> <th>Date</th> </tr> </thead> <tbody> <tr> <td>  ICP Programming Tool V1.25.6287.zip   Revision History                 </td> <td>NuMicro ICP tool &amp; user manual</td> <td>V1.25.6287</td> <td>2014-01-16</td> </tr> <tr> <td>  ISP Programming Tool V1.44.zip   Revision History                 </td> <td>NuMicro ISP Programming Tool &amp; user manual</td> <td>V1.44</td> <td>2014-01-20</td> </tr> <tr> <td>  NuGang Programmer V6.21.zip   Revision History                 </td> <td>NuGang Programmer software &amp; user manual</td> <td>V6.21</td> <td>2014-01-24</td> </tr> </tbody> </table> <p><i>Nu-Link Driver</i></p> <table border="1"> <thead> <tr> <th>File name</th> <th>Description</th> <th>Version</th> <th>Date</th> </tr> </thead> <tbody> <tr> <td>  Nu-Link Driver for Keil RVMDK V1.25.6287.zip   Revision History                 </td> <td>This driver is to support Nu-Link to work under Keil RVMDK Development Environment for all NuMicro Family Devices.</td> <td>V1.25.6287</td> <td>2014-01-16</td> </tr> <tr> <td>  Nu-Link Driver for IAR EWARM V1.25.6287.zip   Revision History                 </td> <td>This driver is to support Nu-Link to work under IAR EWARM Development Environment for all NuMicro Family Devices.</td> <td>V1.25.6287</td> <td>2014-01-16</td> </tr> </tbody> </table> <p style="text-align: center;"> </p> <p style="text-align: right;">  User Feedback    ↑ TOP                 </p>	File name	Description	Version	Date	ICP Programming Tool V1.25.6287.zip Revision History	NuMicro ICP tool & user manual	V1.25.6287	2014-01-16	ISP Programming Tool V1.44.zip Revision History	NuMicro ISP Programming Tool & user manual	V1.44	2014-01-20	NuGang Programmer V6.21.zip Revision History	NuGang Programmer software & user manual	V6.21	2014-01-24	File name	Description	Version	Date	Nu-Link Driver for Keil RVMDK V1.25.6287.zip Revision History	This driver is to support Nu-Link to work under Keil RVMDK Development Environment for all NuMicro Family Devices.	V1.25.6287	2014-01-16	Nu-Link Driver for IAR EWARM V1.25.6287.zip Revision History	This driver is to support Nu-Link to work under IAR EWARM Development Environment for all NuMicro Family Devices.	V1.25.6287	2014-01-16
	File name	Description	Version	Date																									
ICP Programming Tool V1.25.6287.zip Revision History	NuMicro ICP tool & user manual	V1.25.6287	2014-01-16																										
ISP Programming Tool V1.44.zip Revision History	NuMicro ISP Programming Tool & user manual	V1.44	2014-01-20																										
NuGang Programmer V6.21.zip Revision History	NuGang Programmer software & user manual	V6.21	2014-01-24																										
File name	Description	Version	Date																										
Nu-Link Driver for Keil RVMDK V1.25.6287.zip Revision History	This driver is to support Nu-Link to work under Keil RVMDK Development Environment for all NuMicro Family Devices.	V1.25.6287	2014-01-16																										
Nu-Link Driver for IAR EWARM V1.25.6287.zip Revision History	This driver is to support Nu-Link to work under IAR EWARM Development Environment for all NuMicro Family Devices.	V1.25.6287	2014-01-16																										
<b>Step5</b>	Download the NuMicro™ Keil μVision® IDE driver.																												

新唐科技 NUVOTON  
 INTELLECTUAL PROPERTY



## 6.2 Download NuMicro™ IAR EWARM Driver

<p><b>Step1</b></p>	<p>Visit the Nuvoton NuMicro™ website: <a href="http://www.nuvoton.com/NuMicro">http://www.nuvoton.com/NuMicro</a>.</p>
<p><b>Step2</b></p>	<p>The screenshot shows the Nuvoton website homepage. The navigation bar includes 'Products', 'Applications', 'Support', 'Foundry Service', 'Buy', 'myNuvoton', and 'About Nuvoton'. The 'Support' dropdown menu is open, showing options like 'Learning', 'Product Related Information', 'Tool &amp; Software', 'Reference Design', 'FAQ', 'Sales Support', 'Technical Support', and 'Forum'. 'Tool &amp; Software' is highlighted with a red dashed box. A yellow callout bubble with a red arrow points to this menu item, containing the text: "Click here to enter Tool &amp; Software."</p>
<p><b>Step3</b></p>	<p>The screenshot shows the 'Development Tool Hardware' page on the Nuvoton website. The left sidebar contains a 'Software' link highlighted with a red dashed box. A yellow callout bubble with a red arrow points to this link, containing the text: "Click here to enter Device Driver and Software Library." The main content area features a diagram of development and production processes, including 'Code Development', 'Mass Production', and 'Upgrade' stages.</p>

<b>Step4</b>	<p><i>Programmer Software Tools Package</i></p> <table border="1"> <thead> <tr> <th>File name</th> <th>Description</th> <th>Version</th> <th>Date</th> </tr> </thead> <tbody> <tr> <td>  ICP Programming Tool V1.25.6287.zip   Revision History                 </td> <td>NuMicro ICP tool &amp; user manual</td> <td>V1.25.6287</td> <td>2014-01-16</td> </tr> <tr> <td>  ISP Programming Tool V1.44.zip   Revision History                 </td> <td>NuMicro ISP Programming Tool &amp; user manual</td> <td>V1.44</td> <td>2014-01-20</td> </tr> <tr> <td>  NuGang Programmer V6.21.zip   Revision History                 </td> <td>NuGang Programmer software &amp; user manual</td> <td>V6.21</td> <td>2014-01-24</td> </tr> </tbody> </table> <p><i>Nu-Link Driver</i></p> <table border="1"> <thead> <tr> <th>File name</th> <th>Description</th> <th>Version</th> <th>Date</th> </tr> </thead> <tbody> <tr> <td>  Nu-Link Driver for Keil RVMDK V1.25.6287.zip   Revision History                 </td> <td>This driver is to support Nu-Link to work under Keil RVMDK Development Environment for all NuMicro Family Devices.</td> <td>V1.25.6287</td> <td>2014-01-16</td> </tr> <tr> <td> <div style="border: 1px dashed red; padding: 2px;">  Nu-Link Driver for IAR EWARM V1.25.6287.zip   Revision History                 </div> </td> <td>This driver is to support Nu-Link to work under IAR EWARM Development Environment for all NuMicro Family Devices.</td> <td>V1.25.6287</td> <td>2014-01-16</td> </tr> </tbody> </table> <div style="text-align: right; margin-top: 10px;">  User Feedback ↑ TOP                 </div>	File name	Description	Version	Date	ICP Programming Tool V1.25.6287.zip Revision History	NuMicro ICP tool & user manual	V1.25.6287	2014-01-16	ISP Programming Tool V1.44.zip Revision History	NuMicro ISP Programming Tool & user manual	V1.44	2014-01-20	NuGang Programmer V6.21.zip Revision History	NuGang Programmer software & user manual	V6.21	2014-01-24	File name	Description	Version	Date	Nu-Link Driver for Keil RVMDK V1.25.6287.zip Revision History	This driver is to support Nu-Link to work under Keil RVMDK Development Environment for all NuMicro Family Devices.	V1.25.6287	2014-01-16	<div style="border: 1px dashed red; padding: 2px;">  Nu-Link Driver for IAR EWARM V1.25.6287.zip   Revision History                 </div>	This driver is to support Nu-Link to work under IAR EWARM Development Environment for all NuMicro Family Devices.	V1.25.6287	2014-01-16
	File name	Description	Version	Date																									
ICP Programming Tool V1.25.6287.zip Revision History	NuMicro ICP tool & user manual	V1.25.6287	2014-01-16																										
ISP Programming Tool V1.44.zip Revision History	NuMicro ISP Programming Tool & user manual	V1.44	2014-01-20																										
NuGang Programmer V6.21.zip Revision History	NuGang Programmer software & user manual	V6.21	2014-01-24																										
File name	Description	Version	Date																										
Nu-Link Driver for Keil RVMDK V1.25.6287.zip Revision History	This driver is to support Nu-Link to work under Keil RVMDK Development Environment for all NuMicro Family Devices.	V1.25.6287	2014-01-16																										
<div style="border: 1px dashed red; padding: 2px;">  Nu-Link Driver for IAR EWARM V1.25.6287.zip   Revision History                 </div>	This driver is to support Nu-Link to work under IAR EWARM Development Environment for all NuMicro Family Devices.	V1.25.6287	2014-01-16																										
<b>Step5</b>	Download the NuMicro™ IAR EWARM driver.																												

Click here to download the file.

新唐科技 NUVOTON  
 INTELLECTUAL PROPERTY

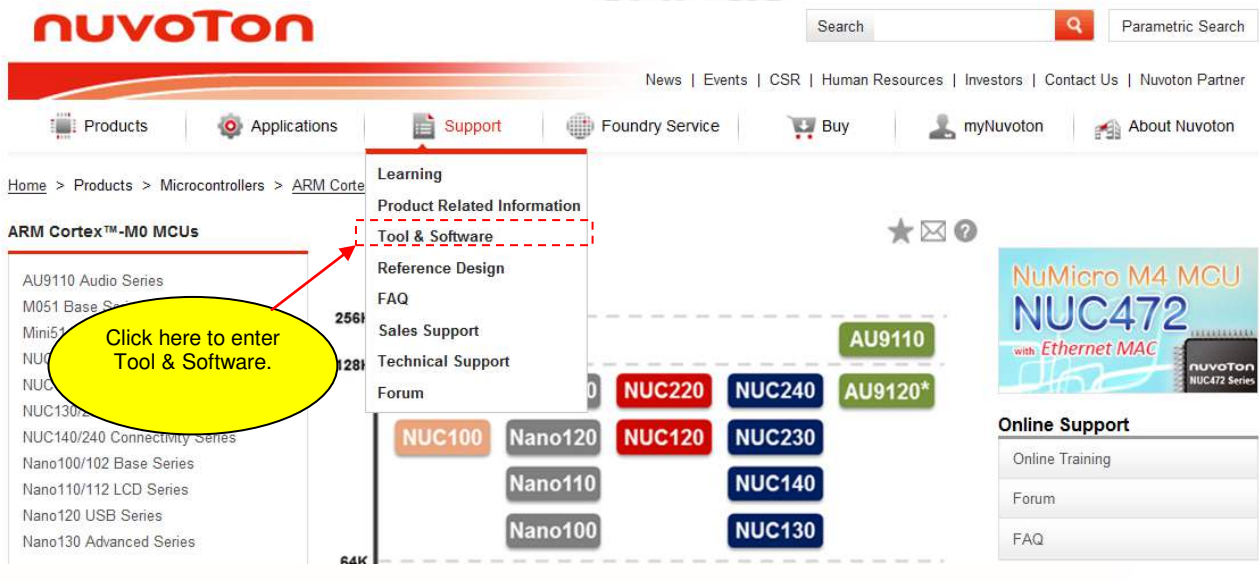
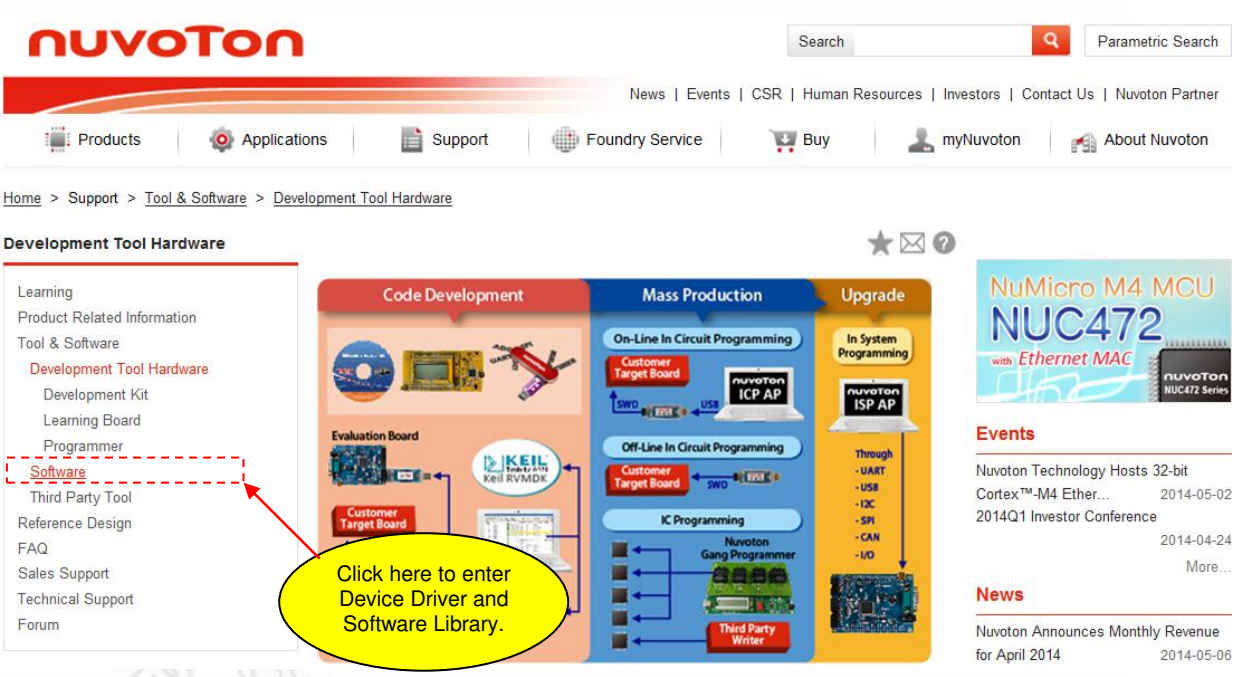

## 6.3 Download NuMicro™ NUC100 Series BSP Software Library

<p><b>Step1</b></p>	<p>Visit the Nuvoton NuMicro™ website: <a href="http://www.nuvoton.com/NuMicro">http://www.nuvoton.com/NuMicro</a>.</p>
<p><b>Step2</b></p>	
<p><b>Step3</b></p>	
<p><b>Step 3</b></p>	<p>Download the NuMicro™ NUC100Series CMSIS BSP.</p>

## 7 Revision History

Revision	Date	Description
1.00	April 20, 2011	Initial release
1.01	Nov 17, 2014	Update Figure 2-1 NuTiny-SDK-NUC140 (Blue PCB Board).

### Important Notice

Nuvoton Products are neither intended nor warranted for usage in systems or equipment, any malfunction or failure of which may cause loss of human life, bodily injury or severe property damage. Such applications are deemed, "Insecure Usage".

Insecure usage includes, but is not limited to: equipment for surgical implementation, atomic energy control instruments, airplane or spaceship instruments, the control or operation of dynamic, brake or safety systems designed for vehicular use, traffic signal instruments, all types of safety devices, and other applications intended to support or sustain life.

All Insecure Usage shall be made at customer's risk, and in the event that third parties lay claims to Nuvoton as a result of customer's Insecure Usage, customer shall indemnify the damages and liabilities thus incurred by Nuvoton.

---

Please note that all data and specifications are subject to change without notice.  
All the trademarks of products and companies mentioned in this datasheet belong to their respective owners.