

一般積層セラミックコンデンサ (高誘電率系・Class 2)

STANDARD MULTILAYER CERAMIC CAPACITORS (CLASS2 :HIGH DIELECTRIC CONSTANT TYPE)

	code	Temp.characteristics	operating Temp. range
OPERATING TEMP.	B/BJ	B	-25~+85°C
		X7R	-55~+125°C
		X5R	-55~+85°C
	F	F	-25~+85°C
		Y5V	-30~+85°C

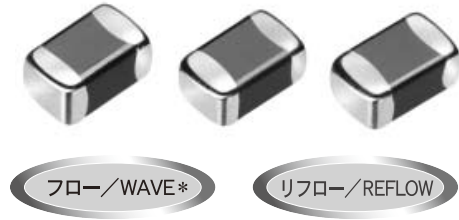

* 042TYPE, 063TYPE, 105TYPEは除く
* Except for 042TYPE, 063TYPE, 105TYPE

特長 FEATURES

- ・実装密度の向上が図れます
- ・モノリシックの構造のため、信頼性が高い
- ・同一形状、静電容量範囲が広い
- ・ Improve Higher Mounting Densities.
- ・ Multilayer block structure provides higher reliability
- ・ A wide range of capacitance values available in standard case sizes.

用途 APPLICATIONS

- ・ 一般電子機器用
- ・ 通信機器用 (携帯電話、PHS、コードレス電話 etc.)
- ・ General electronic equipment
- ・ Communication equipment (cellular phone, PHS, other wireless applications, etc.)

形名表記法 ORDERING CODE

1 定格電圧 (VDC)	4 形状寸法 (EIA) L×W (mm)	6 公称静電容量 (pF)	7 容量許容差 (%)	9 個別仕様
A 4 J 6.3 L 10 E 16 T 25 G 35 U 50	042(01005) 0.4×0.2 063(0201) 0.6×0.3 105(0402) 1.0×0.5 107(0603) 1.6×0.8	例 102 1000 223 22000	K ±10 M ±20 Z $\pm\frac{+80}{-20}$	- 標準
2 シリーズ名	5 温度特性	8 製品厚み (mm)	10 包装	11 当社管理記号
M 積層コンデンサ	△B, BJ ±10% △F $\pm\frac{+80}{-20}$ % △=スペース	C 0.2 P 0.3 V 0.5 Z 0.8	F テーピング (2mmピッチ・178φ) T テーピング (4mmピッチ・178φ)	△ 標準 △=スペース
3 端子電極				
K メッキ品				



1 Rated voltage (VDC)	4 Dimensions (case size) (L×W) (mm)	6 Nominal Capacitance (pF)	7 Capacitance Tolerance (%)	9 Special code
A 4 J 6.3 L 10 E 16 T 25 G 35 U 50	042(01005) 0.4×0.2 063(0201) 0.6×0.3 105(0402) 1.0×0.5 107(0603) 1.6×0.8	example 102 1000 223 22000	K ±10 M ±20 Z $\pm\frac{+80}{-20}$	- Standard products
2 Series name	5 Temperature characteristics code	8 Thickness (mm)	10 Packaging	11 Internal code
M Multilayer ceramic capacitors	△B X7R -55~+125°C ±15% BJ X5R -55~+85°C ±15% △F Y5V -30~+85°C $\pm\frac{+22}{-22}$ % △=Blank space	C 0.2 P 0.3 V 0.5 Z 0.8	F Tape&Reel (2mm pitch・178φ) T Tape&Reel (4mm pitch・178φ)	△ Standard Products △=Blank space
3 End termination				
K Plated				

外形寸法 EXTERNAL DIMENSIONS

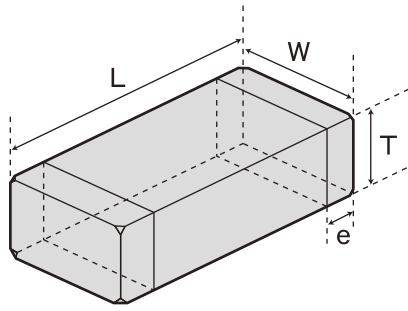

Type (EIA)	L	W	T	e
□MK042 (01005)	0.4±0.02 (0.016±0.001)	0.2±0.02 (0.008±0.001)	0.2±0.02 (0.008±0.001)	C 0.1±0.03 (0.004±0.001)
□MK063 (0201)	0.6±0.03 (0.024±0.001)	0.3±0.03 (0.012±0.001)	0.3±0.03 (0.012±0.001)	P 0.15±0.05 (0.006±0.002)
□MK105 (0402)	1.0±0.05 (0.039±0.002)	0.5±0.05 (0.020±0.002)	0.5±0.05 (0.020±0.002)	V 0.25±0.10 (0.010±0.002)
□MK107 (0603)	1.6±0.10 (0.063±0.004)	0.8±0.10 (0.031±0.004)	0.8±0.10 (0.031±0.004)	Z 0.35±0.25 (0.014±0.010)

Unit : mm (inch)

概略バリエーション AVAILABLE CAPACITANCE RANGE

■汎用積層セラミックコンデンサ (General Multilayer Ceramic capacitors)

Type	042				063								105								107									
	Temp.char.		B/X5R		B/X5R		X5R		F/Y5V		B/X7R		B/X5R		X5R		F/Y5V		B/X7R		F/Y5V									
Cap [pF]	10V	6.3V	25V	16V	10V	6.3V	6.3V	4V	6.3V	4V	50V	25V	16V	35V	25V	16V	10V	6.3V	6.3V	4V	50V	25V	16V	10V	6.3V	50V	25V	50V	25V	
100																														
150																														
220																														
330																														
470																														
680																														
1000																														
1500																														
2200																														
3300																														
4700																														
6800																														
10000																														
15000																														
22000																														
33000																														
47000																														
68000																														
100000																														
220000																														
330000																														
4700000																														

注: グラフの記号は製品厚み記号です。Note : Letter codes in shaded areas are thickness codes.

温度特性コード Temp. char.Code	温度特性 Temperature characteristics					静電容量許容差 [%] Capacitance tolerance	tan δ [%] Dissipation factor
	準拠規格 Applicable standard		温度範囲 [°C] Temperature range	基準温度 [°C] Ref. Temp.	容量変化率 [%] Capacitance change		
	JIS	B	-25~85	20	±10		
BJ	EIA	X7R*	-55~125	25	±15	±20 (M) ±10 (K)	2.5%max.**
	JIS	F	-25~85	20	+30/-80	+80	7.0%max.**
F	EIA	Y5V	-30~85	25	+22/-82	-20 (Z)	

* : X5Rのみ対応するアイテムがあります。詳細はアイテム一覧を参照ください。

** : 代表定期的な値を記載しています。詳細はアイテム一覧を参照ください。

* : Some of parts are only applicable to X5R. Please refer to PART NUMBERS table.

** : The figure indicate typical value. Please refer to PART NUMBERS table.

セレクションガイド
Selection Guide



etc

アイテム一覧
Part Numbers



特性図
Electrical Characteristics



梱包
Packaging



信頼性
Reliability Data



使用上の注意
Precautions



042TYPE (01005 case size)

定格電圧 Rated Voltage (DC)	形名 Ordering code	EHS (Environmental Hazardous Substances)	公称 静電容量 Capacitance [pF]	温度特性 Temp.Char	tan δ Dissipation factor [%] Max.	実装条件 Soldering method R:リフロー Reflow soldering W: フロー Wave soldering	静電容量 許容差 Capacitance tolerance	厚み Thickness mm(inch)
10V	LMK042 BJ101□C	RoHS	100	B/X5R	5	R	±10% ±20%	0.2±0.02 (0.008±0.001)
	LMK042 BJ151□C	RoHS	150					
	LMK042 BJ221□C	RoHS	220					
	LMK042 BJ331□C	RoHS	330					
	LMK042 BJ471□C	RoHS	470					
	LMK042 BJ681□C	RoHS	680					
6.3V	LMK042 BJ102□C	RoHS	1000					
	JMK042 BJ152□C*	RoHS	1500					
	JMK042 BJ222□C*	RoHS	2200					
	JMK042 BJ332□C*	RoHS	3300					
	JMK042 BJ472□C*	RoHS	4700					
	JMK042 BJ682□C*	RoHS	6800					
	JMK042 BJ103□C*	RoHS	10000					

形名の□には静電容量許容差記号が入ります。
* 高温負荷試験の試験電圧は定格電圧の1.5倍

□Please specify the capacitance tolerance code.
* Test voltage of Loading at high temperature test is 1.5 time of the rated voltage.

063TYPE (0201 case size)

定格電圧 Rated Voltage (DC)	形名 Ordering code	EHS (Environmental Hazardous Substances)	公称 静電容量 Capacitance [pF]	温度特性 Temp.Char	tan δ Dissipation factor [%] Max.	実装条件 Soldering method R:リフロー Reflow soldering W: フロー Wave soldering	静電容量 許容差 Capacitance tolerance	厚み Thickness mm(inch)
25V	TMK063 BJ101□P	RoHS	100	B/X5R	3.5	R	±10% ±20%	0.3±0.03 (0.012±0.001)
	TMK063 BJ151□P	RoHS	150					
	TMK063 BJ221□P	RoHS	220					
	TMK063 BJ331□P	RoHS	330					
	TMK063 BJ471□P	RoHS	470					
	TMK063 BJ681□P	RoHS	680					
	TMK063 BJ102□P	RoHS	1000					
16V	EMK063 BJ152□P	RoHS	1500					
	EMK063 BJ222□P	RoHS	2200					
	EMK063 BJ332□P	RoHS	3300					
10V	LMK063 BJ472□P	RoHS	4700					
	LMK063 BJ682□P	RoHS	6800					
	LMK063 BJ103□P	RoHS	10000					
	LMK063 BJ223□P*	RoHS	22000					
6.3V	JMK063 BJ473□P*	RoHS	47000	X5R	7.5	±20%		
	JMK063 BJ104□P*	RoHS	100000					
	JMK063 BJ224MP*	RoHS	220000					
4V	AMK063 BJ224MP*	RoHS	220000					
	AMK063 BJ334MP*	RoHS	330000					
	AMK063 BJ474MP*	RoHS	470000					
6.3V	JMK063 F223ZP	RoHS	22000		F/Y5V		12.5	+80% -20%
	JMK063 F473ZP	RoHS	47000					
4V	AMK063 F104ZP	RoHS	100000					

形名の□には静電容量許容差記号が入ります。
* 高温負荷試験の試験電圧は定格電圧の1.5倍

□Please specify the capacitance tolerance code.
* Test voltage of Loading at high temperature test is 1.5 time of the rated voltage.

105TYPE (0402 case size)

定格電圧 Rated Voltage (DC)	形名 Ordering code	EHS (Environmental Hazardous Substances)	公称 静電容量 Capacitance [pF]	温度特性 Temp.Char	tan δ Dissipation factor [%] Max.	実装条件 Soldering method R:リフロー- Reflow soldering W: 70- Wave soldering	静電容量 許容差 Capacitance tolerance	厚み Thickness [mm] (inch)
50V	UMK105 BJ221□V	RoHS	220	B/X7R	2.5	R	±10% ±20%	0.5±0.05
	UMK105 BJ331□V	RoHS	330					
	UMK105 BJ471□V	RoHS	470					
	UMK105 BJ681□V	RoHS	680					
	UMK105 BJ102□V	RoHS	1000					
	UMK105 BJ152□V	RoHS	1500					
	UMK105 BJ222□V	RoHS	2200					
35V	UMK105 BJ332□V	RoHS	3300	B/X5R	5	R	0.5±0.05	
25V	TMK105 BJ472□V	RoHS	4700	B/X7R	2.5			
	TMK105 BJ682□V	RoHS	6800		3.5			
	TMK105 BJ103□V	RoHS	10000	B/X5R	5			
	TMK105 BJ104□V*	RoHS	100000					
16V	EMK105 BJ153□V	RoHS	15000	B/X7R	3.5			
	EMK105 BJ223□V	RoHS	22000					
	EMK105 BJ333□V	RoHS	33000					
	EMK105 BJ473□V	RoHS	47000					
	EMK105 BJ104□V*	RoHS	100000※					
	EMK105 BJ104□V*	RoHS	100000					
10V	EMK105 BJ224□V*	RoHS	220000	B/X5R	5			
	LМК105 BJ104□V	RoHS	100000					
	LМК105 BJ224□V*	RoHS	220000					
	LМК105 BJ474□V*	RoHS	470000					
6.3V	LМК105 BJ105□V*	RoHS	1000000	B/X5R	10			
	JMK105 BJ224□V*	RoHS	220000					
	JMK105 BJ474□V*	RoHS	470000					
	JMK105 BJ105□V*	RoHS	1000000					
4V	JMK105 BJ225MV*	RoHS	220000	X5R	10	±20%		
	AMK105 BJ335MV*	RoHS	330000					
50V	AMK105 BJ475MV*	RoHS	470000	F/Y5V	5	+80% -20%		
25V	UMK105 F103ZV	RoHS	10000					
	TMK105 F223ZV	RoHS	22000					
16V	EMK105 F473ZV	RoHS	47000					
	EMK105 F104ZV	RoHS	100000					
10V	LМК105 F224ZV	RoHS	220000					
	JMK105 F474ZV	RoHS	470000					
6.3V	JMK105 F105ZV*	RoHS	1000000					
	JMK105 F105ZV*	RoHS	1000000					

形名の□には静電容量許容差記号が入ります。
* 高温負荷試験の試験電圧は定格電圧の1.5倍
※品名末尾にRが付きます。

□ Please specify the capacitance tolerance code.
* Test voltage of Loading at high temperature test is 1.5 time of the rated voltage.
※ Internal Code shall be R.

107TYPE (0603 case size)

定格電圧 Rated Voltage (DC)	形名 Ordering code	EHS (Environmental Hazardous Substances)	公称 静電容量 Capacitance [pF]	温度特性 Temp.Char	tan δ Dissipation factor [%] Max.	実装条件 Soldering method R:リフロー- Reflow soldering W: 70- Wave soldering	静電容量 許容差 Capacitance tolerance	厚み Thickness [mm] (inch)
50V	UMK107 B102□Z	RoHS	1000	B/X7R	2.5	W, R	±10% ±20%	0.8±0.10 (0.031±0.004)
	UMK107 B152□Z	RoHS	1500					
	UMK107 B222□Z	RoHS	2200					
	UMK107 B332□Z	RoHS	3300					
	UMK107 B472□Z	RoHS	4700					
	UMK107 B682□Z	RoHS	6800					
	UMK107 B103□Z	RoHS	10000					
25V	TMK107 B153□Z	RoHS	15000	F/Y5V	5	+80% -20%		
	TMK107 B223□Z	RoHS	22000					
50V	UMK107 F103ZZ	RoHS	10000	F/Y5V	5	+80% -20%		
	UMK107 F223ZZ	RoHS	22000					
25V	TMK107 F473ZZ	RoHS	47000	F/Y5V	5	+80% -20%		
	TMK107 F104ZZ	RoHS	100000					

形名の□には静電容量許容差記号が入ります。

□ Please specify the capacitance tolerance code.

梱包 PACKAGING

①最小受注単位数 Minimum Quantity

■テーピング梱包 Taped packaging

形式 (EIA) Type	製品厚み Thickness		標準数量 Standard quantity [pcs]	
	mm (inch)	code	紙テープ paper	エンボステープ Embossed tape
□MK042 (01005)	0.2 (0.008)	C	15000	—
□MK063 (0201)	0.3 (0.012)	P	15000	—
□2K096 (0302)	0.3 (0.012)	P	10000	—
	0.45 (0.018)	K		
□MK105 (0402)	0.5 (0.020)	V, W	10000	—
		W		
□MK107 (0603)	0.45 (0.018)	K	4000	—
		V		
□WK107 (0306)	0.5 (0.020)	V	—	4000
		A	4000	—
□2K110 (0504)	0.8 (0.031)	Z	4000	—
		A	4000	—
□MK212 (0805)	0.6 (0.024)	B	4000	—
		K	4000	—
□WK212 (0508)	0.45 (0.018)	K	4000	—
		D	4000	—
□4K212 (0805)	0.85 (0.033)	D	4000	—
		G	—	3000
□2K212 (0805)	1.25 (0.049)	G	—	3000
		D	4000	—
□MK316 (1206)	0.85 (0.033)	D	—	3000
		G	—	3000
□WK316 (0612)	1.15 (0.045)	F	—	3000
		L	—	2000
		D	—	2000
		F	—	2000
□MK325 (1210)	1.5 (0.059)	H	—	2000
		N	—	2000
		Y	—	2000
		M	—	500,1000
□MK432 (1812)	1.9 (0.075)	Y	—	1000
		M	—	500
	2.5 (0.098)	M	—	500
		U	—	500
	3.2 (0.125)	U	—	500

②テーピング材質 Taping material

紙テープ
Card board carrier tape

※プレスポケットタイプは、
ボトムテープ無し。

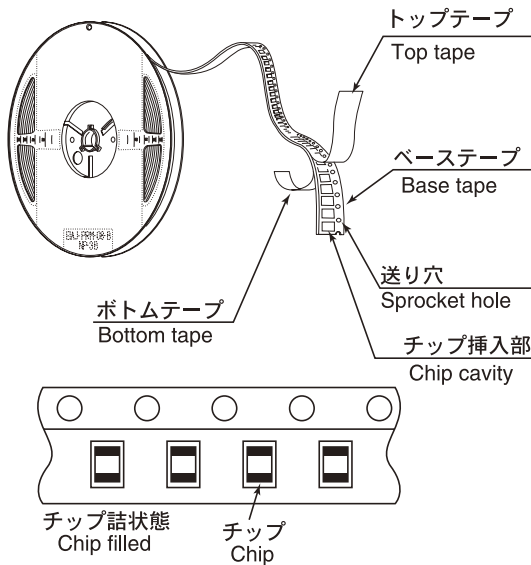

エンボステープ
Embossed Tape

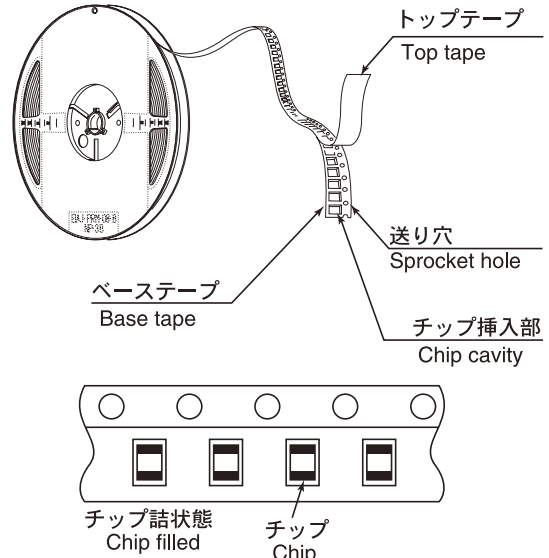

③バルクカセット Bulk Cassette

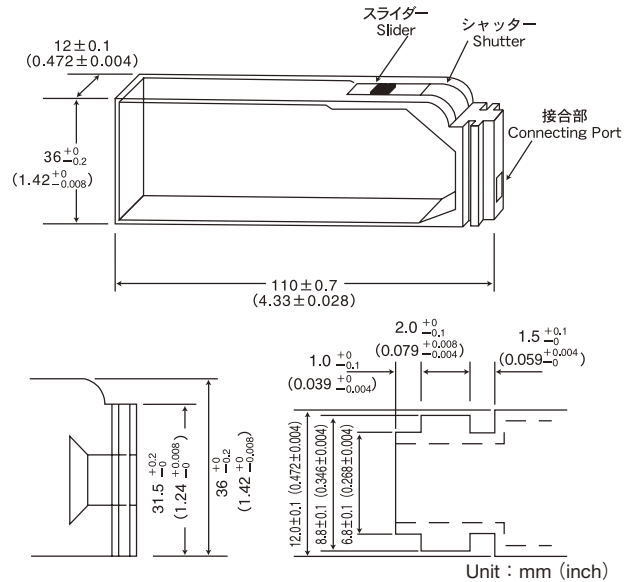

105, 107, 212形状で個別対応致しますのでお問い合わせ下さい。
Please contact any of our offices for accepting your requirement according to dimensions 0402, 0603, 0805.(inch)

梱包 PACKAGING

③テーピング寸法 Taping dimensions
紙テープ Paper Tape (8mm幅) (0.315inches wide)

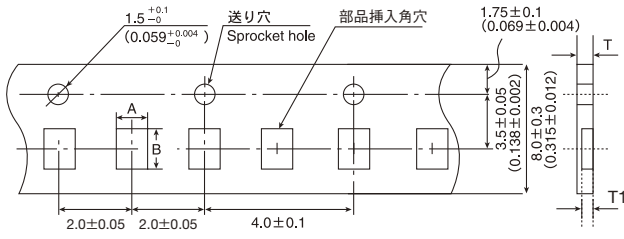

Type (EIA)	チップ挿入部 Chip Cavity		挿入ピッチ Insertion Pitch	テープ厚み Tape Thickness	
	A	B		T	T ₁
□MK042 (01005)	0.25 (0.010)	0.45 (0.018)	2.0±0.05 (0.079±0.002)	0.36max (0.014)	0.27max (0.011)
□MK063 (0201)	0.37 (0.016)	0.67 (0.027)	2.0±0.05 (0.079±0.002)	0.45max (0.018)	0.42max (0.017)

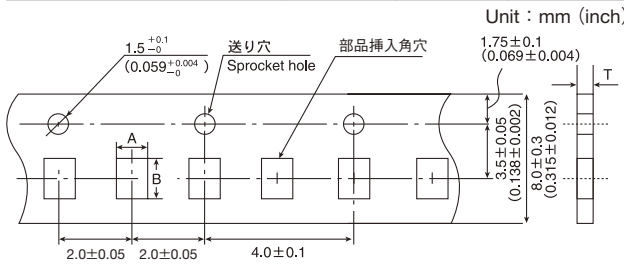

Type (EIA)	チップ挿入部 Chip Cavity		挿入ピッチ Insertion Pitch	テープ厚み Tape Thickness	
	A	B		T	
□2K096 (0302)	0.72 (0.028)	1.02 (0.040)	2.0±0.05 (0.079±0.002)	0.45max, (0.018max)	0.6max, (0.024max)
□MK105 (0402)	0.65 (0.026)	1.15 (0.045)	2.0±0.05 (0.079±0.002)	0.8max.	0.31max.

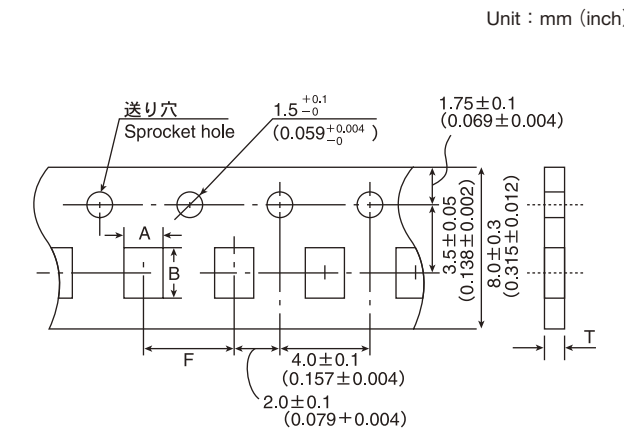

Type (EIA)	チップ挿入部 Chip Cavity		挿入ピッチ Insertion Pitch	テープ厚み Tape Thickness	
	A	B		T	
□MK107 (0603)	1.0 (0.039)	1.8 (0.071)	4.0±0.1 (0.157±0.004)	1.1max.	(0.043max.)
□WK107 (0306)					
□2K110 (0504)	1.15 (0.045)	1.55 (0.061)	4.0±0.1 (0.157±0.004)	1.0max.	(0.039max.)
□MK212 (0805)	1.65 (0.065)	2.4 (0.094)	4.0±0.1 (0.157±0.004)	1.1max.	(0.043max.)
□WK212 (0508)					
□4K212 (0805)					
□2K212 (0805)					
□MK316 (1206)	2.0 (0.079)	3.6 (0.142)			
□WK316 (0612)					

Unit : mm (inch)

エンボステープ Embossed tape (8mm幅) (0.315inches wide)

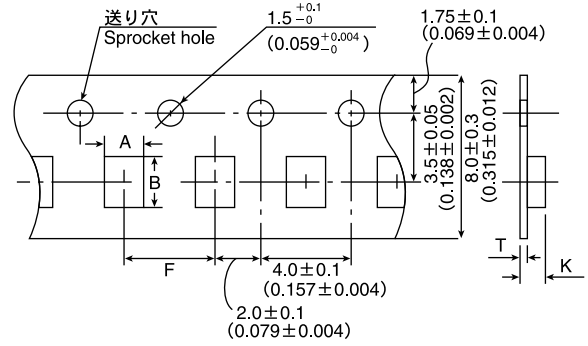

Type (EIA)	チップ挿入部 Chip cavity		挿入ピッチ Insertion Pitch	テープ厚み Tape Thickness	
	A	B		K	T
□WK107 (0306)	1.0 (0.039)	1.8 (0.071)	4.0±0.1 (0.157±0.004)	1.3max. (0.051max.)	0.25±0.1 (0.01±0.004)
□MK212 (0805)	1.65 (0.065)	2.4 (0.094)		2.5max. (0.098max.)	0.6max (0.024max.)
□MK316 (1206)	2.0 (0.079)	3.6 (0.142)		3.4max. (0.134max.)	
□MK325 (1210)	2.8 (0.110)	3.6 (0.142)			

Unit : mm (inch)

エンボステープ Embossed tape (12mm幅) (0.472inches wide)

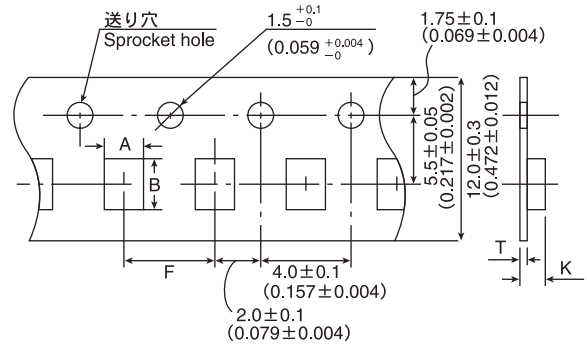

Type (EIA)	チップ挿入部 Chip cavity		挿入ピッチ Insertion Pitch	テープ厚み Tape Thickness	
	A	B		K	T
□MK432 (1812)	3.7 (0.146)	4.9 (0.193)	8.0±0.1 (0.315±0.004)	4.0max. (0.157max.)	0.6max. (0.024max.)

Unit : mm (inch)

④リーダー部／空部 Leader and Blank portion

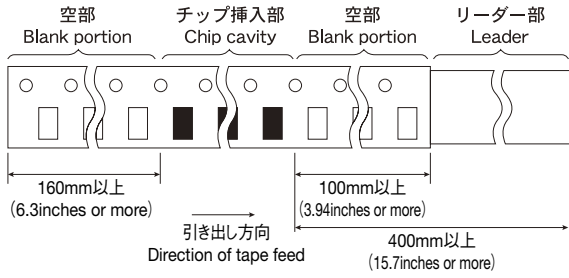

⑤リール寸法 Reel size

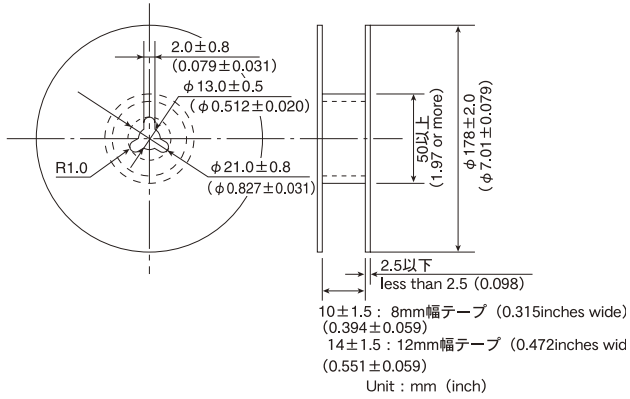

⑥トップテープ強度 Top Tape Strength

トップテープのはがし力は下図矢印方向にて0.1~0.7Nとなります。
The top tape requires a peel-off force of 0.1~0.7N in the direction of the arrow as illustrated below.

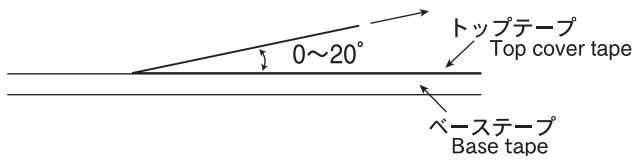

Multilayer Ceramic Capacitor Chips

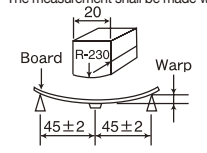
Item	Specified Value				Test Methods and Remarks
	Temperature Compensating (Class 1)		High Permittivity (Class 2)		
	Standard	High Frequency Type	Standard Note1	High Value	
1. Operating Temperature Range	-55 to +125°C		BJ : -55 to +125°C F : -25 to +85°C	-25 to +85°C	High Capacitance Type BJ (X7R) : -55~+125°C, BJ (X5R) : -55~+85°C E (Y5U) : -30~+85°C, F (Y5V) : -30~+85°C
2. Storage Temperature Range	-55 to +125°C		BJ : -55 to +125°C F : -25 to +85°C	-25 to +85°C	High Capacitance Type BJ (X7R) : -55~+125°C, BJ (X5R) : -55~+85°C E (Y5U) : -30~+85°C, F (Y5V) : -30~+85°C
3. Rated Voltage	50VDC, 25VDC, 16VDC	16VDC 50VDC	50VDC, 25VDC	50VDC, 35VDC, 25VDC 16VDC, 10VDC, 6.3VDC 4VDC, 2.5VDC	
4. Withstanding Voltage Between terminals	No breakdown or damage	No abnormality	No breakdown or damage		Applied voltage: Rated voltage × 3 (Class 1) Rated voltage × 2.5 (Class 2) Duration: 1 to 5 sec. Charge/discharge current: 50mA max. (Class 1,2)
5. Insulation Resistance	10000 MΩ min.		500 MΩ μF, or 10000 MΩ., whichever is the smaller. Note 5		Applied voltage: Rated voltage Duration: 60 ± 5 sec. Charge/discharge current: 50mA max.
6. Capacitance (Tolerance)	0.5 to 5 pF : ±0.25 pF 1 to 10 pF : ±0.5 pF 5 to 10 pF : ±1 pF 11 pF or over : ± 5% ± 10% 105TYPE [△] , S [△] , T [△] , U [△] only 0.5~2pF : ±0.1pF 2.2~20pF : ±5%	0.5 to 2 pF : ±0.1 pF 2.2 to 5.1 pF : ±5%	BJ : ±10%, ±20% F : +80% -20%	BJ : ±10%, ±20% F : -20% / +80%	Measuring frequency : Class 1 : 1MHz ± 10% (C ≤ 1000pF) 1 k Hz ± 10% (C > 1000pF) Class 2 : 1 k Hz ± 10% (C ≤ 10 μF) 120Hz ± 10Hz (C > 10 μF) Measuring voltage : Note 4 Class 1 : 0.5~5Vrms (C ≤ 1000pF) 1 ± 0.2Vrms (C > 1000pF) Class 2 : 1 ± 0.2Vrms (C ≤ 10 μF) 0.5 ± 0.1Vrms (C > 10 μF) Bias application: None
7. Q or Tangent of Loss Angle (tan δ)	Under 30 pF : Q ≥ 400 + 20C 30 pF or over : Q ≥ 1000 C = Nominal capacitance	Refer to detailed specification	BJ : 2.5% max. (50V, 25V) F : 5.0% max. (50V, 25V) Note 4	BJ : 2.5% max. F : 7% max. Note 4	Multilayer: Measuring frequency : Class 1 : 1MHz ± 10% (C ≤ 1000pF) 1 k Hz ± 10% (C > 1000pF) Class 2 : 1 k Hz ± 10% (C ≤ 10 μF) 120Hz ± 10Hz (C > 10 μF) Measuring voltage : Note 4 Class 1 : 0.5~5Vrms (C ≤ 1000pF) 1 ± 0.2Vrms (C > 1000pF) Class 2 : 1 ± 0.2Vrms (C ≤ 10 μF) 0.5 ± 0.1Vrms (C > 10 μF) Bias application: None High-Frequency-Multilayer: Measuring frequency: 1GHz Measuring equipment: HP4291A Measuring jig: HP16192A
8. Temperature Characteristic of Capacitance	(Without voltage application) CK : 0 ± 250 CJ : 0 ± 120 CH : 0 ± 60 CG : 0 ± 30 RH : -220 ± 60 SK : -330 ± 250 SJ : -330 ± 120 SH : -330 ± 60 TK : -470 ± 250 TJ : -470 ± 120 UK : -750 ± 250 UJ : -750 ± 120 SL : +350 to -1000 (ppm/°C)	CH : 0 ± 60 RH : -220 ± 60 (ppm/°C)	BJ : ±10% (-25~85°C) F : +30% (-25~85°C) -80 BJ (X7R) : ±15% F (Y5V) : +22% -82	BJ : ±10% (-25~+85°C) F : +30% / -80% (-25~+85°C) BJ (X7R, X5R) : ±15% F (Y5V) : +22% / -82%	According to JIS C 5102 clause 7.12. Temperature compensating: Measurement of capacitance at 20°C and 85°C shall be made to calculate temperature characteristic by the following equation. $\frac{C_{85} - C_{20}}{C_{20} \times \Delta T} \times 10^6 \text{ (ppm/°C)}$ High permittivity: Change of maximum capacitance deviation in step 1 to 5 Temperature at step 1: +20°C Temperature at step 2: minimum operating temperature Temperature at step 3: +20°C (Reference temperature) Temperature at step 4: maximum operating temperature Temperature at step 5: +20°C Reference temperature for X7R, X5R, Y5U and Y5V shall be +25°C
9. Resistance to Flexure of Substrate	Appearance: No abnormality Capacitance change: Within ±5% or ±0.5 pF, whichever is larger.	Appearance: No abnormality Capacitance change: Within ±0.5 pF	Appearance: No abnormality Capacitance change: BJ : Within ±12.5% F : Within ±30%		Warp: 1mm Testing board: glass epoxy-resin substrate Thickness: 1.6mm (063 TYPE : 0.8mm) The measurement shall be made with board in the bent position.  (Unit: mm)

Multilayer Ceramic Capacitor Chips

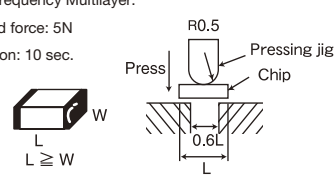
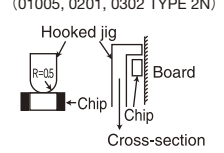
Item	Specified Value				Test Methods and Remarks
	Temperature Compensating (Class 1)		High Permittivity (Class 2)		
	Standard	High Frequency Type	Standard Note1	High Value	
10.Body Strength	—	No mechanical damage.	—	—	High Frequency Multilayer: Applied force: 5N Duration: 10 sec. 
11.Adhesion of Electrode	No separation or indication of separation of electrode.			Applied force: 5N Duration: 30±5 sec. 	
12.Solderability	At least 95% of terminal electrode is covered by new solder.			Solder temperature: 230±5°C Duration: 4±1 sec.	
13.Resistance to soldering	Appearance: No abnormality Capacitance change: Within ±2.5% or ±0.25pF, whichever is larger. Q: Initial value Insulation resistance: Initial value Withstanding voltage (between terminals): No abnormality	Appearance: No abnormality Capacitance change: Within ±2.5% Q: Initial value Insulation resistance: Initial value Withstanding voltage (between terminals): No abnormality	Appearance: No abnormality Capacitance change: Within ±7.5% (BJ) Within ±20% (F) tan δ: Initial value Note 4 Insulation resistance: Initial value Withstanding voltage (between terminals): No abnormality	Preconditioning: Thermal treatment (at 150°C for 1 hr) (Applicable to Class 2.) Solder temperature: 270±5°C Duration: 3±0.5 sec. Preheating conditions: 80 to 100°C, 2 to 5 min. or 5 to 10 min. 150 to 200°C, 2 to 5 min. or 5 to 10 min. Recovery: Recovery for the following period under the standard condition after the test. 6~24 hrs (Class 1) 24±2 hrs (Class 2)	
14.Thermal shock	Appearance: No abnormality Capacitance change: Within ±2.5% or ±0.25pF, whichever is larger. Q: Initial value Insulation resistance: Initial value Withstanding voltage (between terminals): No abnormality	Appearance: No abnormality Capacitance change: Within ±0.25pF Q: Initial value Insulation resistance: Initial value Withstanding voltage (between terminals): No abnormality	Appearance: No abnormality Capacitance change: Within ±7.5% (BJ) Within ±20% (F) tan δ: Initial value Note 4 Insulation resistance: Initial value Withstanding voltage (between terminals): No abnormality	Preconditioning: Thermal treatment (at 150°C for 1 hr) (Applicable to Class 2.) Conditions for 1 cycle: Step 1: Minimum operating temperature $+0_{-3}^{\circ}\text{C}$ 30±3 min. Step 2: Room temperature 2 to 3 min. Step 3: Maximum operating temperature $+0_{-3}^{\circ}\text{C}$ 30±3 min. Step 4: Room temperature 2 to 3 min. Number of cycles: 5 times Recovery after the test: 6~24 hrs (Class 1) 24±2 hrs (Class 2)	
15.Damp Heat (steady state)	Appearance: No abnormality Capacitance change: Within ±5% or ±0.5pF, whichever is larger. Q: $C \geq 30 \text{ pF} : Q \geq 350$ $10 \leq C < 30 \text{ pF} : Q \geq 275 + 2.5C$ $C < 10 \text{ pF} : Q \geq 200 + 10C$ C: Nominal capacitance Insulation resistance: 1000 MΩ min.	Appearance: No abnormality Capacitance change: Within ±0.5pF, Insulation resistance: 1000 MΩ min.	Appearance: No abnormality Capacitance change: BJ: Within ±12.5% F: Within ±30% tan δ: BJ: 5.0% max. F: 7.5% max. Note 4 Insulation resistance: 50 MΩ μF or 1000 MΩ whichever is smaller. Note 5	Appearance: No abnormality Capacitance change: BJ: Within ±12.5% Note 4 tan δ: BJ: 5.0% max. Note 4. F: 11.0% max. Insulation resistance: 50 MΩ μF or 1000 MΩ whichever is smaller. Note 5	Multilayer : Preconditioning: Thermal treatment (at 150°C for 1 hr) (Applicable to Class 2.) Temperature: 40±2°C Humidity: 90 to 95% RH Duration: 500 $+24_{-0}$ hrs Recovery: Recovery for the following period under the standard condition after the removal from test chamber. 6~24 hrs (Class 1) 24±2 hrs (Class 2) High-Frequency Multilayer: Temperature: 60±2°C Humidity: 90 to 95% RH Duration: 500 $+24_{-0}$ hrs Recovery: Recovery for the following period under the standard condition after the removal from test chamber. 6~24 hrs (Class 1)

Multilayer Ceramic Capacitor Chips

Item	Specified Value				Test Methods and Remarks
	Temperature Compensating (Class 1)		High Permittivity (Class 2)		
	Standard	High Frequency Type	Standard Note1	High Value	
16>Loading under Damp Heat	Appearance: No abnormality Capacitance change: Within $\pm 7.5\%$ or $\pm 0.75\text{pF}$, whichever is larger. Q: $C \geq 30\text{pF}$: $Q \geq 200$ $C < 30\text{pF}$: $Q \geq 100 + 10C/3$ C : Nominal capacitance Insulation resistance: 500 M Ω min.	Appearance: No abnormality Capacitance change: $C \leq 2\text{pF}$: Within $\pm 0.4\text{pF}$ $C > 2\text{pF}$: Within $\pm 0.75\text{pF}$ C : Nominal capacitance Insulation resistance: 500 M Ω min.	Appearance: No abnormality Capacitance change: BJ: Within $\pm 12.5\%$ F: Within $\pm 30\%$ Note 4 tan δ : BJ: 5.0% max. F: 7.5% max. Note 4 Insulation resistance: 25 M $\Omega \mu\text{F}$ or 500 M Ω , whichever is the smaller. Note 5	Appearance: No abnormality Capacitance change: BJ: Within $\pm 12.5\%$ F: Within $\pm 30\%$ Note 4 tan δ : BJ: 5.0% max. F: 11% max. Note 4 Insulation resistance: 25 M $\Omega \mu\text{F}$ or 500 M Ω , whichever is the smaller. Note 5	According to JIS C 5102 Clause 9. 9. Multilayer: Preconditioning: Voltage treatment (Class 2) Temperature: $40 \pm 2^\circ\text{C}$ Humidity: 90 to 95% RH Duration: 500_{-0}^{+24} hrs Applied voltage: Rated voltage Charge and discharge current: 50mA max. (Class 1,2) Recovery: Recovery for the following period under the standard condition after the removal from test chamber. 6~24 hrs (Class 1) 24 ± 2 hrs (Class 2) High-Frequency Multilayer: Temperature: $60 \pm 2^\circ\text{C}$ Humidity: 90 to 95% RH Duration: 500_{-0}^{+24} hrs Applied voltage: Rated voltage Charge and discharge current: 50mA max. Recovery: 6~24 hrs of recovery under the standard condition after the removal from test chamber.
17>Loading at High Temperature	Appearance: No abnormality Capacitance change: Within $\pm 3\%$ or $\pm 0.3\text{pF}$, whichever is larger. Q: $C \geq 30\text{pF}$: $Q \geq 350$ $10 \leq C < 30\text{pF}$: $Q \geq 275 + 2.5C$ $C < 10\text{pF}$: $Q \geq 200 + 10C$ C : Nominal capacitance Insulation resistance: 1000 M Ω min.	Appearance: No abnormality Capacitance change: Within $\pm 3\%$ or $\pm 0.3\text{pF}$, whichever is larger. Insulation resistance: 1000 M Ω min.	Appearance: No abnormality Capacitance change: BJ: Within $\pm 12.5\%$ F: Within $\pm 30\%$ Note 4 tan δ : BJ: 4.0% max. F: 7.5% max. Note 4 Insulation resistance: 50 M $\Omega \mu\text{F}$ or 1000 M Ω , whichever is smaller. Note 5	Appearance: No abnormality Capacitance change: BJ: Within $\pm 12.5\%$ Within $\pm 20\% \ast \ast$ Within $\pm 25\% \ast \ast$ F: Within $\pm 30\%$ Note 4 tan δ : BJ: 5.0% max. F: 11% max. Note 4 Insulation resistance: 50 M $\Omega \mu\text{F}$ or 1000 M Ω , whichever is smaller. Note 5	According to JIS C 5102 clause 9.10. Multilayer: Preconditioning: Voltage treatment (Class 2) Temperature: $125 \pm 3^\circ\text{C}$ (Class 1, Class 2: B, BJ (X7R)) $85 \pm 2^\circ\text{C}$ (Class 2: BJ,F) Duration: 1000_{-0}^{+48} hrs Applied voltage: Rated voltage $\times 2$ Note 6 Recovery: Recovery for the following period under the standard condition after the removal from test chamber. As for Ni product, thermal treatment shall be performed prior to the recovery. 6~24 hrs (Class 1) 24 ± 2 hrs (Class 2) High-Frequency Multilayer: Temperature: $125 \pm 3^\circ\text{C}$ (Class 1) Duration: 1000_{-0}^{+48} hrs Applied voltage: Rated voltage $\times 2$ Recovery: 6~24 hrs of recovery under the standard condition after the removal from test chamber.

Note 1 :For 105 type, specified in "High value".

Note 2 :Thermal treatment (Multilayer): 1 hr of thermal treatment at $150 \pm 0 / -10^\circ\text{C}$ followed by 24 ± 2 hrs of recovery under the standard condition shall be performed before the measurement.

Note 3 :Voltage treatment (Multilayer): 1 hr of voltage treatment under the specified temperature and voltage for testing followed by 24 ± 2 hrs of recovery under the standard condition shall be performed before the measurement.

Note 4, 5 :The figure indicates typical inspection. Please refer to individual specifications.

Note 6 :Some of the parts are applicable in rated voltage $\times 1.5$. Please refer to individual specifications.





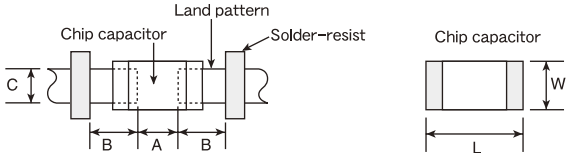
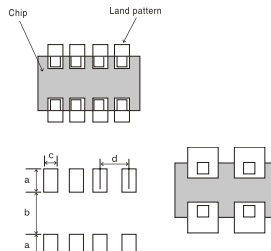
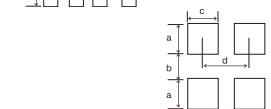

Note on standard condition: "standard condition" referred to herein is defined as follows: 5 to 35°C of temperature, 45 to 85% relative humidity, and 86 to 106kPa of air pressure.

When there are questions concerning measurement results: In order to provide correlation data, the test shall be conducted under condition of $20 \pm 2^\circ\text{C}$ of temperature, 60 to 70% relative humidity, and 86 to 106kPa of air pressure. Unless otherwise specified, all the tests are conducted under the "standard condition."

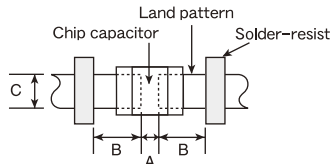
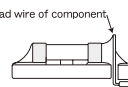
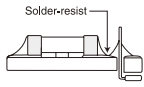
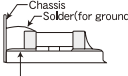
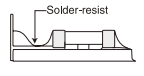
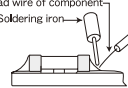
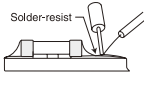
Precautions on the use of Multilayer Ceramic Capacitors

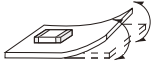
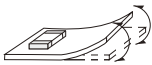
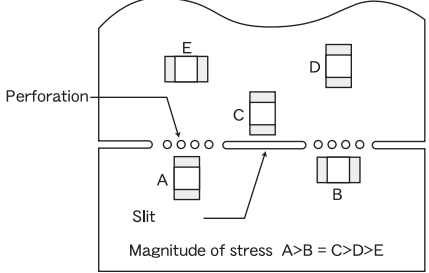
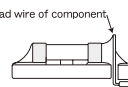
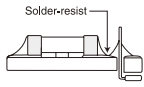
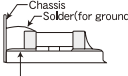
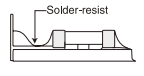
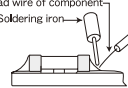
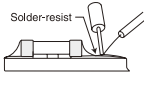
Stages	Precautions	Technical considerations																																																																																																																																		
1.Circuit Design	<p>Verification of operating environment, electrical rating and performance</p> <p>1. A malfunction in medical equipment, spacecraft, nuclear reactors, etc. may cause serious harm to human life or have severe social ramifications. As such, any capacitors to be used in such equipment may require higher safety and/or reliability considerations and should be clearly differentiated from components used in general purpose applications.</p> <p>Operating Voltage (Verification of Rated voltage)</p> <p>1. The operating voltage for capacitors must always be lower than their rated values.</p> <p>If an AC voltage is loaded on a DC voltage, the sum of the two peak voltages should be lower than the rated value of the capacitor chosen. For a circuit where both an AC and a pulse voltage may be present, the sum of their peak voltages should also be lower than the capacitor's rated voltage.</p> <p>2. Even if the applied voltage is lower than the rated value, the reliability of capacitors might be reduced if either a high frequency AC voltage or a pulse voltage having rapid rise time is present in the circuit.</p>																																																																																																																																			
2.PCB Design	<p>Pattern configurations (Design of Land-patterns)</p> <p>1. When capacitors are mounted on a PCB, the amount of solder used (size of fillet) can directly affect capacitor performance. Therefore, the following items must be carefully considered in the design of solder land patterns:</p> <p>(1) The amount of solder applied can affect the ability of chips to withstand mechanical stresses which may lead to breaking or cracking. Therefore, when designing land-patterns it is necessary to consider the appropriate size and configuration of the solder pads which in turn determines the amount of solder necessary to form the fillets.</p> <p>(2) When more than one part is jointly soldered onto the same land or pad, the pad must be designed so that each component's soldering point is separated by solder-resist.</p>	<p>1.The following diagrams and tables show some examples of recommended patterns to prevent excessive solder amounts. (larger fillets which extend above the component end terminations)</p> <p>Examples of improper pattern designs are also shown.</p> <p>(1) Recommended land dimensions for a typical chip capacitor land patterns for PCBs</p>  <p>Recommended land dimensions for wave-soldering (unit: mm)</p> <table border="1" data-bbox="849 1255 1228 1430"> <thead> <tr> <th>Type</th> <th>107</th> <th>212</th> <th>316</th> <th>325</th> </tr> </thead> <tbody> <tr> <td rowspan="2">Size</td> <td>L</td> <td>1.6</td> <td>2.0</td> <td>3.2</td> <td>3.2</td> </tr> <tr> <td>W</td> <td>0.8</td> <td>1.25</td> <td>1.6</td> <td>2.5</td> </tr> <tr> <td>A</td> <td>0.8~1.0</td> <td>1.0~1.4</td> <td>1.8~2.5</td> <td>1.8~2.5</td> </tr> <tr> <td>B</td> <td>0.5~0.8</td> <td>0.8~1.5</td> <td>0.8~1.7</td> <td>0.8~1.7</td> </tr> <tr> <td>C</td> <td>0.6~0.8</td> <td>0.9~1.2</td> <td>1.2~1.6</td> <td>1.8~2.5</td> </tr> </tbody> </table> <p>Recommended land dimensions for reflow-soldering (unit: mm)</p> <table border="1" data-bbox="849 1496 1452 1681"> <thead> <tr> <th>Type</th> <th>042</th> <th>063</th> <th>105</th> <th>107</th> <th>212</th> <th>316</th> <th>325</th> <th>432</th> </tr> </thead> <tbody> <tr> <td rowspan="2">Size</td> <td>L</td> <td>0.4</td> <td>0.6</td> <td>1.0</td> <td>1.6</td> <td>2.0</td> <td>3.2</td> <td>3.2</td> <td>4.5</td> </tr> <tr> <td>W</td> <td>0.2</td> <td>0.3</td> <td>0.5</td> <td>0.8</td> <td>1.25</td> <td>1.6</td> <td>2.5</td> <td>3.2</td> </tr> <tr> <td>A</td> <td>0.15~0.25</td> <td>0.20~0.30</td> <td>0.45~0.55</td> <td>0.6~0.8</td> <td>0.8~1.2</td> <td>1.8~2.5</td> <td>1.8~2.5</td> <td>2.5~3.5</td> </tr> <tr> <td>B</td> <td>0.10~0.20</td> <td>0.20~0.30</td> <td>0.40~0.50</td> <td>0.6~0.8</td> <td>0.8~1.2</td> <td>1.0~1.5</td> <td>1.0~1.5</td> <td>1.5~1.8</td> </tr> <tr> <td>C</td> <td>0.15~0.30</td> <td>0.25~0.40</td> <td>0.45~0.55</td> <td>0.6~0.8</td> <td>0.9~1.6</td> <td>1.2~2.0</td> <td>1.8~3.2</td> <td>2.3~3.5</td> </tr> </tbody> </table> <p>Excess solder can affect the ability of chips to withstand mechanical stresses. Therefore, please take proper precautions when designing land-patterns.</p> <table border="1" data-bbox="849 1747 997 1921"> <thead> <tr> <th>Type</th> <th>212 (4 circuits)</th> </tr> </thead> <tbody> <tr> <td rowspan="2">Size</td> <td>L</td> <td>2.0</td> </tr> <tr> <td>W</td> <td>1.25</td> </tr> <tr> <td>a</td> <td>0.5~0.6</td> </tr> <tr> <td>b</td> <td>0.5~0.6</td> </tr> <tr> <td>c</td> <td>0.2~0.3</td> </tr> <tr> <td>d</td> <td>0.5</td> </tr> </tbody> </table>  <table border="1" data-bbox="849 1932 1181 2107"> <thead> <tr> <th>Type</th> <th>212 (2 circuits)</th> <th>110 (2 circuits)</th> <th>096 (2 circuits)</th> </tr> </thead> <tbody> <tr> <td rowspan="2">Size</td> <td>L</td> <td>2.0</td> <td>1.37</td> <td>0.9</td> </tr> <tr> <td>W</td> <td>1.25</td> <td>1.0</td> <td>0.6</td> </tr> <tr> <td>a</td> <td>0.5~0.6</td> <td>0.35~0.45</td> <td>0.25~0.35</td> </tr> <tr> <td>b</td> <td>0.5~0.6</td> <td>0.55~0.65</td> <td>0.15~0.25</td> </tr> <tr> <td>c</td> <td>0.5~0.6</td> <td>0.3~0.4</td> <td>0.15~0.25</td> </tr> <tr> <td>d</td> <td>1.0</td> <td>0.64</td> <td>0.45</td> </tr> </tbody> </table> 	Type	107	212	316	325	Size	L	1.6	2.0	3.2	3.2	W	0.8	1.25	1.6	2.5	A	0.8~1.0	1.0~1.4	1.8~2.5	1.8~2.5	B	0.5~0.8	0.8~1.5	0.8~1.7	0.8~1.7	C	0.6~0.8	0.9~1.2	1.2~1.6	1.8~2.5	Type	042	063	105	107	212	316	325	432	Size	L	0.4	0.6	1.0	1.6	2.0	3.2	3.2	4.5	W	0.2	0.3	0.5	0.8	1.25	1.6	2.5	3.2	A	0.15~0.25	0.20~0.30	0.45~0.55	0.6~0.8	0.8~1.2	1.8~2.5	1.8~2.5	2.5~3.5	B	0.10~0.20	0.20~0.30	0.40~0.50	0.6~0.8	0.8~1.2	1.0~1.5	1.0~1.5	1.5~1.8	C	0.15~0.30	0.25~0.40	0.45~0.55	0.6~0.8	0.9~1.6	1.2~2.0	1.8~3.2	2.3~3.5	Type	212 (4 circuits)	Size	L	2.0	W	1.25	a	0.5~0.6	b	0.5~0.6	c	0.2~0.3	d	0.5	Type	212 (2 circuits)	110 (2 circuits)	096 (2 circuits)	Size	L	2.0	1.37	0.9	W	1.25	1.0	0.6	a	0.5~0.6	0.35~0.45	0.25~0.35	b	0.5~0.6	0.55~0.65	0.15~0.25	c	0.5~0.6	0.3~0.4	0.15~0.25	d	1.0	0.64	0.45
Type	107	212	316	325																																																																																																																																
Size	L	1.6	2.0	3.2	3.2																																																																																																																															
	W	0.8	1.25	1.6	2.5																																																																																																																															
A	0.8~1.0	1.0~1.4	1.8~2.5	1.8~2.5																																																																																																																																
B	0.5~0.8	0.8~1.5	0.8~1.7	0.8~1.7																																																																																																																																
C	0.6~0.8	0.9~1.2	1.2~1.6	1.8~2.5																																																																																																																																
Type	042	063	105	107	212	316	325	432																																																																																																																												
Size	L	0.4	0.6	1.0	1.6	2.0	3.2	3.2	4.5																																																																																																																											
	W	0.2	0.3	0.5	0.8	1.25	1.6	2.5	3.2																																																																																																																											
A	0.15~0.25	0.20~0.30	0.45~0.55	0.6~0.8	0.8~1.2	1.8~2.5	1.8~2.5	2.5~3.5																																																																																																																												
B	0.10~0.20	0.20~0.30	0.40~0.50	0.6~0.8	0.8~1.2	1.0~1.5	1.0~1.5	1.5~1.8																																																																																																																												
C	0.15~0.30	0.25~0.40	0.45~0.55	0.6~0.8	0.9~1.6	1.2~2.0	1.8~3.2	2.3~3.5																																																																																																																												
Type	212 (4 circuits)																																																																																																																																			
Size	L	2.0																																																																																																																																		
	W	1.25																																																																																																																																		
a	0.5~0.6																																																																																																																																			
b	0.5~0.6																																																																																																																																			
c	0.2~0.3																																																																																																																																			
d	0.5																																																																																																																																			
Type	212 (2 circuits)	110 (2 circuits)	096 (2 circuits)																																																																																																																																	
Size	L	2.0	1.37	0.9																																																																																																																																
	W	1.25	1.0	0.6																																																																																																																																
a	0.5~0.6	0.35~0.45	0.25~0.35																																																																																																																																	
b	0.5~0.6	0.55~0.65	0.15~0.25																																																																																																																																	
c	0.5~0.6	0.3~0.4	0.15~0.25																																																																																																																																	
d	1.0	0.64	0.45																																																																																																																																	

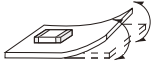
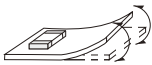
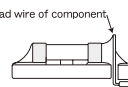
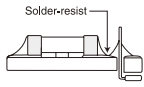
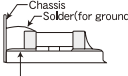
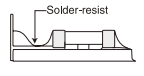
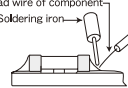
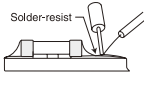
Precautions on the use of Multilayer Ceramic Capacitors

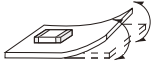
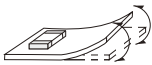
Stages	Precautions	Technical considerations																																																				
<p>2.PCB Design</p>	<p>Pattern configurations (Capacitor layout on panelized [breakaway] PC boards)</p> <p>1. After capacitors have been mounted on the boards, chips can be subjected to mechanical stresses in subsequent manufacturing processes (PCB cutting, board inspection, mounting of additional parts, assembly into the chassis, wave soldering the reflow soldered boards etc.) For this reason, planning pattern configurations and the position of SMD capacitors should be carefully performed to minimize stress.</p>	<p>LWDC Recommended land dimensions for reflow-soldering</p>  <table border="1" data-bbox="853 469 1236 655"> <thead> <tr> <th>Type</th> <th>105</th> <th>107</th> <th>212</th> <th>316</th> </tr> </thead> <tbody> <tr> <td rowspan="2">Size</td> <td>W</td> <td>1.0</td> <td>1.6</td> <td>2.0</td> <td>3.2</td> </tr> <tr> <td>L</td> <td>0.52</td> <td>0.8</td> <td>1.25</td> <td>1.6</td> </tr> <tr> <td>A</td> <td>0.18~0.22</td> <td>0.25~0.3</td> <td>0.5~0.7</td> <td>0.8~1.0</td> </tr> <tr> <td>B</td> <td>0.2~0.25</td> <td>0.3~0.4</td> <td>0.4~0.5</td> <td>0.4~0.5</td> </tr> <tr> <td>C</td> <td>0.9~1.1</td> <td>1.5~1.7</td> <td>1.9~2.1</td> <td>3.0~3.4</td> </tr> </tbody> </table> <p>(unit: mm)</p> <p>(2) Examples of good and bad solder application</p> <table border="1" data-bbox="845 753 1452 1190"> <thead> <tr> <th>Items</th> <th>Not recommended</th> <th>Recommended</th> </tr> </thead> <tbody> <tr> <td>Mixed mounting of SMD and leaded components</td> <td></td> <td></td> </tr> <tr> <td>Component placement close to the chassis</td> <td></td> <td></td> </tr> <tr> <td>Hand-soldering of leaded components near mounted components</td> <td></td> <td></td> </tr> <tr> <td>Horizontal component placement</td> <td></td> <td></td> </tr> </tbody> </table> <p>1-1. The following are examples of good and bad capacitor layout; SMD capacitors should be located to minimize any possible mechanical stresses from board warp or deflection.</p> <table border="1" data-bbox="845 1299 1452 1452"> <thead> <tr> <th></th> <th>Not recommended</th> <th>Recommended</th> </tr> </thead> <tbody> <tr> <td>Deflection of the board</td> <td></td> <td></td> </tr> </tbody> </table> <p>1-2. To layout the capacitors for the breakaway PC board, it should be noted that the amount of mechanical stresses given will vary depending on capacitor layout. The example below shows recommendations for better design.</p>  <p>Magnitude of stress $A > B = C > D > E$</p> <p>1-3. When breaking PC boards along their perforations, the amount of mechanical stress on the capacitors can vary according to the method used. The following methods are listed in order from least stressful to most stressful: push-back, slit, V-grooving, and perforation. Thus, any ideal SMD capacitor layout must also consider the PCB splitting procedure.</p>	Type	105	107	212	316	Size	W	1.0	1.6	2.0	3.2	L	0.52	0.8	1.25	1.6	A	0.18~0.22	0.25~0.3	0.5~0.7	0.8~1.0	B	0.2~0.25	0.3~0.4	0.4~0.5	0.4~0.5	C	0.9~1.1	1.5~1.7	1.9~2.1	3.0~3.4	Items	Not recommended	Recommended	Mixed mounting of SMD and leaded components			Component placement close to the chassis			Hand-soldering of leaded components near mounted components			Horizontal component placement				Not recommended	Recommended	Deflection of the board		
Type	105	107	212	316																																																		
Size	W	1.0	1.6	2.0	3.2																																																	
	L	0.52	0.8	1.25	1.6																																																	
A	0.18~0.22	0.25~0.3	0.5~0.7	0.8~1.0																																																		
B	0.2~0.25	0.3~0.4	0.4~0.5	0.4~0.5																																																		
C	0.9~1.1	1.5~1.7	1.9~2.1	3.0~3.4																																																		
Items	Not recommended	Recommended																																																				
Mixed mounting of SMD and leaded components																																																						
Component placement close to the chassis																																																						
Hand-soldering of leaded components near mounted components																																																						
Horizontal component placement																																																						
	Not recommended	Recommended																																																				
Deflection of the board																																																						

Precautions on the use of Multilayer Ceramic Capacitors

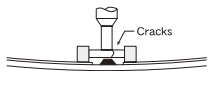
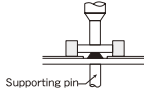
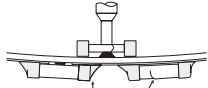
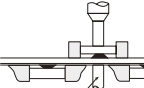
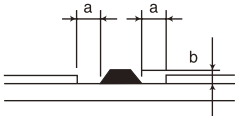
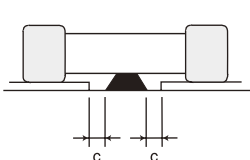
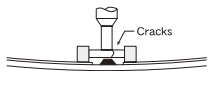
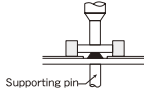
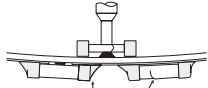
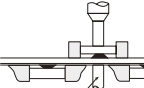
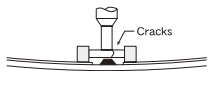
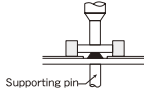
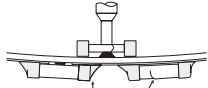
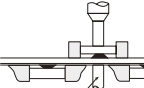
Stages	Precautions	Technical considerations																	
<p>3.Considerations for auto-matic placement</p>	<p>Adjustment of mounting machine</p> <ol style="list-style-type: none"> Excessive impact load should not be imposed on the capacitors when mounting onto the PC boards. The maintenance and inspection of the mounters should be conducted periodically. <p>Selection of Adhesives</p> <ol style="list-style-type: none"> Mounting capacitors with adhesives in preliminary assembly, before the soldering stage, may lead to degraded capacitor characteristics unless the following factors are appropriately checked; the size of land patterns, type of adhesive, amount applied, hardening temperature and hardening period. Therefore, it is imperative to consult the manufacturer of the adhesives on proper usage and amounts of adhesive to use. 	<ol style="list-style-type: none"> If the lower limit of the pick-up nozzle is low, too much force may be imposed on the capacitors, causing damage. To avoid this, the following points should be considered before lowering the pick-up nozzle: <ol style="list-style-type: none"> The lower limit of the pick-up nozzle should be adjusted to the surface level of the PC board after correcting for deflection of the board. The pick-up pressure should be adjusted between 1 and 3 N static loads. To reduce the amount of deflection of the board caused by impact of the pick-up nozzle, supporting pins or back-up pins should be used under the PC board. The following diagrams show some typical examples of good pick-up nozzle placement: <table border="1" data-bbox="849 526 1449 794"> <thead> <tr> <th></th> <th>Not recommended</th> <th>Recommended</th> </tr> </thead> <tbody> <tr> <td>Single-sided mounting</td> <td></td> <td></td> </tr> <tr> <td>Double-sided mounting</td> <td></td> <td></td> </tr> </tbody> </table> <ol style="list-style-type: none"> As the alignment pin wears out, adjustment of the nozzle height can cause chipping or cracking of the capacitors because of mechanical impact on the capacitors. To avoid this, the monitoring of the width between the alignment pin in the stopped position, and maintenance, inspection and replacement of the pin should be conducted periodically. Some adhesives may cause reduced insulation resistance. The difference between the shrinkage percentage of the adhesive and that of the capacitors may result in stresses on the capacitors and lead to cracking. Moreover, too little or too much adhesive applied to the board may adversely affect component placement, so the following precautions should be noted in the application of adhesives. <ol style="list-style-type: none"> Required adhesive characteristics <ol style="list-style-type: none"> The adhesive should be strong enough to hold parts on the board during the mounting & solder process. The adhesive should have sufficient strength at high temperatures. The adhesive should have good coating and thickness consistency. The adhesive should be used during its prescribed shelf life. The adhesive should harden rapidly The adhesive must not be contaminated. The adhesive should have excellent insulation characteristics. The adhesive should not be toxic and have no emission of toxic gasses. The recommended amount of adhesives is as follows; <table border="1" data-bbox="852 1469 1402 1589"> <thead> <tr> <th>Figure</th> <th>212/316 case sizes as examples</th> </tr> </thead> <tbody> <tr> <td>a</td> <td>0.3mm min</td> </tr> <tr> <td>b</td> <td>100 ~ 120 μm</td> </tr> <tr> <td>c</td> <td>Adhesives should not contact the pad</td> </tr> </tbody> </table> <div style="display: flex; justify-content: space-around; margin-top: 20px;"> <div data-bbox="874 1662 1109 1808"> <p>Amount of adhesive</p>  </div> <div data-bbox="1173 1662 1423 1852"> <p>After capacitors are bonded</p>  </div> </div>		Not recommended	Recommended	Single-sided mounting			Double-sided mounting			Figure	212/316 case sizes as examples	a	0.3mm min	b	100 ~ 120 μm	c	Adhesives should not contact the pad
	Not recommended	Recommended																	
Single-sided mounting																			
Double-sided mounting																			
Figure	212/316 case sizes as examples																		
a	0.3mm min																		
b	100 ~ 120 μm																		
c	Adhesives should not contact the pad																		

Precautions on the use of Multilayer Ceramic Capacitors

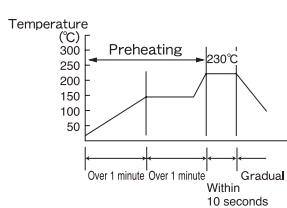
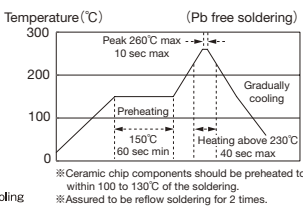
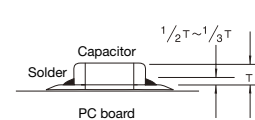
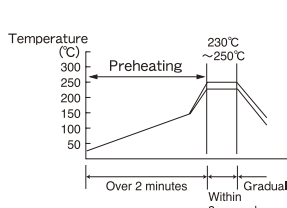
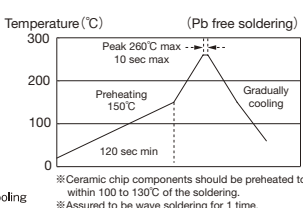
Stages	Precautions	Technical considerations
<p>4. Soldering</p>	<p>Selection of Flux</p> <p>1. Since flux may have a significant effect on the performance of capacitors, it is necessary to verify the following conditions prior to use;</p> <p>(1) Flux used should be with less than or equal to 0.1 wt% (equivalent to chlorine) of halogenated content. Flux having a strong acidity content should not be applied.</p> <p>(2) When soldering capacitors on the board, the amount of flux applied should be controlled at the optimum level.</p> <p>(3) When using water-soluble flux, special care should be taken to properly clean the boards.</p> <p>Soldering</p> <p>Temperature, time, amount of solder, etc. are specified in accordance with the following recommended conditions.</p> <p>Sn-Zn solder paste can affect MLCC reliability performance. Please contact us prior to usage.</p>	<p>1-1. When too much halogenated substance (Chlorine, etc.) content is used to activate the flux, or highly acidic flux is used, an excessive amount of residue after soldering may lead to corrosion of the terminal electrodes or degradation of insulation resistance on the surface of the capacitors.</p> <p>1-2. Flux is used to increase solderability in flow soldering, but if too much is applied, a large amount of flux gas may be emitted and may detrimentally affect solderability. To minimize the amount of flux applied, it is recommended to use a flux-bubbling system.</p> <p>1-3. Since the residue of water-soluble flux is easily dissolved by water content in the air, the residue on the surface of capacitors in high humidity conditions may cause a degradation of insulation resistance and therefore affect the reliability of the components. The cleaning methods and the capability of the machines used should also be considered carefully when selecting water-soluble flux.</p> <p>1-1. Preheating when soldering</p> <p>Heating: Ceramic chip components should be preheated to within 100 to 130°C of the soldering.</p> <p>Cooling: The temperature difference between the components and cleaning process should not be greater than 100°C.</p> <p>Ceramic chip capacitors are susceptible to thermal shock when exposed to rapid or concentrated heating or rapid cooling. Therefore, the soldering process must be conducted with great care so as to prevent malfunction of the components due to excessive thermal shock.</p> <p>Recommended conditions for soldering</p> <p>[Reflow soldering]</p> <p>Temperature profile</p>   <p>Caution</p> <p>1. The ideal condition is to have solder mass (fillet) controlled to 1/2 to 1/3 of the thickness of the capacitor, as shown below:</p>  <p>2. Because excessive dwell times can detrimentally affect solderability, soldering duration should be kept as close to recommended times as possible.</p> <p>[Wave soldering]</p> <p>Temperature profile</p>   <p>Caution</p> <p>1. Make sure the capacitors are preheated sufficiently.</p> <p>2. The temperature difference between the capacitor and melted solder should not be greater than 100 to 130°C</p> <p>3. Cooling after soldering should be as gradual as possible.</p> <p>4. Wave soldering must not be applied to the capacitors designated as for reflow soldering only.</p>

Precautions on the use of Multilayer Ceramic Capacitors

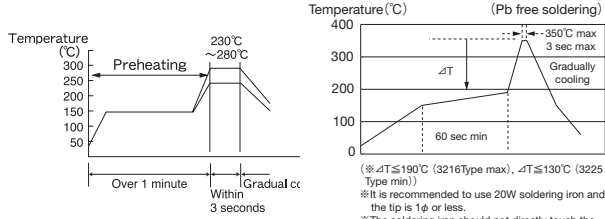
Stages	Precautions	Technical considerations
4. Soldering		<p>[Hand soldering]</p> <p>Temperature profile</p>  <p>Caution</p> <ol style="list-style-type: none"> 1. Use a 20W soldering iron with a maximum tip diameter of 1.0 mm. 2. The soldering iron should not directly touch the capacitor.
5. Cleaning	<p>Cleaning conditions</p> <ol style="list-style-type: none"> 1. When cleaning the PC board after the capacitors are all mounted, select the appropriate cleaning solution according to the type of flux used and purpose of the cleaning (e.g. to remove soldering flux or other materials from the production process.) 2. Cleaning conditions should be determined after verifying, through a test run, that the cleaning process does not affect the capacitor's characteristics. 	<ol style="list-style-type: none"> 1. The use of inappropriate solutions can cause foreign substances such as flux residue to adhere to the capacitor or deteriorate the capacitor's outer coating, resulting in a degradation of the capacitor's electrical properties (especially insulation resistance). 2. Inappropriate cleaning conditions (insufficient or excessive cleaning) may detrimentally affect the performance of the capacitors. <p>(1) Excessive cleaning</p> <p>In the case of ultrasonic cleaning, too much power output can cause excessive vibration of the PC board which may lead to the cracking of the capacitor or the soldered portion, or decrease the terminal electrodes' strength. Thus the following conditions should be carefully checked;</p> <p>Ultrasonic output Below 20 W/ℓ Ultrasonic frequency Below 40 kHz Ultrasonic washing period 5 min. or less</p>
6. Post cleaning processes	<ol style="list-style-type: none"> 1. With some type of resins a decomposition gas or chemical reaction vapor may remain inside the resin during the hardening period or while left under normal storage conditions resulting in the deterioration of the capacitor's performance. 2. When a resin's hardening temperature is higher than the capacitor's operating temperature, the stresses generated by the excess heat may lead to capacitor damage or destruction. The use of such resins, molding materials etc. is not recommended. 	
7. Handling	<p>Breakaway PC boards (splitting along perforations)</p> <ol style="list-style-type: none"> 1. When splitting the PC board after mounting capacitors and other components, care is required so as not to give any stresses of deflection or twisting to the board. 2. Board separation should not be done manually, but by using the appropriate devices. <p>Mechanical considerations</p> <ol style="list-style-type: none"> 1. Be careful not to subject the capacitors to excessive mechanical shocks. <ol style="list-style-type: none"> (1) If ceramic capacitors are dropped onto the floor or a hard surface, they should not be used. (2) When handling the mounted boards, be careful that the mounted components do not come in contact with or bump against other boards or components. 	

Precautions on the use of Multilayer Ceramic Capacitors

Stages	Precautions	Technical considerations
8.Storage conditions	<p>Storage</p> <p>1. To maintain the solderability of terminal electrodes and to keep the packaging material in good condition, care must be taken to control temperature and humidity in the storage area. Humidity should especially be kept as low as possible.</p> <ul style="list-style-type: none"> • Recommended conditions <ul style="list-style-type: none"> Ambient temperature Below 30°C Humidity Below 70% RH <p>The ambient temperature must be kept below 40°C. Even under ideal storage conditions capacitor electrode solderability decreases as time passes, so should be used within 6 months from the time of delivery.</p> <ul style="list-style-type: none"> • Ceramic chip capacitors should be kept where no chlorine or sulfur exists in the air. <p>2. The capacitance value of high dielectric constant capacitors (type 2 &3) will gradually decrease with the passage of time, so this should be taken into consideration in the circuit design. If such a capacitance reduction occurs, a heat treatment of 150°C for 1hour will return the capacitance to its initial level.</p>	<p>1. If the parts are stored in a high temperature and humidity environment, problems such as reduced solderability caused by oxidation of terminal electrodes and deterioration of taping/package materials may take place. For this reason, components should be used within 6 months from the time of delivery. If exceeding the above period, please check solderability before using the capacitors.</p>