

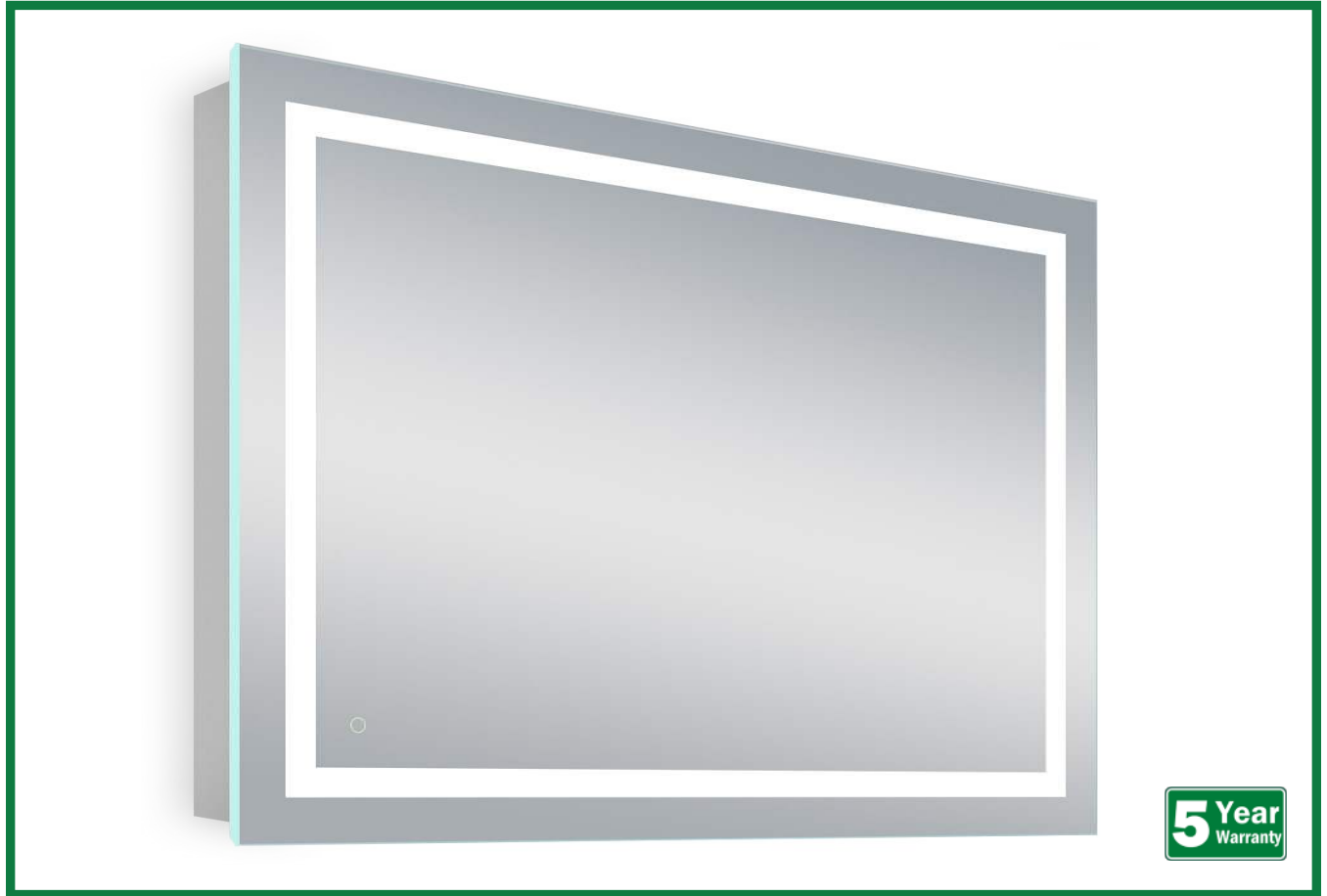

LED Vanity Mirrors

Fame Series



Beyond LED's Fame Series LED Vanity Mirrors are the most advanced and unique product of 2021. Fame Series Mirrors are CCT Adjustable, controlled with a round touch button, and have an Integrated Defogger. Fame Series Mirrors are easy to surface mount and include all installation hardware. These are high quality polished edge mirrors that are sure to make anyone look their best.

- Integrated touch sensor control with memory
- Energy efficient LED lighting
- CCT Adjustable 3000k- 6000k
- Integrated Defogger
- 100-120Vac Input Voltage
- High CRI 90+

LED Vanity Mirrors

Fame Series

SKU #	Model #	Watts	Lumens	CCT	CRI	Size	Input Voltage	Certifications
151730	BLT-ICON2432	49.6W	2700Lm	Adjustable 3000K/4000K/5000K	>90	24" X 32"	100-120Vac	ETL
151731	BLT-ICON2436	51.6W	2900Lm	Adjustable 3000K/4000K/5000K	>90	24" X 36"	100-120Vac	ETL
151732	BLT-ICON3636	68.4W	3500Lm	Adjustable 3000K/4000K/5000K	>90	36" X 36"	100-120Vac	ETL
151733	BLT-ICON3648	74.4W	4290Lm	Adjustable 3000K/4000K/5000K	>90	36" X 48"	100-120Vac	ETL
151738	BLT-ICON3648	73.9W	4200Lm	Adjustable 3000K/4000K/5000K	>90	36" X 48"	100-120Vac	ETL

Integrated Defogger



3000K/4000K/5000K

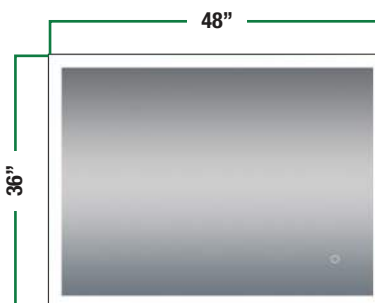
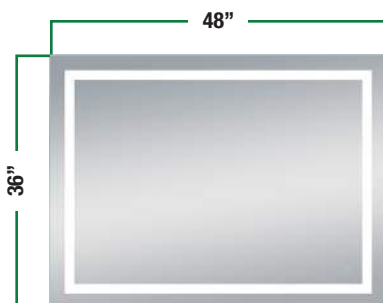
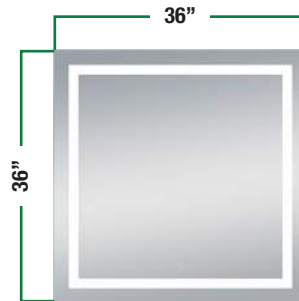
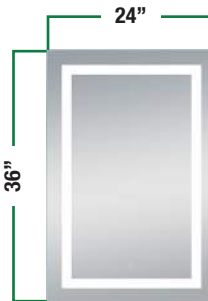
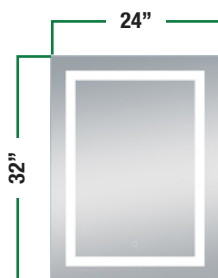

Integrated Touch Sensor Control with Memory

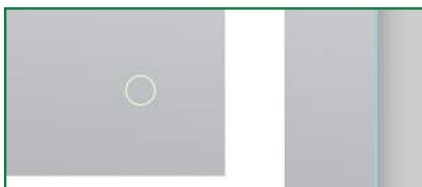

Polished Edge Border Window Style



Polished Edge Inner Window Style



(866) 786-1117 • www.BeyondLEDTechnology.com

Due to continuous product improvement, information in this document is subject to change.

LED Vanity Mirrors

Fame Series

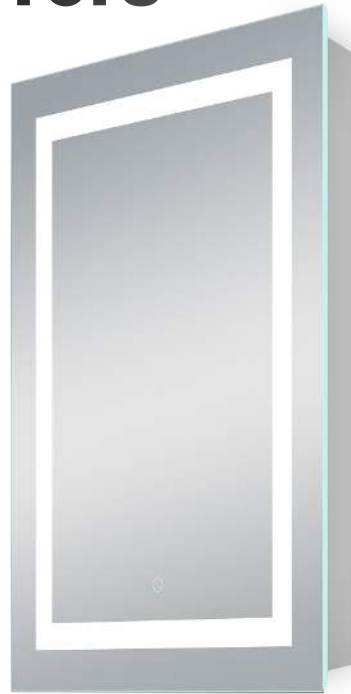

24" X 32" Specifications - 151730

- Integrated touch sensor control with memory
- Energy efficient LED lighting 3000 - 6000K
- 2700 Lumens
- CRI 90+
- Integrated Defogger
- Quality polished edge mirror
- Single phase wire installation, silver backed, copper free
- Construction for surface mounting
- Includes installation hardware

	Wattage	49.6W	
Size	24"x32"	Lumens	2700LM
CCT	3000 - 6000K	Input Voltage	100-120VAC
CRI	>90	LED/Meter	2.55

Dimensions

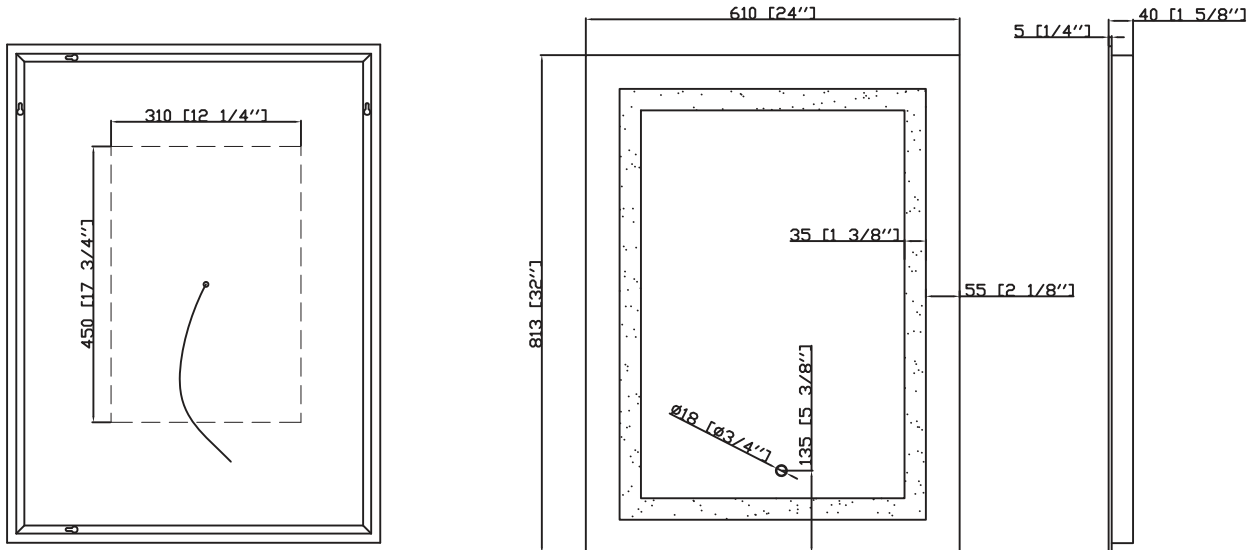

LED Vanity Mirrors

Fame Series



24" X 36" Specifications - 151731

- Integrated touch sensor control with memory
- Energy efficient LED lighting 3000 - 6000K
- 2900 Lumens
- CRI 90+
- Integrated Defogger
- Quality polished edge mirror
- Single phase wire installation, silver backed, copper free
- Construction for surface mounting
- Includes installation hardware

	Wattage	51.6W	
Size	24"x36"	Lumens	2900LM
CCT	3000 - 6000K	Input Voltage	100-120VAC
CRI	>90	LED/Meter	2.75

Dimensions

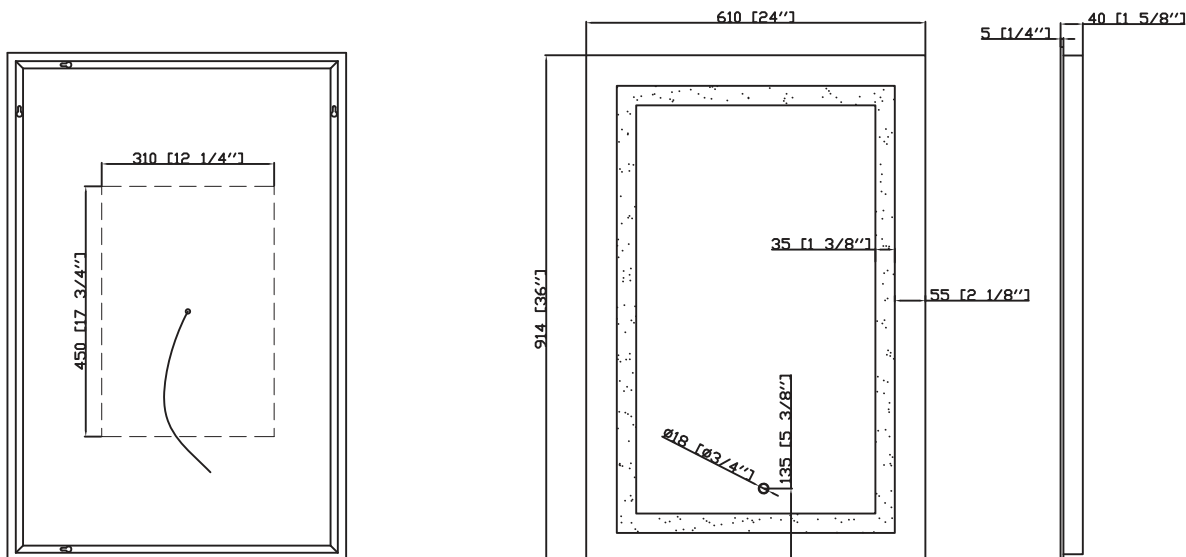

(866) 786-1117 • www.BeyondLEDTechnology.com

Due to continuous product improvement, information in this document is subject to change.

LED Vanity Mirrors

Fame Series

36" X 36" Specifications - 151732

- Integrated touch sensor control with memory
- Energy efficient LED lighting 3000 - 6000K
- 3600 Lumens
- CRI 90+
- Integrated Defogger
- Quality polished edge mirror
- Single phase wire installation, silver backed, copper free
- Construction for surface mounting
- Includes installation hardware

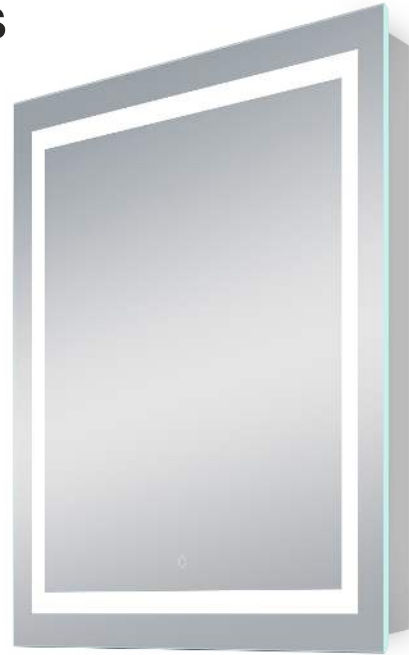

	Wattage	68.4W	
Size	36"x36"	Lumens	3600LM
CCT	3000 - 6000K	Input Voltage	100-120VAC
CRI	>90	LED/Meter	3.35

Dimensions

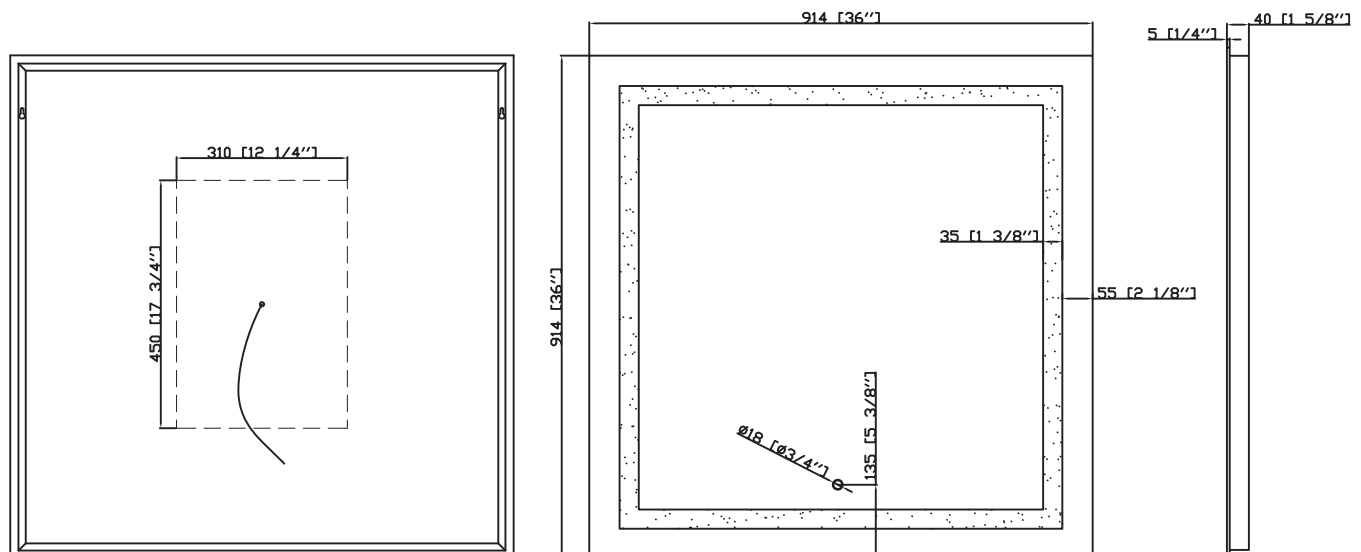

LED Vanity Mirrors

Fame Series

36" X 48" Specifications - 151733

- Integrated touch sensor control with memory
- Energy efficient LED lighting 3000 - 6000K
- 4290 Lumens
- CRI 90+
- Integrated Defogger
- Quality polished edge mirror
- Single phase wire installation, silver backed, copper free
- Construction for surface mounting
- Includes installation hardware

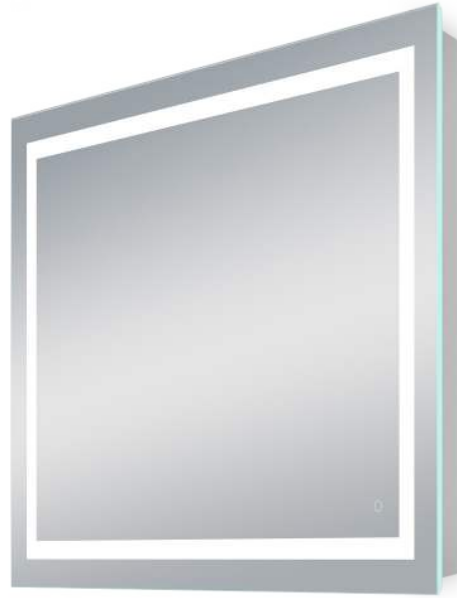

	Wattage	74.4W		
Size	36"x48"	Lumens	4290LM	
CCT	3000 - 6000K	Input Voltage	100-120VAC	
CRI	>90	LED/Meter	3.95	

Dimensions

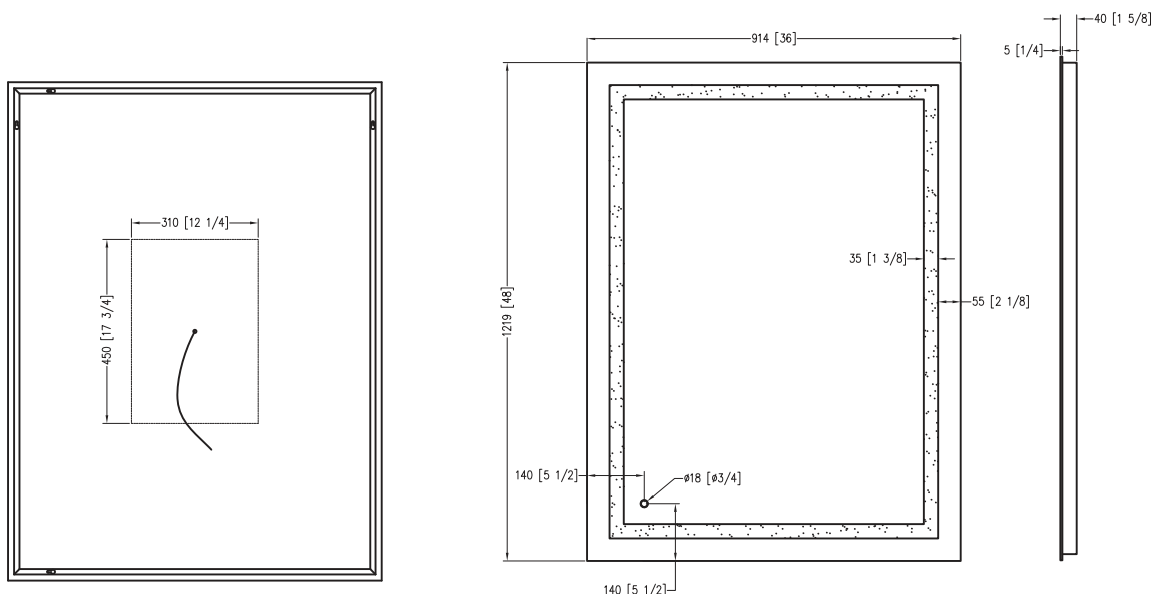

(866) 786-1117 • www.BeyondLEDTechnology.com

Due to continuous product improvement, information in this document is subject to change.

LED Vanity Mirrors

Fame Series

36" X 48" Specifications - 151738

- Integrated touch sensor control with memory
- Energy efficient LED lighting 3000 - 6000K
- 4200 Lumens
- CRI 90+
- Integrated Defogger
- Quality polished edge mirror
- Single phase wire installation, silver backed, copper free
- Construction for surface mounting
- Includes installation hardware



	Wattage	73.9W	
Size	36"x48"	Lumens	4200LM
CCT	3000 - 6000K	Input Voltage	100-120VAC
CRI	>90	LED/Meter	3.9

Dimensions

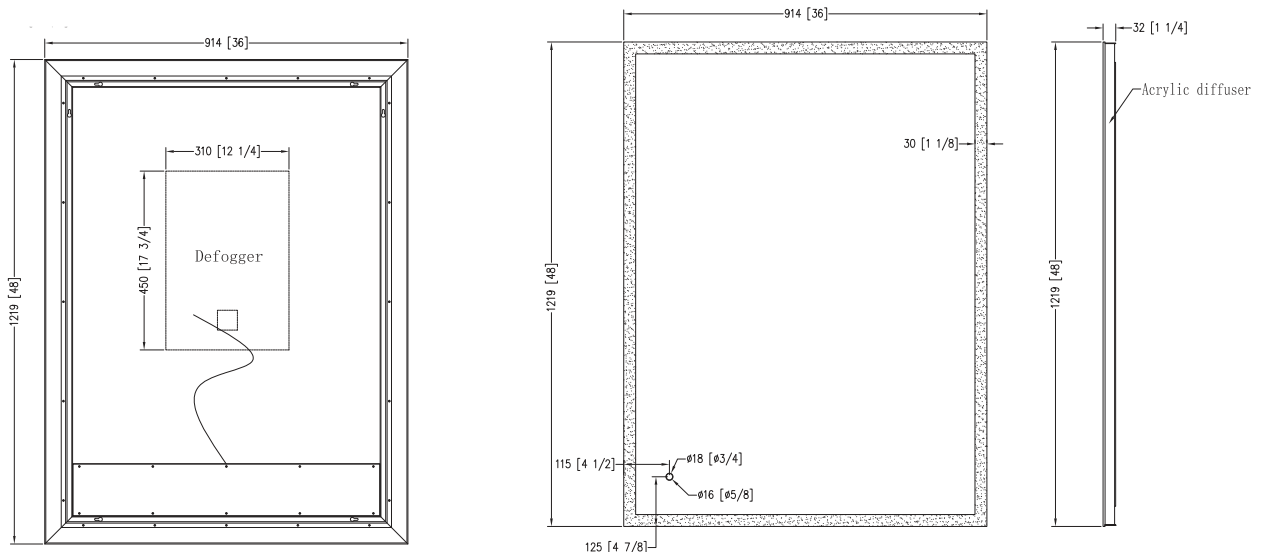

LED Vanity Mirrors

Fame Series

Application



LED Vanity Mirrors

Fame Series

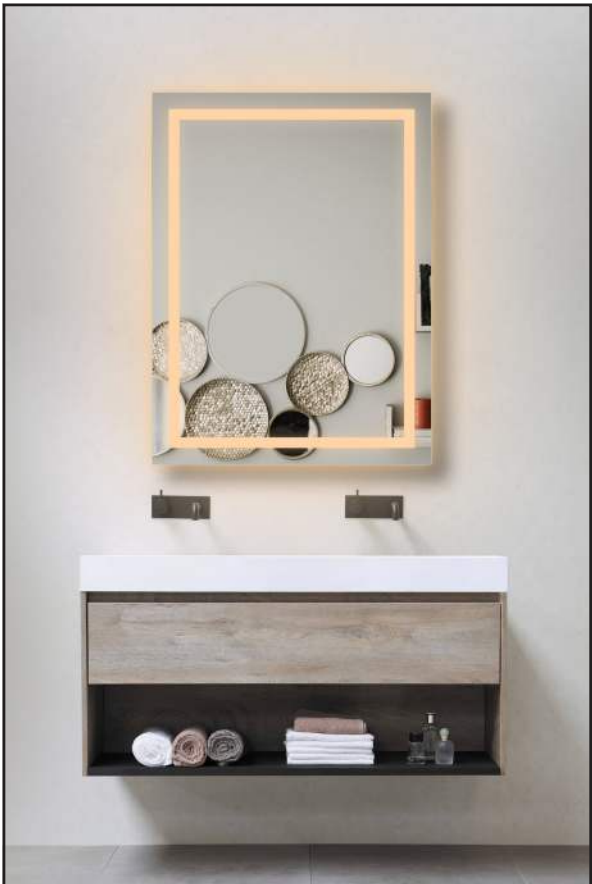

LED VANITY LIGHTING

LED Vanity Mirrors

Fame Series



LED VANITY LIGHTING

(866) 786-1117 • www.BeyondLEDTechnology.com

Due to continuous product improvement, information in this document is subject to change.

