

Low Noise, Low Drift, Low Power 3-Axis MEMS Accelerometer

FEATURES

- ▶ 0 g offset vs. temperature (all axes): 0.45 mg/°C typical
- ▶ Ultralow noise density (all axes): 80 µg/√Hz
- ▶ Low power, V_{SUPPLY} (LDO enabled)
 - ▶ In measurement mode: 200 µA
 - ▶ In standby mode: 21 µA
- ▶ Digital output features
 - ▶ Digital SPI and limited I²C interfaces supported
 - ▶ 20-bit ADC
 - ▶ Data interpolation routine for synchronous sampling
 - ▶ Programmable high-pass and low-pass digital filters
- ▶ Integrated temperature sensor
- ▶ Voltage range options
 - ▶ V_{SUPPLY} with internal regulators: 2.25 V to 3.6 V
 - ▶ V_{1P8ANA}, V_{1P8DIG} with internal LDO regulator bypassed: 1.8 V typical ± 10%
- ▶ Operating temperature range: -40°C to +125°C
- ▶ 14-terminal, 4 mm × 4 mm × 1.04 mm, LGA package

APPLICATIONS

- ▶ IMUs and altitude and heading reference systems (AHRs)
- ▶ Platform stabilization systems
- ▶ Vibration sensing
- ▶ Structural health monitoring
- ▶ Tilt sensing
- ▶ Robotics
- ▶ Condition monitoring

FUNCTIONAL BLOCK DIAGRAM

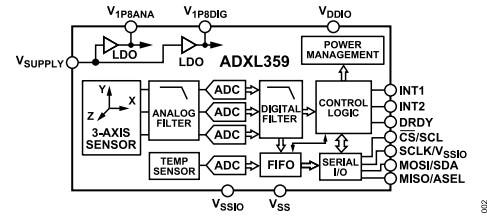

Figure 1. Functional Block Diagram

GENERAL DESCRIPTION

The digital output ADXL359¹ is a low noise density, low 0 g offset drift, low power, 3-axis microelectromechanical system (MEMS) accelerometer with selectable measurement ranges. The ADXL359 supports the ±10 g, ±20 g, and ±40 g ranges.

The ADXL359 offers industry leading noise, minimal offset drift over temperature, and long-term stability, enabling precision applications with minimal calibration.

The low drift, low noise, and low power ADXL359 enables accurate tilt measurement in an environment with high vibration, such as airborne inertial measurement units (IMUs). The low noise over higher frequencies is ideal for wireless condition monitoring.

The ADXL359 multifunction pin names may be referenced only by their relevant function for either the serial peripheral interface (SPI) or limited I²C interface.

¹ Protected by U.S. Patents 8,472,270; 9,041,462; 8,665,627; 8,917,099; 6,892,576; 9,297,825; and 7,956,621.

TABLE OF CONTENTS

Features.....	1	External Synchronization and Interpolation.....	22
Applications.....	1	Register Map.....	25
Functional Block Diagram.....	1	Register Definitions.....	26
General Description.....	1	Analog Devices ID Register.....	26
Specifications.....	3	Analog Devices MEMS ID Register.....	26
Digital Output.....	3	Device ID Register.....	26
SPI Characteristics.....	4	Product Revision ID Register.....	26
I ² C Digital Interface Characteristics.....	5	Status Register.....	26
Absolute Maximum Ratings.....	7	FIFO Entries Register.....	27
Thermal Resistance.....	7	Temperature Data Registers.....	27
Electrostatic Discharge (ESD) Ratings.....	7	X-Axis Data Registers.....	27
ESD Caution.....	7	Y-Axis Data Registers.....	28
Pin Configuration and Function Descriptions.....	8	Z-Axis Data Registers.....	28
Typical Performance Characteristics.....	9	FIFO Access Register.....	29
Theory of Operation.....	13	X-Axis Offset Trim Registers.....	29
Applications Information.....	14	Y-Axis Offset Trim Registers.....	29
Digital Output.....	14	Z-Axis Offset Trim Registers.....	30
Axes of Acceleration Sensitivity.....	14	Activity Enable Register.....	30
Power Sequencing.....	14	Activity Threshold Registers.....	30
Power Supply Description.....	14	Activity Count Register.....	31
Overrange Protection.....	14	Filter Settings Register.....	31
Self Test.....	15	FIFO Samples Register.....	31
Filter.....	15	Interrupt Pin (INTx) Function Map Register.....	32
Serial Communications.....	18	Data Synchronization.....	32
SPI Protocol.....	18	I ² C Speed, Interrupt Polarity, and Range	
I ² C Protocol.....	19	Register.....	32
Reading Acceleration or Temperature Data		Power Control Register.....	33
from the Interface.....	19	Self Test Register.....	33
FIFO.....	21	Reset Register.....	33
Interrupts.....	22	Recommended Soldering Profile.....	34
DATA_RDY.....	22	PCB Footprint Pattern.....	35
DRDY Pin.....	22	Outline Dimensions.....	36
FIFO_FULL.....	22	Ordering Guide.....	36
FIFO_OVR.....	22	Output Mode, Measurement Range, and	
Activity.....	22	Specified Voltage Options.....	36
NVM_BUSY.....	22	Evaluation Boards.....	36

REVISION HISTORY

6/2022—Revision 0: Initial Version

SPECIFICATIONS

DIGITAL OUTPUT

$T_A = 25^\circ\text{C}$, $V_{\text{SUPPLY}} = 3.3\text{ V}$, x-axis acceleration and y-axis acceleration = 0 g, z-axis acceleration = 1 g, full-scale range = $\pm 10\text{ g}$, and output data rate (ODR) = 500 Hz, unless otherwise noted. Note that multifunction pin names may be referenced only by their relevant function.

Table 1.

Parameter	Test Conditions/Comments	Min	Typ	Max	Unit
SENSOR INPUT	Each axis				
Output Full-Scale Range (FSR)	User selectable		± 10 ± 20 ± 40		g g g
Nonlinearity	$\pm 10\text{ g}$		0.1		% FSR
Cross Axis Sensitivity			1.5		%
SENSITIVITY	Each Axis				
X-Axis, Y-Axis, and Z-Axis Sensitivity	$\pm 10\text{ g}$ $\pm 20\text{ g}$ $\pm 40\text{ g}$		51,200 25,600 12,800		LSB/g LSB/g LSB/g
X-Axis, Y-Axis, and Z-Axis Scale Factor	$\pm 10\text{ g}$ $\pm 20\text{ g}$ $\pm 40\text{ g}$		19.5 39 78		$\mu\text{g}/\text{LSB}$ $\mu\text{g}/\text{LSB}$ $\mu\text{g}/\text{LSB}$
Sensitivity Change due to Temperature	$T_A = -40^\circ\text{C}$ to $+125^\circ\text{C}$		± 0.015		%/ $^\circ\text{C}$
0 g OFFSET	Each axis, $\pm 10\text{ g}$				
X-Axis, Y-Axis, and Z-Axis 0 g Output			± 125		mg
0 g Offset vs. Temperature (X-Axis, Y-Axis, and Z-Axis) ¹	$T_A = -40^\circ\text{C}$ to $+125^\circ\text{C}$		± 0.45		mg/ $^\circ\text{C}$
Vibration Rectification Error (VRE) ²	Offset due to 7.5 g rms vibration, $\pm 10\text{ g}$ range, in a 1 g orientation		<0.1		g
NOISE DENSITY	$\pm 10\text{ g}$				
X-Axis, Y-Axis, and Z-Axis			80		$\mu\text{g}/\sqrt{\text{Hz}}$
OUTPUT DATA RATE AND BANDWIDTH					
Analog-to-Digital Converter (ADC) Resolution			20		Bits
Low-Pass Filter (LPF) Pass Band Frequency	User programmable, Register 0x28	1		1000	Hz
High-Pass Filter (HPF) Pass Band Frequency When Enabled (Disabled by Default)	User programmable, Register 0x28 for 4 kHz ODR	0.0095		10	Hz
SELF TEST					
Output Change					
X-Axis	$\pm 10\text{ g}$ range	0.05	0.23	0.4	g
Y-Axis	$\pm 10\text{ g}$ range	0.05	0.23	0.4	g
Z-Axis	$\pm 10\text{ g}$ range	1.0	1.64	2.2	g
POWER SUPPLY					
Voltage Range					
V_{SUPPLY} Operating ³		2.25	2.5	3.6	V
V_{DDIO}		V_{1P8DIG}	2.5	3.6	V
V_{1P8ANA} and V_{1P8DIG} with Internal Low Dropout (LDO) Regulator Bypassed	$V_{\text{SUPPLY}} = 0\text{ V}$	1.62	1.8	1.98	V
Current					
Measurement Mode					
V_{SUPPLY} (LDO Enabled)			200		μA
V_{1P8ANA} (LDO Disabled)			160		μA
V_{1P8DIG} (LDO Disabled)			35.5		μA
Standby Mode					
V_{SUPPLY} (LDO Enabled)			21		μA

SPECIFICATIONS

Table 1.

Parameter	Test Conditions/Comments	Min	Typ	Max	Unit
V_{1P8ANA} (LDO Disabled)			7		μA
V_{1P8DIG} (LDO Disabled)			10		μA
Turn-On Time ⁴	$\pm 10\text{ g}$ range Power-off to standby		<10		ms
			<10		ms
TEMPERATURE SENSOR					
Output at 25°C			1852		LSB
Scale Factor			-9.05		LSB/°C
TEMPERATURE					
Operating Range		-40		+125	°C

¹ The temperature change is -40°C to $+25^\circ\text{C}$ or $+25^\circ\text{C}$ to $+125^\circ\text{C}$.

² The VRE measurement is the shift in dc offset while the device is subject to 12.5 g rms random vibration from 50 Hz to 2 kHz. The device under test (DUT) is configured for the $\pm 2\text{ g}$ range and an ODR of 4 kHz. The VRE scales with the range setting.

³ When V_{1P8ANA} and V_{1P8DIG} are generated internally, V_{SUPPLY} is valid. To disable the LDO regulator and drive V_{1P8ANA} and V_{1P8DIG} externally, connect V_{SUPPLY} to V_{SS} .

⁴ Standby to measurement mode; valid when the output is within 1 mg of the final value.

SPI CHARACTERISTICS

Table 2.

Parameter	Symbols	Test Conditions/Comments	Min	Typ	Max	Unit
DC INPUT LEVELS						
Input Voltage						
Low Level	V_{IL}				$0.3 \times V_{\text{DDIO}}$	V
High Level	V_{IH}		$0.7 \times V_{\text{DDIO}}$			V
Input Current						
Low Level	I_{IL}	Input voltage ($V_{\text{IN}} = 0\text{ V}$)	-0.1			μA
High Level	I_{IH}	$V_{\text{IN}} = V_{\text{DDIO}}$			0.1	μA
DC OUTPUT LEVELS						
Output Voltage						
Low Level	V_{OL}	$I_{\text{OL}} = I_{\text{OL, MIN}}$			$0.2 \times V_{\text{DDIO}}$	V
High Level	V_{OH}	$I_{\text{OH}} = I_{\text{OH, MAX}}$	$0.8 \times V_{\text{DDIO}}$			V
Output Current						
Low Level	I_{OL}	$V_{\text{OL}} = V_{\text{OL, MAX}}$	-10			mA
High Level	I_{OH}	$V_{\text{OH}} = V_{\text{OH, MIN}}$			4	mA
AC INPUT LEVELS						
SCLK Frequency			0.1		10	MHz
SCLK High Time	t_{HIGH}		40			ns
SCLK Low Time	t_{LOW}		40			ns
$\overline{\text{CS}}$ Setup Time	t_{CSS}		20			ns
$\overline{\text{CS}}$ Hold Time	t_{CSH}		20			ns
$\overline{\text{CS}}$ Disable Time	t_{CSD}		40			ns
Rising SCLK Setup Time	t_{SCLKS}		20			ns
MOSI Setup Time	t_{SU}		20			ns
MOSI Hold Time	t_{HD}		20			ns
AC OUTPUT LEVELS						
Propagation Delay	t_{p}	Load capacitance ($C_{\text{LOAD}} = 30\text{ pF}$)			30	ns
Enable MISO Time	t_{EN}		30			ns
Disable MISO Time	t_{DIS}				20	ns

SPECIFICATIONS

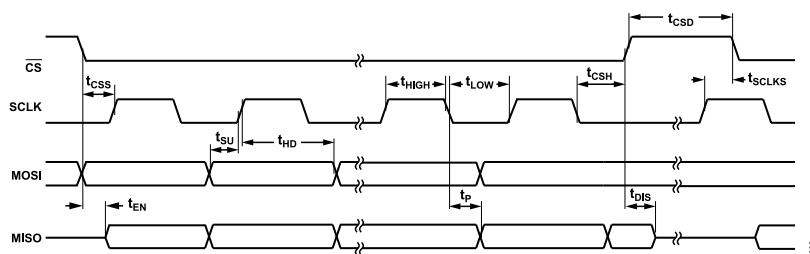

Figure 2. SPI Timing Diagram

I²C DIGITAL INTERFACE CHARACTERISTICS

Note that multifunction pin names may be referenced only by their relevant function.

Table 3.

Parameter	Symbol	Test Conditions/ Comments	I ² C_HS = 0 (Fast Mode)			I ² C_HS = 1 (High Speed Mode)			Unit
			Min	Typ	Max	Min	Typ	Max	
DC INPUT LEVELS									
Input Voltage									
Low Level	V _{IL}				0.3 × V _{DDIO}		0.3 × V _{DDIO}		V
High Level	V _{IH}		0.7 × V _{DDIO}			0.7 × V _{DDIO}			V
Hysteresis of Schmitt Triggered Inputs	V _{HYS}		0.05 × V _{DDIO}			0.1 × V _{DDIO}			V
Input Current	I _{IL}	0.1 × V _{DDIO} < V _{IN} < 0.9 × V _{DDIO}	-10		+10				μA
DC OUTPUT LEVELS									
Output Voltage		I _{OL} = 3 mA							
Low Level	V _{OL1}	V _{DDIO} > 2 V			0.4		0.4		V
	V _{OL2}	V _{DDIO} ≤ 2 V			0.2 × V _{DDIO}		0.2 × V _{DDIO}		V
Output Current									
Low Level	I _{OL}	V _{OL} = 0.4 V	20			20			mA
		V _{OL} = 0.6 V	6			6			mA
AC INPUT LEVELS									
SCL Frequency			0		1	0		3.4	MHz
SCL High Time	t _{HIGH}		260			60			ns
SCL Low Time	t _{LOW}		500			160			ns
Start Setup Time	t _{SUSTA}		260			160			ns
Start Hold Time	t _{HDSTA}		260			160			ns
SDA Setup Time	t _{SUDAT}		50			10			ns
SDA Hold Time	t _{HDDAT}		0			0			ns
Stop Setup Time	t _{SUSTO}		260			160			ns
Bus Free Time	t _{BUF}		500						ns
SCL Input Rise Time	t _{RCL}				120		80		ns
SCL Input Fall Time	t _{FCL}				120		80		ns
SDA Input Rise Time	t _{RDA}				120		160		ns
SDA Input Fall Time	t _{FDA}				120		160		ns
Width of Spikes to Suppress	t _{SP}	Not shown in Figure 3			50		10		ns
AC OUTPUT LEVELS									
Propagation Delay		C _{LOAD} = 500 pF							
Data	t _{VDDAT}		97		450	27		135	ns

SPECIFICATIONS

Table 3.

Parameter	Symbol	Test Conditions/ Comments	I2C_HS = 0 (Fast Mode)			I2C_HS = 1 (High Speed Mode)			Unit
			Min	Typ	Max	Min	Typ	Max	
Acknowledge	t_{VDACK}				450			ns	
Output Fall Time	t_F	Not shown in Figure 3	$20 \times (V_{DDIO}/5.5)$		120			ns	

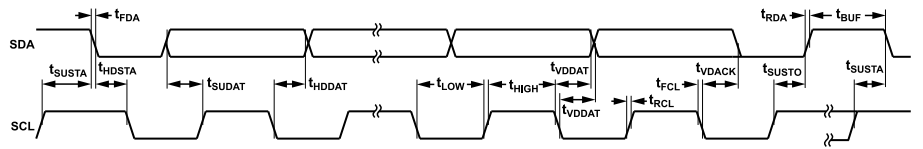

Figure 3. I²C Timing Diagram

ABSOLUTE MAXIMUM RATINGS

Table 4.

Parameter	Rating
Acceleration (Any Axis, 0.1 ms)	5000 g
V _{SUPPLY} and V _{DDIO}	5.4 V
V _{1P8ANA} and V _{1P8DIG} Configured as Inputs	1.98 V
Digital Pins (\overline{CS} /SCL, SCLK/V _{SSIO} , MOSI/SDA, MISO/ASEL, INT1, IN2, DRDY)	-0.3 V to V _{DDIO} + 0.3 V
Temperature Range	
Operating	-40°C to +125°C
Storage	-55°C to +150°C

Stresses at or above those listed under Absolute Maximum Ratings may cause permanent damage to the product. This is a stress rating only; functional operation of the product at these or any other conditions above those indicated in the operational section of this specification is not implied. Operation beyond the maximum operating conditions for extended periods may affect product reliability.

THERMAL RESISTANCE

Thermal performance is directly linked to printed circuit board (PCB) design and operating environment. Careful attention to PCB thermal design is required.

θ_{JA} is the natural convection junction to ambient thermal resistance measured in a one cubic foot sealed enclosure. ψ_{JB} is the junction to board thermal resistance.

Table 5. Thermal Resistance

Package Type ¹	θ_{JA}	ψ_{JB}	Unit
CC-14-2	79.10	41.76	°C/W

¹ Thermal impedance simulated values are based on a JEDEC 2S2P thermal test board with four thermal vias. See JEDEC JESD-51.

ELECTROSTATIC DISCHARGE (ESD) RATINGS

The following ESD information is provided for handling of ESD-sensitive devices in and ESD-protected area only.

Human body model (HBM) per ANSI/ESDA/JEDEC JESD22-A114.

Field induced charged-device model (FICDM) per ANSI/ESDA/JEDEC JESD22-C101.

ESD Ratings for the ADXL359

Table 6. ADXL359, 14-Terminal LGA

ESD Model	Withstand Threshold (V)	Class
FICDM	±1250	IV
HBM	±3500	2

ESD CAUTION



ESD (electrostatic discharge) sensitive device. Charged devices and circuit boards can discharge without detection. Although this product features patented or proprietary protection circuitry, damage may occur on devices subjected to high energy ESD. Therefore, proper ESD precautions should be taken to avoid performance degradation or loss of functionality.

PIN CONFIGURATION AND FUNCTION DESCRIPTIONS

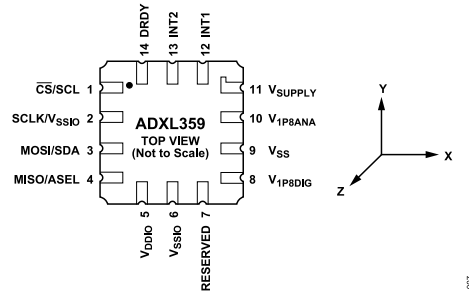

Figure 4. Pin Configuration

Table 7. Pin Function Descriptions

Pin No.	Mnemonic	Description
1	$\overline{\text{CS}}/\text{SCL}$	Chip Select for SPI ($\overline{\text{CS}}$). Serial Communications Clock for I ² C (SCL).
2	SCLK/V _{SSIO}	Serial Communications Clock for SPI (SCLK). I ² C Mode Enable (V _{SSIO}). Connect this pin to Pin 6 (V _{SSIO}) to enable I ² C mode.
3	MOSI/SDA	Controller Output, Subordinate Input for SPI (MOSI). Serial Data for I ² C (SDA).
4	MISO/ASEL	Controller Input, Subordinate Output for SPI (MISO). Alternate I ² C Address Select for I ² C (ASEL).
5	V _{DDIO}	Digital Interface Supply Voltage.
6	V _{SSIO}	Digital Ground.
7	RESERVED	Reserved. This pin can be connected to ground or left open.
8	V _{1P8DIG}	Digital Supply. This pin requires a decoupling capacitor. If V _{SUPPLY} connects to V _{SS} , supply the voltage to this pin externally.
9	V _{SS}	Analog Ground.
10	V _{1P8ANA}	Analog Supply. This pin requires a decoupling capacitor. If V _{SUPPLY} connects to V _{SS} , supply the voltage to this pin externally.
11	V _{SUPPLY}	Supply Voltage. When V _{SUPPLY} equals 2.25 V to 3.6 V, V _{SUPPLY} enables the internal LDO regulators to generate V _{1P8DIG} and V _{1P8ANA} . For V _{SUPPLY} = V _{SS} , V _{1P8DIG} and V _{1P8ANA} are externally supplied.
12	INT1	Interrupt Pin 1.
13	INT2	Interrupt Pin 2.
14	DRDY	Data Ready Pin.

TYPICAL PERFORMANCE CHARACTERISTICS

All figures include data for multiple devices and multiple lots, and these figures were taken in the $\pm 10\text{ g}$ range, unless otherwise noted.

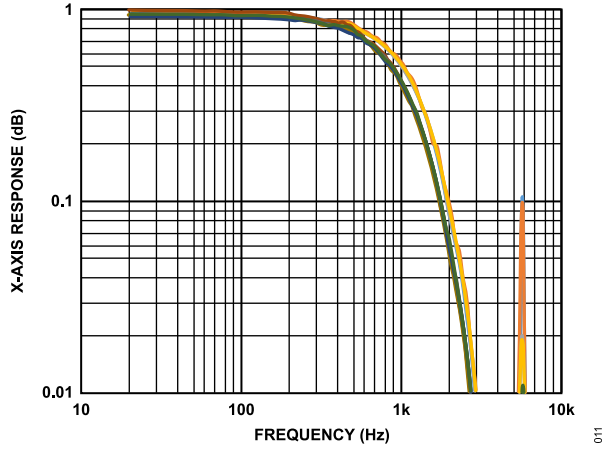

Figure 5. Normalized Frequency Response for X-Axis at 4 kHz ODR

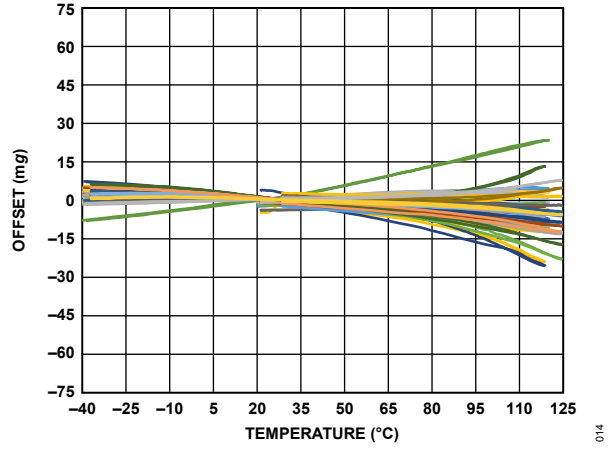

Figure 8. X-Axis Zero g Offset Normalized Relative to 25°C vs. Temperature

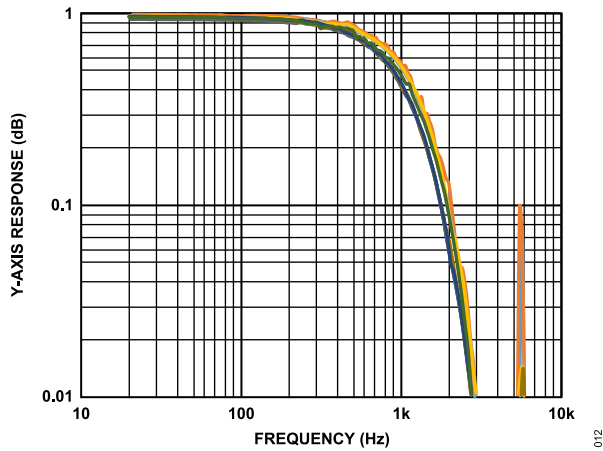

Figure 6. Normalized Frequency Response for Y-Axis at 4 kHz ODR

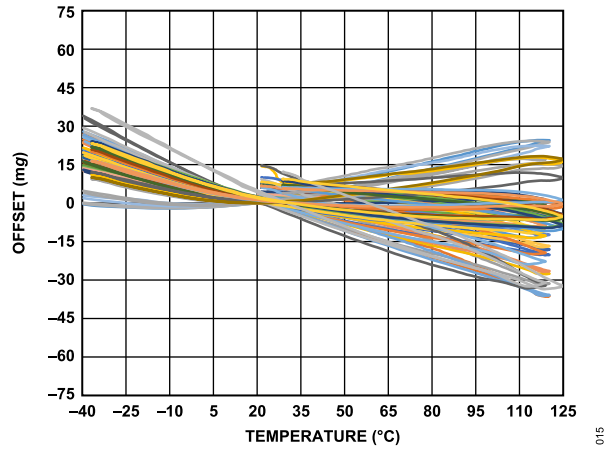

Figure 9. Y-Axis Zero g Offset Normalized Relative to 25°C vs. Temperature

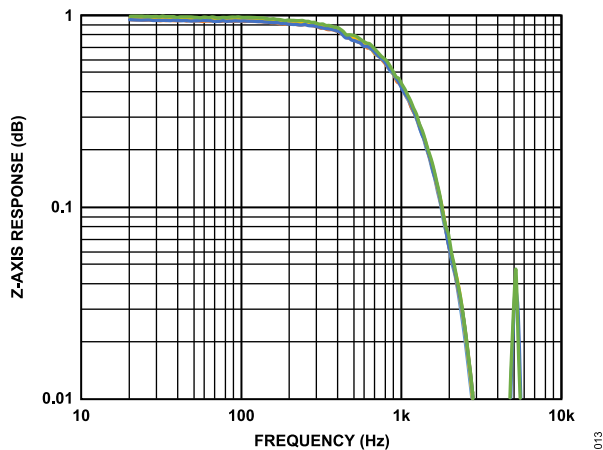

Figure 7. Normalized Frequency Response for Z-Axis at 4 kHz ODR

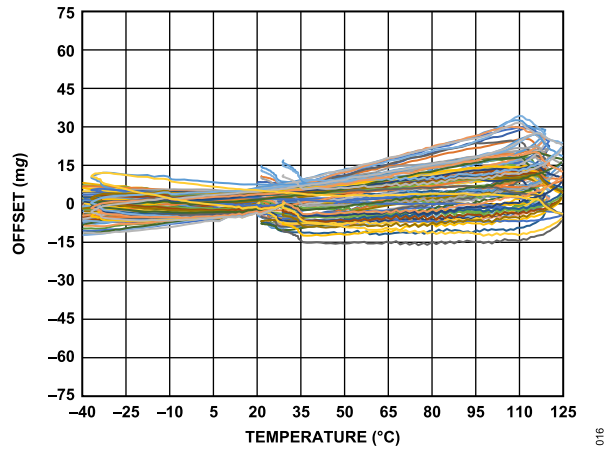

Figure 10. Z-Axis Zero g Offset Normalized Relative to 25°C vs. Temperature

TYPICAL PERFORMANCE CHARACTERISTICS

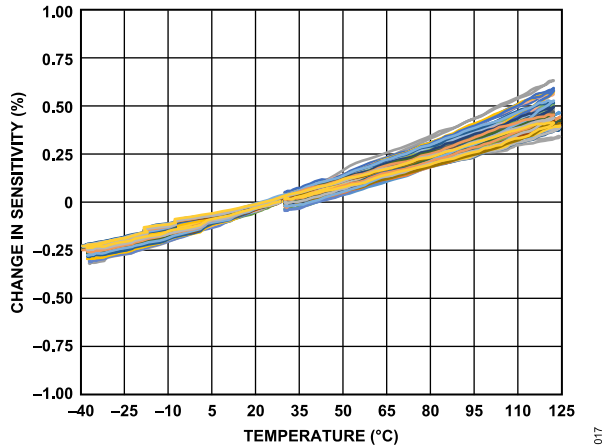

Figure 11. X-Axis Change in Sensitivity Relative to 25°C vs. Temperature

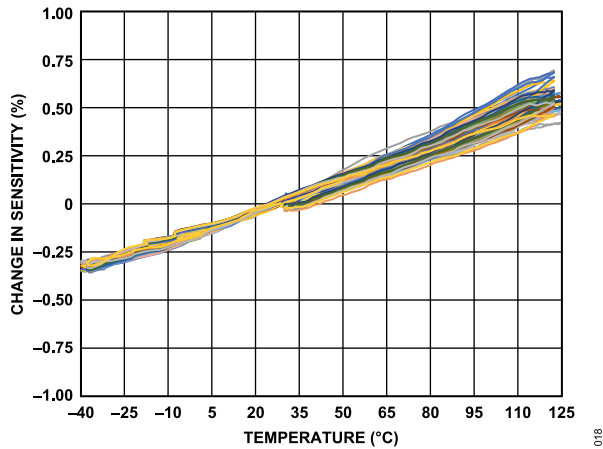

Figure 12. Y-Axis Change in Sensitivity Relative to 25°C vs. Temperature

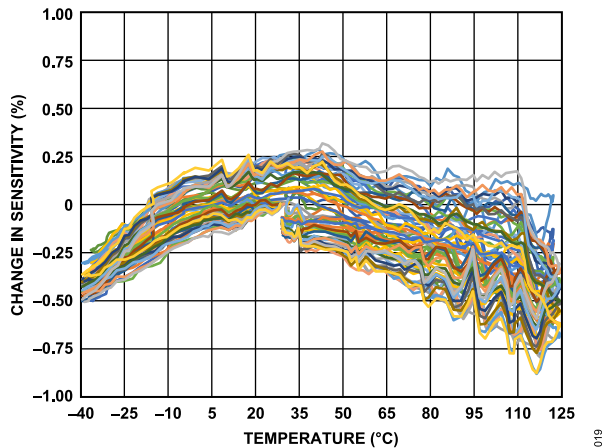

Figure 13. Z-Axis Change in Sensitivity Relative to 25°C vs. Temperature

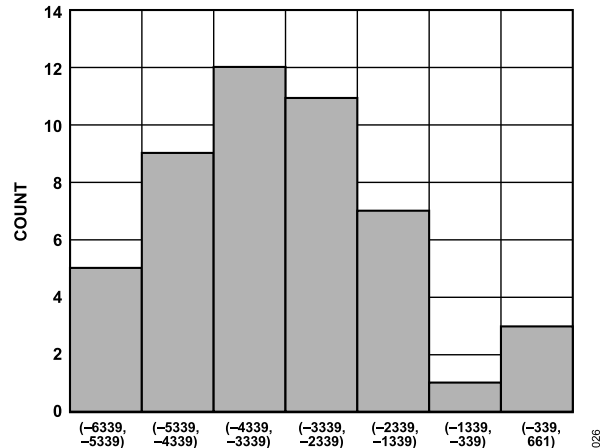

Figure 14. Zero g Offset Histogram at 25°C, X-Axis

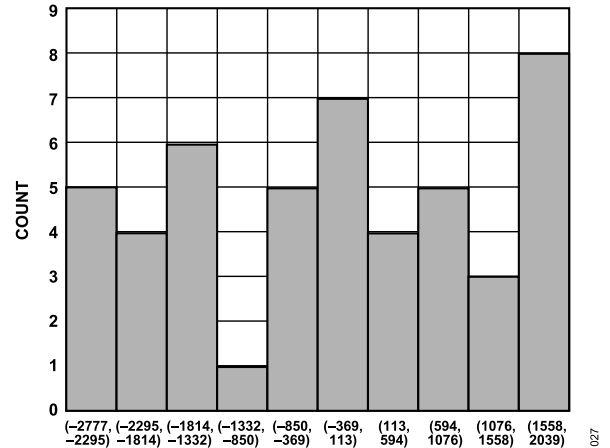

Figure 15. Zero g Offset Histogram at 25°C, Y-Axis

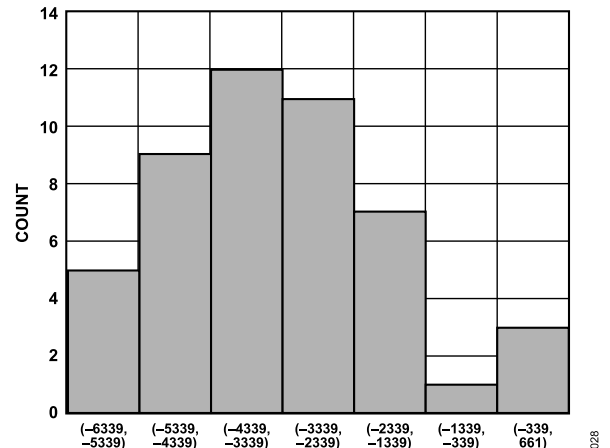

Figure 16. Zero g Offset Histogram at 25°C, Z-Axis

TYPICAL PERFORMANCE CHARACTERISTICS

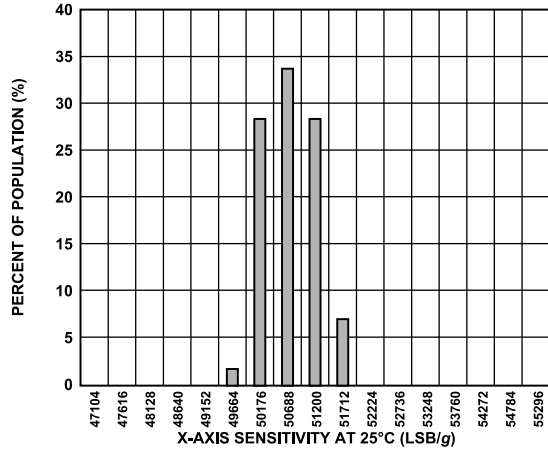

Figure 17. Sensitivity Histogram at 25°C, X-Axis

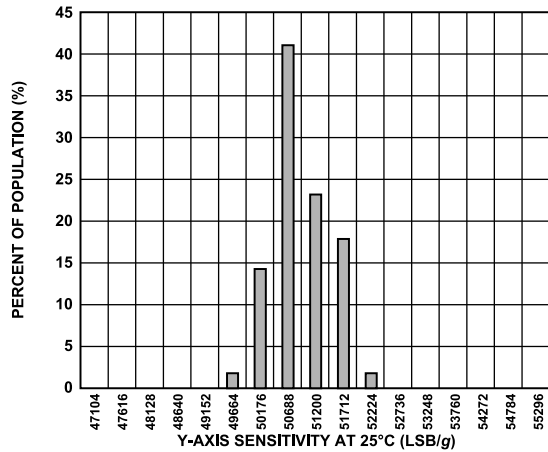

Figure 18. Sensitivity Histogram at 25°C, Y-Axis

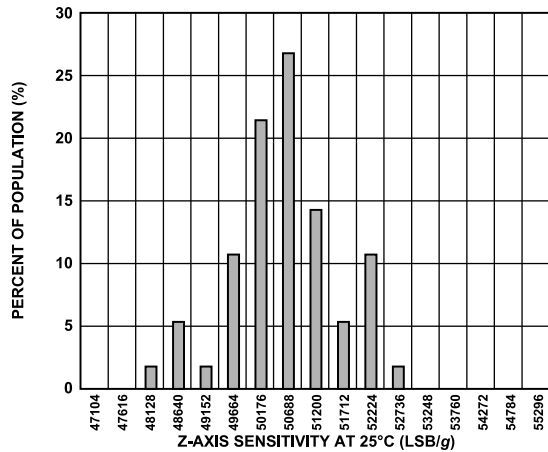

Figure 19. Sensitivity Histogram at 25°C, Z-Axis

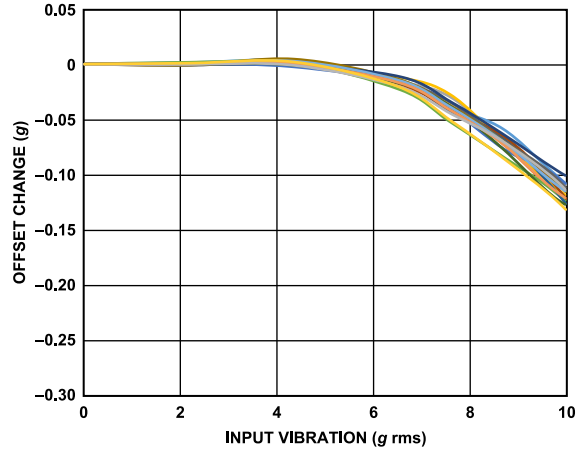

Figure 20. VRE, X-Axis Offset from +1 g, ±10 g Range, X-Axis Orientation = -1 g

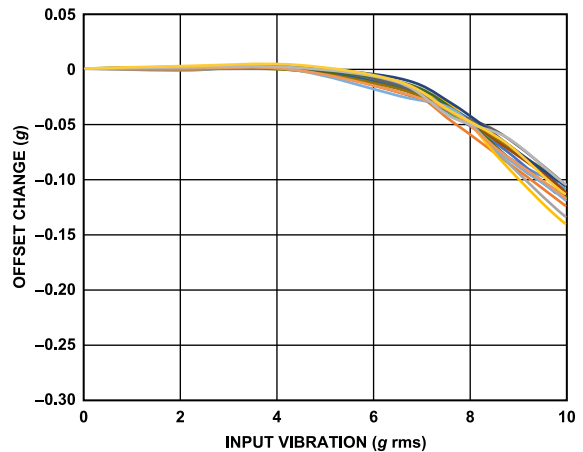

Figure 21. VRE, Y-Axis Offset from +1 g, ±10 g Range, Y-Axis Orientation = -1 g

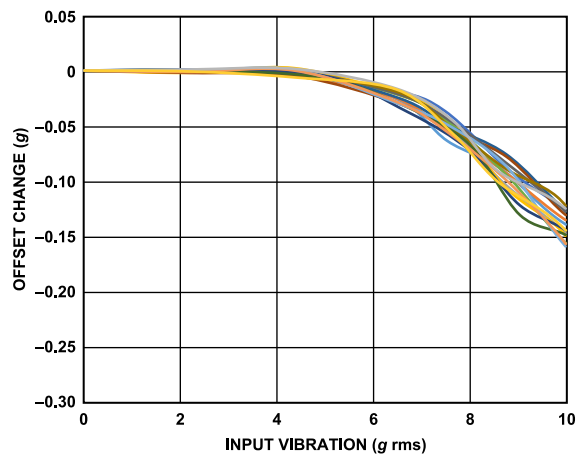

Figure 22. VRE, Z-Axis Offset from +1 g, ±10 g Range, Z-Axis Orientation = -1 g

TYPICAL PERFORMANCE CHARACTERISTICS

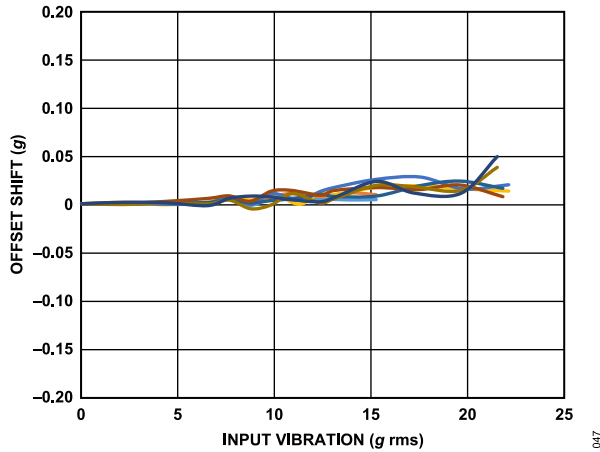

Figure 23. VRE, X-Axis Offset from +1 g, ±40 g Range, X-Axis Orientation = -1 g

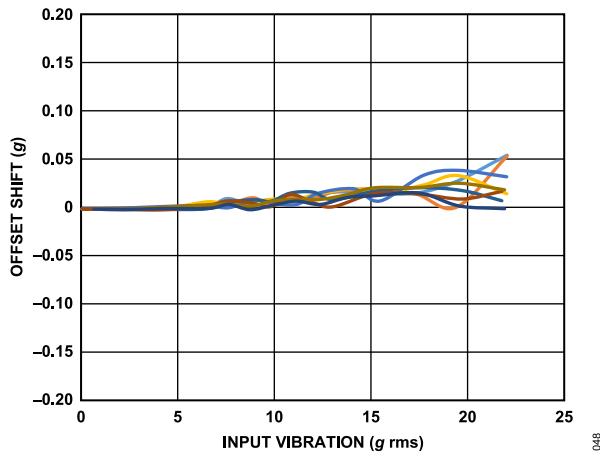

Figure 24. VRE, Y-Axis Offset from +1 g, ±40 g Range, Y-Axis Orientation = -1 g

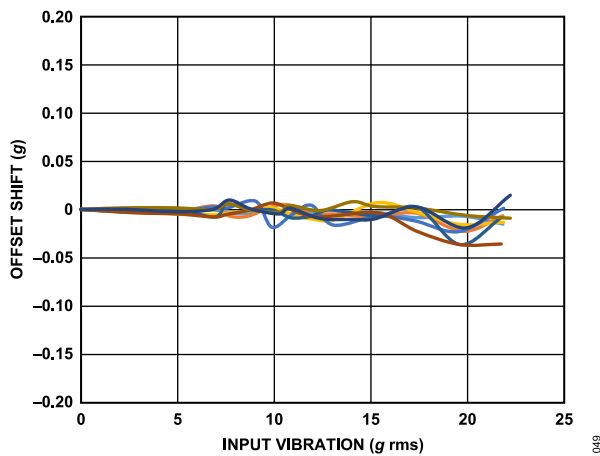

Figure 25. VRE, Z-Axis Offset from +1 g, ±40 g Range, Z-Axis Orientation = -1 g

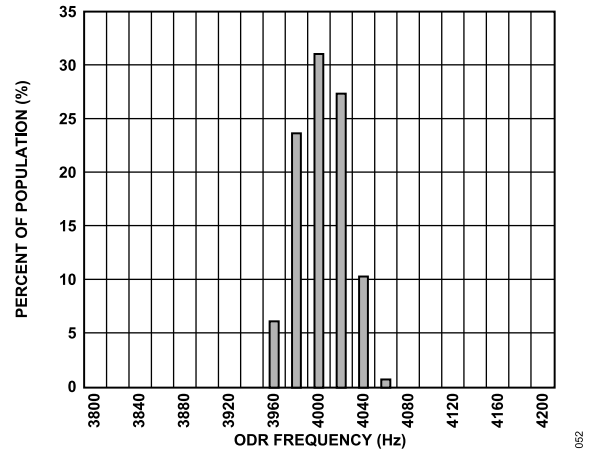

Figure 26. Internal ODR Frequency Histogram

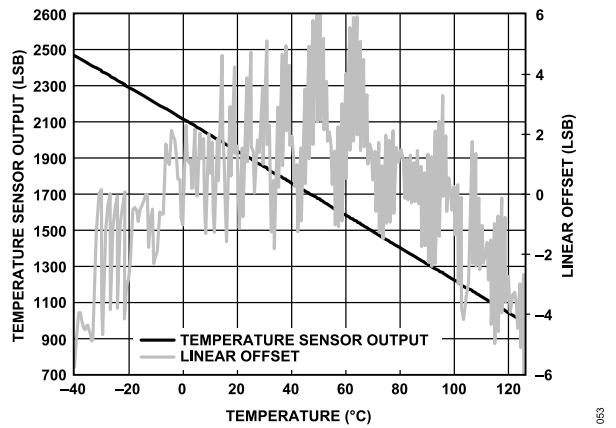

Figure 27. Temperature Sensor Output and Linearity Offset vs. Temperature

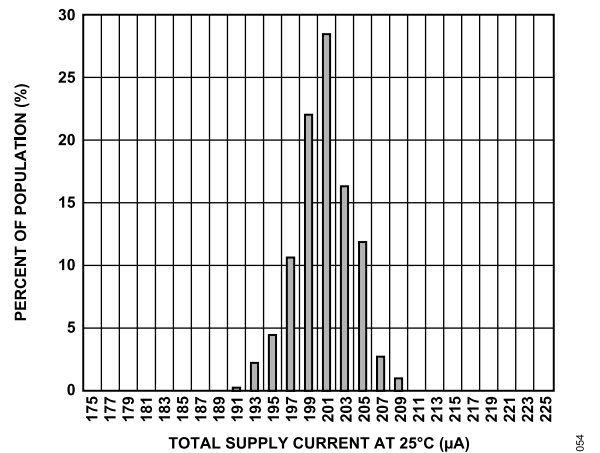

Figure 28. Total Supply Current at 25°C, 3.3 V

THEORY OF OPERATION

The ADXL359 is a complete 3-axis, ultralow noise and ultrastable offset MEMS accelerometer with outputs ratiometric to the analog 1.8 V supply, V_{1P8ANA} . The ADXL359 includes three high resolution ADCs that use the analog 1.8 V supply as a reference to provide digital outputs insensitive to the supply voltage. The ADXL359 is programmable for $\pm 10 g$, $\pm 20 g$, and $\pm 40 g$ full scale. The ADXL359 offers both SPI and I²C communications ports.

The micromachined, sensing elements are fully differential, comprising the lateral x-axis and y-axis sensors and the vertical, teeter totter z-axis sensors. The x-axis and y-axis sensors and the z-axis sensors go through separate signal paths that minimize offset drift and noise. The signal path is fully differential.

The ADXL359 includes antialias filters before and after the high resolution Σ - Δ ADC. User-selectable output data rates and filter corners are provided. The temperature sensor is digitized with a 12-bit successive approximation register (SAR) ADC.

APPLICATIONS INFORMATION

DIGITAL OUTPUT

The ADXL359 includes an internal configurable digital band-pass filter. Both the high-pass and low-pass poles of the filter are adjustable, as detailed in the [Filter Settings Register](#) section and [Table 42](#). At power-up, the default conditions for the filters are as follows:

- ▶ HPF = dc (off)
- ▶ LPF = 1000 Hz
- ▶ ODR = 4000 Hz

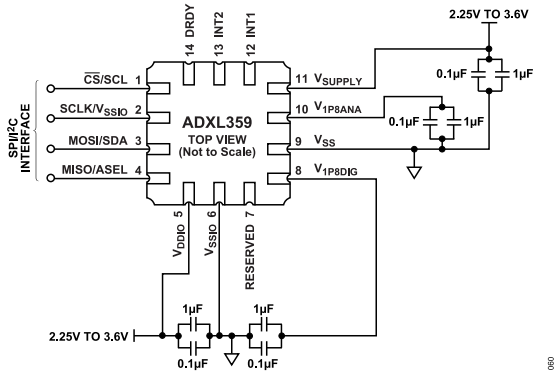

Figure 29. Application Circuit

AXES OF ACCELERATION SENSITIVITY

Figure 30 shows the axes of acceleration sensitivity. Note that the output voltage increases when accelerated along the sensitive axis.

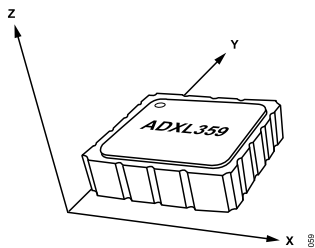

Figure 30. Axes of Acceleration Sensitivity

POWER SEQUENCING

There are two methods for applying power to the device. Typically, internal LDO regulators generate the 1.8 V power for the analog and digital supplies, V_{1P8ANA} and V_{1P8DIG} , respectively. Optionally, connecting V_{SUPPLY} to V_{SS} and driving V_{1P8ANA} and V_{1P8DIG} with an external supply can supply V_{1P8ANA} and V_{1P8DIG} .

When using the internal LDO regulators, connect V_{SUPPLY} to a voltage source between 2.25 V to 3.6 V. In this case, V_{DDIO} and V_{SUPPLY} can be powered in parallel. V_{SUPPLY} must not exceed the V_{DDIO} voltage by greater than 0.5 V. If necessary, V_{DDIO} can be powered before V_{SUPPLY} .

When disabling the internal LDO regulators and using an external 1.8 V supply to power V_{1P8ANA} and V_{1P8DIG} , tie V_{SUPPLY} to ground and set V_{1P8ANA} and V_{1P8DIG} to the same final voltage level. In the

case of bypassing the LDO regulators, the recommended power sequence is to apply power to V_{DDIO} , followed by V_{1P8DIG} approximately 10 μ s after, and then V_{1P8ANA} approximately 10 μ s later. If necessary, V_{1P8DIG} and V_{DDIO} can be powered from the same 1.8 V supply, which can also be tied to V_{1P8ANA} with proper isolation. In this case, proper decoupling and low frequency isolation are important to maintain the noise performance of the sensor.

POWER SUPPLY DESCRIPTION

The ADXL359 has four different power supply domains: V_{SUPPLY} , V_{1P8ANA} , V_{1P8DIG} , and V_{DDIO} . The internal analog and digital circuitry operates at 1.8 V nominal.

 V_{SUPPLY}

V_{SUPPLY} is 2.25 V to 3.6 V, which is the input range to the two LDO regulators that generate the nominal 1.8 V outputs for V_{1P8ANA} and V_{1P8DIG} . Connect V_{SUPPLY} to V_{SS} to disable the LDO regulators, which allows driving V_{1P8ANA} and V_{1P8DIG} from an external source.

 V_{1P8ANA}

All sensor and analog signal processing circuitry operates in this domain. The digital output ADXL359 includes ADCs that are ratio-metric to V_{1P8ANA} , thereby rendering offset and sensitivity insensitive to the value of V_{1P8ANA} . V_{1P8ANA} can be an input or an output as defined by the state of the V_{SUPPLY} voltage.

 V_{1P8DIG}

V_{1P8DIG} is the supply voltage for the internal logic circuitry. A separate LDO regulator decouples the digital supply noise from the analog signal path. V_{1P8ANA} can be an input or an output as defined by the state of the V_{SUPPLY} voltage. If driven externally, V_{1P8DIG} must be the same voltage as the V_{1P8ANA} voltage.

 V_{DDIO}

The V_{DDIO} value determines the logic high levels. For the digital outputs of the ADXL359, V_{DDIO} sets the logic high level for communications interface ports, as well as the interrupt and DRDY outputs.

The LDO regulators are operational when V_{SUPPLY} is between 2.25 V and 3.6 V. V_{1P8ANA} and V_{1P8DIG} are the regulator outputs in this mode. Alternatively, when tying V_{SUPPLY} to V_{SS} , V_{1P8ANA} and V_{1P8DIG} are supply voltage inputs with a 1.62 V to 1.98 V range.

OVERRANGE PROTECTION

To avoid electrostatic capture of the proof mass when the accelerometer is subject to input acceleration beyond its full-scale range, all sensor drive clocks turn off for 0.5 ms. In the $\pm 10 g$ range setting, the overrange protection activates for input signals beyond approximately $\pm 40 g$ ($\pm 25\%$), and for the $\pm 20 g$ and $\pm 40 g$ range settings, the threshold corresponds to about $\pm 80 g$ ($\pm 25\%$).

APPLICATIONS INFORMATION

When overrange protection occurs, the ADXL359 output floats toward zero, and the first in, first out (FIFO) buffer begins filling with this data.

SELF TEST

The ADXL359 incorporates a self test feature that effectively tests the mechanical and electronic system. Enabling self test stimulates the sensor electrostatically to produce an output corresponding to the test signal applied as well as the mechanical force exerted. Only the z-axis response is specified to validate the device functionality.

To perform a self test, set the ST1 bit in the SELF_TEST register (Register 0x2E) to invoke self test mode. For the initial self test value, with the ST2 bit set to Logic 0 (low), record the output. Then, by setting the ST2 bit to Logic 1 (high), record the output to produce the second self test value. With the ST2 and ST1 bits set to Logic 1, the ADXL359 applies an electrostatic force to the mechanical sensor and induces a change in output in response to the force. The self test delta (or response) is the difference in output of the z-axis when ST2 is high vs. ST2 is low. After the self test measurement is complete, clear both register bits low to resume normal operation.

The self test feature rejects externally applied acceleration and only responds to the self test force, which allows an accurate measurement of the self test, even in the presence of external mechanical noise.

FILTER

The ADXL359 uses an analog, low-pass, antialiasing filter to reduce out of band noise and to limit bandwidth at the output of the sensor. The ADXL359 provides further digital filtering options to maintain excellent noise performance at various ODRs.

The internal analog, low-pass antialiasing filter in the ADXL359 provides a fixed bandwidth of approximately 1.5 kHz, the frequency at which the output response is attenuated by approximately 50%. The shape of the filter response in the frequency domain is that of a sinc3 filter.

The ADXL359 provides an internal 20-bit, Σ - Δ ADC to digitize the filtered analog signal. Additional digital filtering (beyond the analog, low-pass, antialiasing filter) consists of a low-pass digital decimation filter and a bypassable high-pass filter that supports output data rates between 4 kHz and 3.906 Hz. The decimation filter consists of two stages. The first stage is fixed decimation with a 4 kHz ODR with a LPF cutoff (50% reduction in output response) at 1 kHz. A variable second stage decimation filter is used for the 2 kHz ODR and below (it is bypassed for 4 kHz ODR). [Figure 31](#) shows the LPF response with a 1 kHz corner (4 kHz ODR) for the ADXL359. Note that [Figure 31](#) does not include the fixed frequency analog, low-pass, antialiasing filter with a fixed bandwidth of approximately 1.5 kHz.

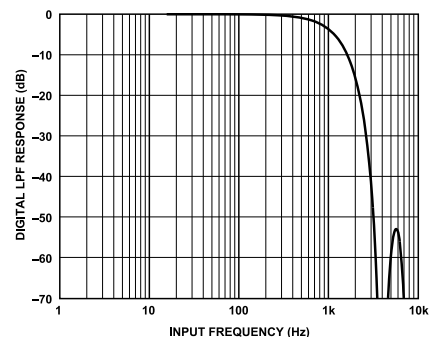

Figure 31. Digital LPF Response for 4 kHz ODR

The ADXL359 pass band of the signal path relates to the combined filter responses, including the analog filter previously described, and the digital decimation filter/ODR setting. [Table 8](#) shows the delay associated with the decimation filter for each setting and provides the attenuation at the ODR/4 corner.

The ADXL359 also includes an optional digital high-pass filter with a programmable corner frequency. By default, the high-pass filter is disabled. The high-pass corner frequency, where the output is attenuated by 50%, is related to the ODR, and the HPF_CORNER setting in the filter register (Register 0x28, Bits[6:4]). [Table 9](#) shows the HPF_CORNER response. [Figure 32](#) and [Figure 33](#) show the simulated high-pass filter response and delay for a 10 Hz cutoff.

The ADXL359 also includes an interpolation filter, after the decimation filters, that produces oversampled and upconverted data and provides an external synchronization option. See the [Data Synchronization](#) section for more details. [Table 10](#) shows the delay and attenuation relative to the programmed ODR.

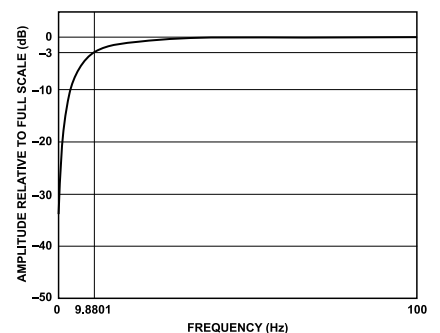

Figure 32. HPF Pass-Band Response for a 4 kHz ODR and an HPF_CORNER Setting of 001 (Register 0x28, Bits[6:4])

Group delay is the digital filter delay from the input to the ADC until data is available at the interface.

This delay is the largest component of the total delay from sensor to serial interface.

APPLICATIONS INFORMATION

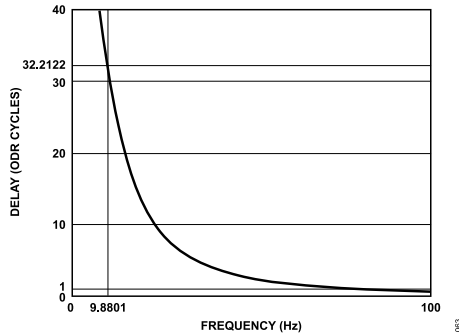

Figure 33. HPF Delay Response for a 4 kHz ODR and an HPF_CORNER Setting of 001 (Register 0x28, Bits[6:4])

Table 8. Digital Filter Group Delay and Profile

Programmed ODR (Hz)	Delay		Attenuation	
	ODR (Cycles)	Time (ms)	Decimator at ODR/4 (dB)	Full Path at ODR/4 (dB)
4000	2.52	0.63	-3.44	-3.63
4000/2 = 2000	2.00	1.00	-2.21	-2.26
4000/4 = 1000	1.78	1.78	-1.92	-1.93
4000/8 = 500	1.63	3.26	-1.83	-1.83
4000/16 = 250	1.57	6.27	-1.83	-1.83
4000/32 = 125	1.54	12.34	-1.83	-1.83
4000/64 = 62.5	1.51	24.18	-1.83	-1.83
4000/128 ~ 31	1.49	47.59	-1.83	-1.83
4000/256 ~ 16	1.50	96.25	-1.83	-1.83
4000/512 ~ 8	1.50	189.58	-1.83	-1.83
4000/1024 ~ 4	1.50	384.31	-1.83	-1.83

Table 9. Digital High-Pass Filter Response

HPF_CORNER Register Setting (Register 0x28, Bits[6:4])	HPF_CORNER Frequency, -3 dB Point Relative to ODR Setting	-3 dB at 4 kHz ODR (Hz)
000	Not applicable, no high-pass filter enabled	Off
001	$24.7 \times 10^{-4} \times \text{ODR}$	9.88
010	$6.2084 \times 10^{-4} \times \text{ODR}$	2.48
011	$1.5545 \times 10^{-4} \times \text{ODR}$	0.62
100	$0.3862 \times 10^{-4} \times \text{ODR}$	0.1545
101	$0.0954 \times 10^{-4} \times \text{ODR}$	0.03816
110	$0.0238 \times 10^{-4} \times \text{ODR}$	0.00952

Table 10. Combined Digital Interpolation Filter and Decimation Filter Response

Interpolator Data Rate Resolution Relative to $64 \times \text{ODR}$ (Hz)	Combined Interpolator/Decimator Delay (ODR Cycles)	Combined Interpolator/Decimator Delay (ms)	Combined Interpolator/Decimator Output Attenuation at ODR/4 (dB)
$64 \times 4000 = 256000$	3.51661	0.88	-6.18
$64 \times 2000 = 128000$	3.0126	1.51	-4.93
$64 \times 1000 = 64000$	2.752	2.75	-4.66
$64 \times 500 = 32000$	2.6346	5.27	-4.58
$64 \times 250 = 16000$	2.5773	10.31	-4.55
$64 \times 125 = 8000$	2.5473	20.38	-4.55
$64 \times 62.5 = 4000$	2.53257	40.52	-4.55
$64 \times 31.25 = 2000$	2.52452	80.78	-4.55
$64 \times 15.625 = 1000$	2.52045	161.31	-4.55

APPLICATIONS INFORMATION**Table 10. Combined Digital Interpolation Filter and Decimation Filter Response**

Interpolator Data Rate Resolution Relative to $64 \times \text{ODR}$ (Hz)	Combined Interpolator/ Decimator Delay (ODR Cycles)	Combined Interpolator/ Decimator Delay (ms)	Combined Interpolator/Decimator Output Attenuation at ODR/4 (dB)
$64 \times 7.8125 = 500$	2.5194	322.48	-4.55
$64 \times 3.90625 = 250$	2.51714	644.39	-4.55

SERIAL COMMUNICATIONS

The 4-wire serial interface communicates in either the SPI or I²C protocol. It affectively autodetects the format being used, requiring no configuration control to select the format.

SPI PROTOCOL

Wire the ADXL359 for SPI communication as shown in the connection diagram in Figure 34. The SPI protocol timing is shown in Figure 35 to Figure 38. The timing scheme follows the clock polarity (CPOL) = 0 and clock phase (CPHA) = 0. The SPI clock speed ranges from 100 kHz to 10 MHz.

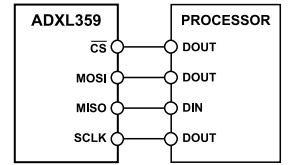

Figure 34. 4-Wire SPI Connection

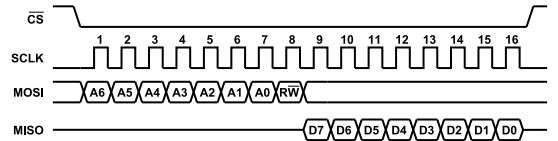

Figure 35. SPI Timing Diagram—Single-Byte Read

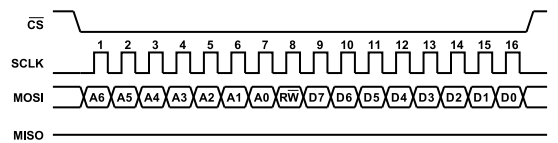

Figure 36. SPI Timing Diagram—Single-Byte Write

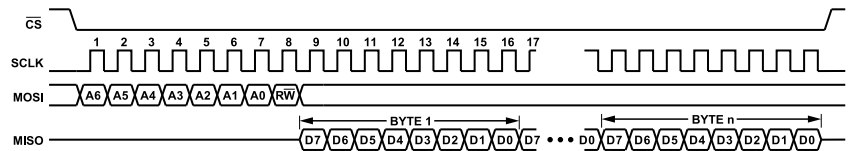

Figure 37. SPI Timing Diagram—MultiByte Read

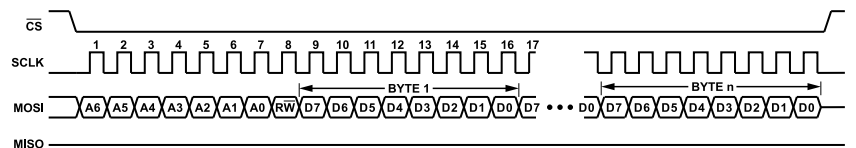

Figure 38. SPI Timing Diagram—MultiByte Write

SERIAL COMMUNICATIONS

I²C PROTOCOL

The ADXL359 supports point to point I²C communication. However, when sharing an SDA bus, the ADXL359 may prevent communication with other devices on that bus. If at any point, even when the ADXL359 is not being addressed, the 0x3A and 0x3B bytes (when the ADXL359 device ID is set to 0x1D) or the 0xA6 and 0xA7 bytes (when the ADXL359 device ID is set to 0x53) are transmitted on the SDA bus, the ADXL359 responds with an acknowledge bit and pulls the SDA line down. For example, this response can occur when reading or writing the data bytes (0x3A and 0x3B or 0xA6 and 0xA7) to another sensor on the bus. When the ADXL359 pulls the SDA line down, communication with other devices on the bus may be interrupted. To resolve this, the ADXL359 must be connected to a separate SDA bus, or the SCL pin must be switched high when communication with the ADXL359 is not desired (it is normally grounded).

The ADXL359 supports standard (100 kHz), fast (up to 1 MHz) and high speed (up to 3.4 MHz) data transfer modes when the bus parameters in Table 3 are met. There is no minimum SCL frequency, with the exception that, when reading data, the clock must be fast enough to read an entire sample set before new data overwrites it. Single- or multiple-byte reads and /writes are supported. With the ASEL pin low, the I²C address for the device is 0x1D, and an alternate I²C address of 0x53 can be chosen by pulling the ASEL pin high.

There are no internal pull-up or pull-down resistors for any unused pins; therefore, there is no known state or default state for the pins if left floating or unconnected. It is required that SCLK/V_{SSIO} be connected to ground when communicating to the ADXL359 using I²C.

Due to communication speed limitations, the maximum output data rate when using the 400 kHz I²C mode is 800 Hz, and it scales linearly with a change in the I²C communication speed. For example, using I²C at 100 kHz limits the maximum ODR to 200 Hz. Operation at an ODR more than the recommended maximum may result in an undesirable effect on the acceleration data, including missing samples or additional noise.

Figure 39 to Figure 41 detail the I²C protocol timing. The I²C interface can be used on most buses operating in I²C standard

mode (100 kHz), fast mode (400 kHz), fast mode plus (1 MHz), and high speed mode (3.4 MHz). The ADXL359 I²C device ID is as follows:

- ▶ ASEL (pin) = 0, device address = 0x1D
- ▶ ASEL (pin) = 1, device address = 0x53

If other devices are connected to the same I²C bus, the nominal operating voltage level of these other devices cannot exceed V_{DDIO} by more than 0.3 V. External pull-up resistors, R_p, are necessary for proper I²C operation.

READING ACCELERATION OR TEMPERATURE DATA FROM THE INTERFACE

Acceleration data is left justified and has a register address order of the most significant data to the least significant data, which allows the user to use multibyte transfers and to take only as much data as required—either 8 bits, 16 bits, or 20 bits, plus the marker. Temperature data is 12 bits unsigned, right justified.

The ADXL359 temperature value is split over two bytes but is not double buffered, meaning the value can update between readings of the two registers. The data in XDATA, YDATA, and ZDATA registers is always the most recent available. It is not guaranteed that XDATA, YDATA, and ZDATA form a set corresponding to one sample point in time. The routine used to retrieve the data from the device controls this data set continuity. If data transfers are initiated when the DATA_RDY bit goes high and completes in a time approximately equal to 1/ODR, XDATA, YDATA, and ZDATA apply to the same data set.

For multibyte read or write transactions through either serial interface, the internal register address auto-increments. When the top of the register address range (0x3FF) is reached, the auto-increment stops and does not wrap back to Hexadecimal Address 0x00.

The address auto-increment function disables when the FIFO address is used so that data can be read continuously from the FIFO as a multibyte transaction. In cases where the starting address of a multibyte transaction is less than the FIFO address, the address auto-increments until reaching the FIFO address, and then stops at the FIFO address.

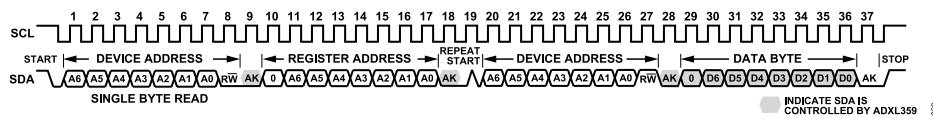

Figure 39. I²C Timing Diagram—Single-Byte Read



Figure 40. I²C Timing Diagram—Single-Byte Write

SERIAL COMMUNICATIONS

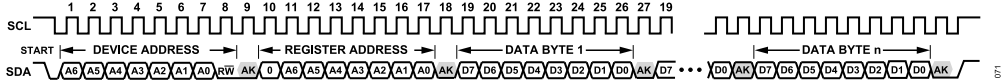

Figure 41. I²C Timing Diagram—MultiByte Write

FIFO

The FIFO operates in stream mode; that is, when the FIFO overruns new data overwrites the oldest data in the FIFO. A read from the FIFO address guarantees that the three bytes associated with the acceleration measurement on an axis all pertain to the same measurement. If the FIFO never overflows, the data is always taken out in sets (multiples of three data points).

There are 96 21-bit locations in the FIFO. Each location contains 20 bits of data and a marker bit for the x-axis data. A single-byte read from the FIFO address pops one location from the FIFO. A multibyte read to the FIFO location pops the FIFO on the read of the first byte and every third byte read thereafter.

logic inserts the two virtual bits (0b00) between the data bits and the empty indicator bit. Bit 1 indicates that an attempt was made to read an empty FIFO, and that the data is not valid acceleration data. Bit 0 is a marker bit to identify the x-axis, which allows a user to verify that the FIFO data was correctly read. An acceleration data point for a given axis occupies one FIFO location. The read pointer, RD_PTR, points to the oldest stored data that was not read already from the interface (see Figure 42). There are no physical x-acceleration, y-acceleration, or z-acceleration data registers. This data also comes directly from the most recent data set in the FIFO, which is pointed to by the z pointer, Z_PTR (see Figure 42).

Figure 42 shows the organization of the data in the FIFO. The acceleration data is twos complement, 20-bit data. The FIFO control

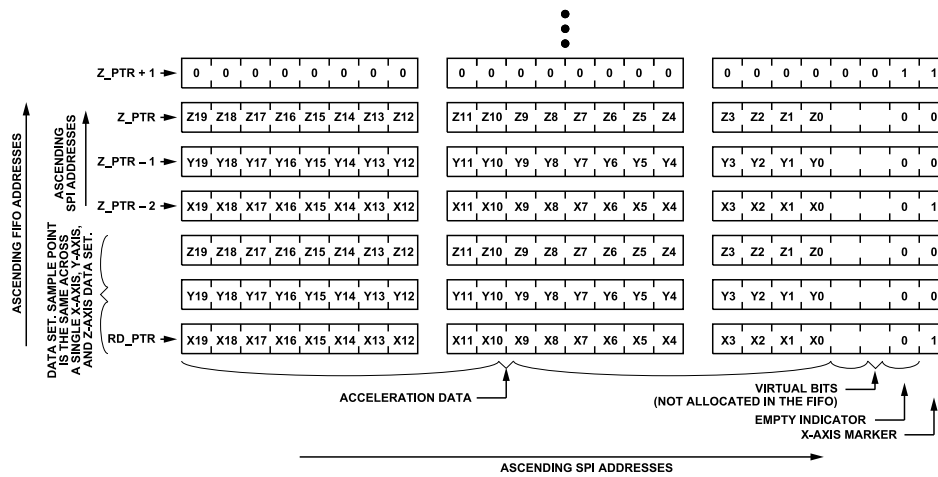

Figure 42. FIFO Data Organization

INTERRUPTS

The status register (Register 0x04) contains five individual bits, four of which can be mapped to either the INT1 pin, the INT2 pin, or both. The polarity of the interrupt, active high or active low, is also selectable via the INT_POL bit in the range (Register 0x2C) register. In general, the status register clears when read, but this is not the case if the condition that caused the interrupt persists after the read of the register. The definition of persist varies slightly in each case, but it is described in the [DATA_RDY](#), [DRDY Pin](#), [FIFO_FULL](#), [FIFO_OVR](#), and [Activity](#) sections.

The DRDY pin is similar to the interrupt pins (INTx) but clears very differently, which is also described.

DATA_RDY

The DATA_RDY bit (Register 0x04, Bit 0) is set when new acceleration data is available to the interface. It clears on a read of the status register. It is not set again until acceleration data that is newer than the status register read is available.

Special logic on the clear of the DATA_RDY bit covers the corner case where new data arrives during the read of the status register. In this case, the data ready condition may be missed completely. This logic results in a delay of the clearing of the DATA_RDY bit of up to four 512 kHz cycles.

DRDY PIN

The DRDY pin (Pin 14) is not a status register bit. This pin instead behaves similar to an unmaskable interrupt. DRDY is set when new acceleration data is available to the interface. This pin clears on a read of the FIFO, on a read of the XDATA, YDATA, or ZDATA register, or by an autoclear function that occurs approximately halfway between output acceleration data sets.

DRDY is always active high. The INT_POL bit does not affect DRDY. In external sync modes (EXT_SYNC = 01, EXT_SYNC = 10), the first few DRDY pulses after initial synchronization can be lost or corrupted. The length of this potential corruption is less than the group delay.

FIFO_FULL

The FIFO_FULL bit (Register 0x04, Bit 1) is set when the entries in the FIFO are equal to the setting of the FIFO_SAMPLES bits. The bit clears as follows:

- ▶ If the number of entries in the FIFO is less than the number of samples indicated by the FIFO_SAMPLES bits, which is only the case if sufficient data is read from the FIFO.
- ▶ On a read of the status register, but only when the entries in the FIFO are less than the FIFO_SAMPLES bits.

FIFO_OVR

The FIFO_OVR bit (Register 0x04, Bit 2) is set when the FIFO is so far overrange that data is lost. The specified size of the FIFO is 96 locations. The FIFO_OVR is set only when there is an attempt to write past this 96 location limit.

A read of the status register clears FIFO_OVR. It is not set again until data is lost subsequent to this data register read.

ACTIVITY

The activity bit (Register 0x04, Bit 3) is set when the measured acceleration on any axis is more than the ACT_THRESH bits, Bits[15:0], for ACT_COUNT, Bits[7:0], consecutive measurements. An overthreshold condition can shift from one axis to another on successive measurements and is still counted toward the consecutive ACT_COUNT count.

A read of the status register clears the activity bit, but it sets again at the end of the next measurement if the activity bit conditions are still satisfied.

NVM_BUSY

The NVM_BUSY bit (Register 0x04, Bit 1) indicates that the nonvolatile memory (NVM) controller is busy, and it cannot be accessed to read, write, or generate an interrupt.

A status register read that occurs after the NVM controller is no longer busy clears NVM_BUSY.

EXTERNAL SYNCHRONIZATION AND INTERPOLATION

There are three possible synchronization options for the ADXL359, shown in [Figure 43](#) to [Figure 45](#). For clarity, the clock frequencies and delays are drawn to scale. The labels in [Figure 43](#) to [Figure 45](#) are defined as follows:

- ▶ Internal ODR is the alignment of the decimated output data based on the internal clock.
- ▶ ADC CLK shows the internal controller clock rate
- ▶ DRDY is an output indicator signaling a sample is ready.

The three modes are as follows:

- ▶ No external synchronization (internal clocks used)
- ▶ Synchronization with interpolation filter enabled.
- ▶ Sync with an external sync and clock signals, no interpolation filter

EXT_SYNC = 00—No External Sync or Interpolation

For this case, an internal clock that serves as the synchronization controller generates the data. No external signals are required, and this is used commonly when the external processor retrieves data from the device asynchronously and absolute synchronization to an external source is not required. Use Register 0x28 to program the ODR.

The device outputs a DRDY (active high) to signal that a new sample is available, and data is retrieved from the real-time registers or the FIFO. The group delay is based on the decimation setting as shown in [Table 8](#).

INTERRUPTS

EXT_SYNC = 10—External Sync with Interpolation

In this case, the internal clock generates data; however, an interpolation filter provides additional time resolution of 64 times the programmed ODR. Synchronization using interpolation filters and an external ODR clock is commonly used when the external processor can provide a synchronization signal (which is asynchronous to the internal clock) at the desired ODR. Synchronization with the interpolation filter enabled (EXT_SYNC = 10) allows the non-synchronous external clock to output data most closely associated with the external clock rising edge. The interpolation filter provides a frequency resolution related to ODR (see [Table 10](#)).

The advantage of this mode is that data is available at a user defined sample rate and is asynchronous to the internal oscillator. The disadvantage of this mode is that the group delay is increased, with increased attenuation at the band edge. Additionally, because there is a limit to the time resolution, there is some distortion related to the mismatch of the external sync relative to the internal oscillator. This mismatch degrades spectral performance. The group delay is based on the decimation setting and interpolation setting (see [Table 10](#)). [Table 11](#) shows the delay between the SYNC signal (input) to DRDY (output).

Table 11. EXT_SYNC = 10, DRDY Delay

ODR_LPF	SYNC to DRDY Delay (Oscillator Cycles)
0x0	8
0x1	10
0x2	14
0x3	22
0x4	38
0x5	70
0x6	134
0x7	262
0x8	1031
0x9	2054
0x10	4102

Table 12. Multiplexing of INT2 and DRDY

Register or Bit Fields			Pins		
EXT_CLK	EXT_SYNC, Bits[1:0]	INT_MAP, Bits[7:4]	INT2 (Pin 13)	DRDY (Pin 14)	Comments
0	00	0000	Low	DRDY	Synchronization is to the internal clocks, and there is no external clock synchronization.
0	00	Not 0000	INT2	DRDY	
1	00	0000	EXT_CLK	DRDY	
1	00	Not 0000 ¹	EXT_CLK	DRDY	
0	01	0000	DRDY ²	SYNC	These options reset the digital filters on every synchronization pulse and are not recommended.
0	01 ³	Not 0000	INT2	SYNC	
1	01 ³	0000	EXT_CLK	SYNC	External synchronization, no interpolation filter, and DRDY (active high) signals that data is ready. Data represents a sample point group delay earlier in time.
1	01 ³	Not 0000 ¹	EXT_CLK	SYNC	
0	10	0000	DRDY ²	SYNC	External synchronization, interpolation filter, and DRDY (active high) signals that data is ready. Data sample group delay earlier in time.
0	10 ³	Not 0000	INT2	SYNC	

EXT_SYNC = 01—External Sync and External Clock, No Interpolation Filter

In this case, an external source provides an external clock at a frequency of $4 \times 64 \times \text{ODR}$. The external clock becomes the controller clock source for the device. In addition, an external synchronization signal is needed to align the decimation filter output to a specific clock edge, which provides full external synchronization and is commonly used when a fixed external clock captures and processes data, and asynchronous clocks are not allowed. When using multiple sensors, synchronization with an external controller clock is beneficial and requires time alignment.

When configured for EXT_SYNC = 01 with an ODR of 4 kHz, the user must supply an external clock at 1.024 MHz ($64 \times 4 \times 4$ kHz) on the INT2 pin (Pin 13), and an external synchronization on DRDY pin (Pin 14), as shown in [Table 12](#).

Special restrictions when using this mode include the following:

- ▶ An external clock (EXT_CLK) must be provided as well as an external sync.
- ▶ The frequency of EXT_CLK must be exactly $4 \times 64 \times \text{ODR}$.
- ▶ The width of synchronization must be a minimum of four EXT_CLK periods.
- ▶ The phase of synchronization must meet an approximate 25 ns setup time to the EXT_CLK rising edge.

When using the EXT_SYNC mode and without providing synchronization, the device runs on its own synchronization. Similarly, after synchronization, the device continues to run synchronized to the last synchronization pulse it received, which means that EXT_SYNC = 01 mode can be used with only a single synchronization pulse.

The interpolation filter provides a frequency resolution related to the ODR (see [Table 10](#)). In this case, the data provided corresponds to the external signal, which can be greater than the set ODR, but the output pass band remains the same it was prior to the interpolation filter.

INTERRUPTS

Table 12. Multiplexing of INT2 and DRDY

EXT_CLK	Register or Bit Fields		Pins		Comments
	EXT_SYNC, Bits[1:0]	INT_MAP, Bits[7:4]	INT2 (Pin 13)	DRDY (Pin 14)	
1	10 ³	0000	EXT_CLK	SYNC	
1	10 ³	Not 0000	EXT_CLK	SYNC	

- ¹ No INT2, even though it is enabled.
- ² DRDY routing through the INT_MAP register takes precedence over the default, per Table 12.
- ³ No DRDY.

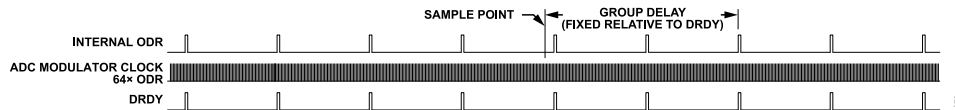

Figure 43. External Synchronization Option—EXT_SYNC = 00, Internal Sync

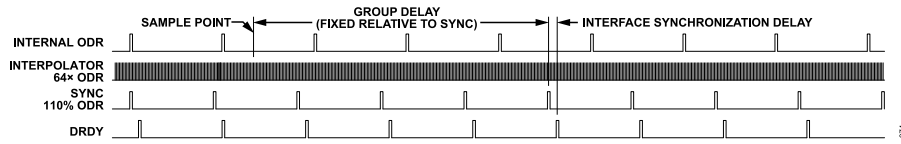

Figure 44. External Synchronization Option—EXT_SYNC = 10, External Sync, External Clock, Interpolation Filter

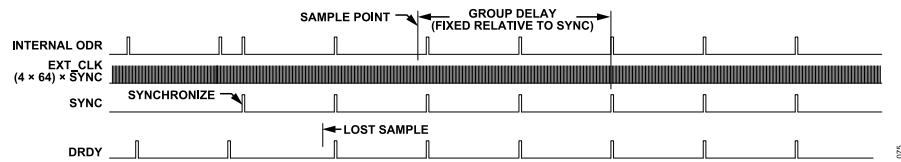

Figure 45. External Synchronization Option—EXT_SYNC = 01, External Sync, No Interpolation Filter

REGISTER MAP

Note that while configuring the ADXL359 in an application, all configuration registers must be programmed before enabling measurement mode in the POWER_CTL register. When the ADXL359 is in measurement mode, only the following configurations can

change: the HPF_CORNER bits in the filter register, the INT_MAP register, the ST1 and ST2 bits in the SELF_TEST register, and the reset register.

Table 13. Register Map

Hex. Addr.	Register Name	Bit 7	Bit 6	Bit 5	Bit 4	Bit 3	Bit 2	Bit 1	Bit 0	Reset	R/W	
0x00	DEVID_AD	DEVID_AD								0xAD	R	
0x01	DEVID_MST	DEVID_MST								0x1D	R	
0x02	PARTID	PARTID								0xE9	R	
0x03	REVID	REVID								0x01	R	
0x04	Status	Reserved			NVM_BUSY	Activity	FIFO_OVR	FIFO_FULL	DATA_RDY	0x00	R	
0x05	FIFO_ENTRIES	Reserved	FIFO_ENTRIES								0x00	R
0x06	TEMP2	Reserved				Temperature, Bits[11:8]				0x00	R	
0x07	TEMP1	Temperature, Bits[7:0]								0x00	R	
0x08	XDATA3	XDATA, Bits[19:12]								0x00	R	
0x09	XDATA2	XDATA, Bits[11:4]								0x00	R	
0x0A	XDATA1	XDATA, Bits[3:0]				Reserved				0x00	R	
0x0B	YDATA3	YDATA, Bits[19:12]								0x00	R	
0x0C	YDATA2	YDATA, Bits[11:4]								0x00	R	
0x0D	YDATA1	YDATA, Bits[3:0]				Reserved				0x00	R	
0x0E	ZDATA3	ZDATA, Bits[19:12]								0x00	R	
0x0F	ZDATA2	ZDATA, Bits[11:4]								0x00	R	
0x10	ZDATA1	ZDATA, Bits[3:0]				Reserved				0x00	R	
0x11	FIFO_DATA	FIFO_DATA								0x00	R	
0x1E	OFFSET_X_H	OFFSET_X, Bits[15:8]								0x00	R/W	
0x1F	OFFSET_X_L	OFFSET_X, Bits[7:0]								0x00	R/W	
0x20	OFFSET_Y_H	OFFSET_Y, Bits[15:8]								0x00	R/W	
0x21	OFFSET_Y_L	OFFSET_Y, Bits[7:0]								0x00	R/W	
0x22	OFFSET_Z_H	OFFSET_Z, Bits[15:8]								0x00	R/W	
0x23	OFFSET_Z_L	OFFSET_Z, Bits[7:0]								0x00	R/W	
0x24	ACT_EN	Reserved				ACT_Z	ACT_Y	ACT_X	0x00	R/W		
0x25	ACT_THRESH_H	ACT_THRESH, Bits[15:8]								0x00	R/W	
0x26	ACT_THRESH_L	ACT_THRESH, Bits[7:0]								0x00	R/W	
0x27	ACT_COUNT	ACT_COUNT								0x01	R/W	
0x28	Filter	Reserved	HPF_CORNER				ODR_LPF				0x00	R/W
0x29	FIFO_SAMPLES	Reserved	FIFO_SAMPLES								0x60	R/W
0x2A	INT_MAP	ACT_EN2	OVR_EN2	FULL_EN2	RDY_EN2	ACT_EN1	OVR_EN1	FULL_EN1	RDY_EN1	0x00	R/W	
0x2B	Sync	Reserved					EXT_CLK	EXT_SYNC			0x00	R/W
0x2C	Range	I2C_HS	INT_POL	Reserved				Range			0x81	R/W
0x2D	POWER_CTL	Reserved					DRDY_OFF	TEMP_OFF	Standby		0x01	R/W
0x2E	SELF_TEST	Reserved						ST2	ST1	0x00	R/W	
0x2F	Reset	Reset								0x00	W	

REGISTER DEFINITIONS

This section describes the functions of the ADXL359 registers. The ADXL359 powers up with the default register values, as shown in the reset column of [Table 13](#).

ANALOG DEVICES ID REGISTER

This register contains the Analog Devices ID, 0xAD.

Address: 0x00, Reset: 0xAD, Name: DEVID_AD

Table 14. Bit Descriptions for DEVID_AD

Bits	Bit Name	Settings	Description	Reset	Access
[7:0]	DEVID_AD		Analog Devices ID	0xAD	R

ANALOG DEVICES MEMS ID REGISTER

This register contains the Analog Devices MEMS ID, 0x1D.

Address: 0x01, Reset: 0x1D, Name: DEVID_MST

Table 15. Bit Descriptions for DEVID_MST

Bits	Bit Name	Settings	Description	Reset	Access
[7:0]	DEVID_MST		Analog Devices MEMS ID	0x1D	R

DEVICE ID REGISTER

This register contains the device ID, 0xE9 (351 octal).

Address: 0x02, Reset: 0xE9, Name: PARTID

Table 16. Bit Descriptions for PARTID

Bits	Bit Name	Settings	Description	Reset	Access
[7:0]	PARTID		Device ID (351 octal)	0xE9	R

PRODUCT REVISION ID REGISTER

This register contains the product revision ID, beginning with 0x00 and incrementing for each subsequent revision.

Address: 0x03, Reset: 0x01, Name: REVID

Table 17. Bit Descriptions for REVID

Bits	Bit Name	Settings	Description	Reset	Access
[7:0]	REVID		Mask revision	0x01	R

STATUS REGISTER

This register includes bits that describe the various conditions of the ADXL359.

Address: 0x04, Reset: 0x00, Name: Status

Table 18. Bit Descriptions for Status

Bits	Bit Name	Settings	Description	Reset	Access
[7:5]	Reserved		Reserved.	0x0	R
4	NVM_BUSY		NVM controller is busy with a refresh, programming, or a built in self test (BIST).	0x0	R
3	Activity		Activity, as defined in the ACT_THRESH_x and ACT_COUNT registers, is detected.	0x0	R
2	FIFO_OVR		FIFO has overrun, and the oldest data is lost.	0x0	R

REGISTER DEFINITIONS

Table 18. Bit Descriptions for Status

Bits	Bit Name	Settings	Description	Reset	Access
1	FIFO_FULL		FIFO watermark is reached.	0x0	R
0	DATA_RDY		A complete x-axis, y-axis, and z-axis measurement was made and results can be read.	0x0	R

FIFO ENTRIES REGISTER

This register indicates the number of valid data samples present in the FIFO buffer. This number ranges from 0 to 96.

Address: 0x05, Reset: 0x00, Name: FIFO_ENTRIES

Table 19. Bit Descriptions for FIFO_ENTRIES

Bits	Bit Name	Settings	Description	Reset	Access
7	Reserved		Reserved	0x0	R
[6:0]	FIFO_ENTRIES		Number of data samples stored in the FIFO	0x0	R

TEMPERATURE DATA REGISTERS

These two registers contain the uncalibrated temperature data. The nominal intercept is 1885 LSB at 25°C and the nominal slope is -9.05 LSB/°C. TEMP2 contains the four most significant bits, and TEMP1 contains the eight least significant bits of the 12-bit value. The ADXL359 temperature value is not double buffered, meaning the value can update between reading of the two registers.

Address: 0x06, Reset: 0x00, Name: TEMP2

Table 20. Bit Descriptions for TEMP2

Bits	Bit Name	Settings	Description	Reset	Access
[7:4]	Reserved		Reserved		
[3:0]	Temperature, Bits[11:8]		Uncalibrated temperature data	0x0	R

Address: 0x07, Reset: 0x00, Name: TEMP1

Table 21. Bit Descriptions for TEMP1

Bits	Bit Name	Settings	Description	Reset	Access
[7:0]	Temperature, Bits[7:0]		Uncalibrated temperature data	0x00	R

X-AXIS DATA REGISTERS

These three registers contain the x-axis acceleration data. Data is left justified and formatted as twos complement.

Address: 0x08, Reset: 0x00, Name: XDATA3

Table 22. Bit Descriptions for XDATA3

Bits	Bit Name	Settings	Description	Reset	Access
[7:0]	XDATA, Bits[19:12]		X-axis data	0x00	R

Address: 0x09, Reset: 0x00, Name: XDATA2

Table 23. Bit Descriptions for XDATA2

Bits	Bit Name	Settings	Description	Reset	Access
[7:0]	XDATA, Bits[11:4]		X-axis data	0x00	R

REGISTER DEFINITIONS

Address: 0x0A, Reset: 0x00, Name: XDATA1

Table 24. Bit Descriptions for XDATA1

Bits	Bit Name	Settings	Description	Reset	Access
[7:4]	XDATA, Bits[3:0]		X-axis data	0x0	R
[3:0]	Reserved		Reserved	0x0	R

Y-AXIS DATA REGISTERS

These three registers contain the y-axis acceleration data. Data is left justified and formatted as twos complement.

Address: 0x0B, Reset: 0x00, Name: YDATA3

Table 25. Bit Descriptions for YDATA3

Bits	Bit Name	Settings	Description	Reset	Access
[7:0]	YDATA, Bits[19:12]		Y-axis data	0x00	R

Address: 0x0C, Reset: 0x00, Name: YDATA2

Table 26. Bit Descriptions for YDATA2

Bits	Bit Name	Settings	Description	Reset	Access
[7:0]	YDATA, Bits[11:4]		Y-axis data	0x00	R

Address: 0x0D, Reset: 0x00, Name: YDATA1

Table 27. Bit Descriptions for YDATA1

Bits	Bit Name	Settings	Description	Reset	Access
[7:4]	YDATA, Bits[3:0]		Y-axis data	0x0	R
[3:0]	Reserved		Reserved	0x0	R

Z-AXIS DATA REGISTERS

These three registers contain the z-axis acceleration data. Data is left justified and formatted as twos complement.

Address: 0x0E, Reset: 0x00, Name: ZDATA3

Table 28. Bit Descriptions for ZDATA3

Bits	Bit Name	Settings	Description	Reset	Access
[7:0]	ZDATA, Bits[19:12]		Z-axis data	0x00	R

Address: 0x0F, Reset: 0x00, Name: ZDATA2

Table 29. Bit Descriptions for ZDATA2

Bits	Bit Name	Settings	Description	Reset	Access
[7:0]	ZDATA, Bits[11:4]		Z-axis data	0x00	R

Address: 0x10, Reset: 0x00, Name: ZDATA1

Table 30. Bit Descriptions for ZDATA1

Bits	Bit Name	Settings	Description	Reset	Access
[7:4]	ZDATA, Bits[3:0]		Z-axis data	0x0	R
[3:0]	Reserved		Reserved	0x0	R

REGISTER DEFINITIONS

FIFO ACCESS REGISTER

Address: 0x11, Reset: 0x00, Name: FIFO_DATA

Read this register to access data stored in the FIFO.

Table 31. Bit Descriptions for FIFO_DATA

Bits	Bit Name	Settings	Description	Reset	Access
[7:0]	FIFO_DATA		FIFO data is formatted to 24 bits, three bytes, most significant byte first. A read to this address pops an effective three equal byte words of axis data from the FIFO. Two subsequent reads or a multibyte read completes the transaction of this data onto the interface. Continued reading or a sustained multibyte read of this field continues to pop the FIFO every third byte. Multibyte reads to this address do not increment the address pointer. If this address is read due to an auto-increment from the previous address, it does not pop the FIFO. Instead, it returns zeros and increments on to the next address.	0x0	R

X-AXIS OFFSET TRIM REGISTERS

Address: 0x1E, Reset: 0x00, Name: OFFSET_X_H

Table 32. Bit Descriptions for OFFSET_X_H

Bits	Bit Name	Settings	Description	Reset	Access
[7:0]	OFFSET_X, Bits[15:8]		Offset added to x-axis data after all other signal processing. Data is in twos complement format. The significance of OFFSET_X, Bits[15:0] matches the significance of XDATA, Bits[19:4].	0x0	R/W

Address: 0x1F, Reset: 0x00, Name: OFFSET_X_L

Table 33. Bit Descriptions for OFFSET_X_L

Bits	Bit Name	Settings	Description	Reset	Access
[7:0]	OFFSET_X, Bits[7:0]		Offset added to x-axis data after all other signal processing. Data is in twos complement format. The significance of OFFSET_X, Bits[15:0] matches the significance of XDATA, Bits[19:4].	0x0	R/W

Y-AXIS OFFSET TRIM REGISTERS

Address: 0x20, Reset: 0x00, Name: OFFSET_Y_H

Table 34. Bit Descriptions for OFFSET_Y_H

Bits	Bit Name	Settings	Description	Reset	Access
[7:0]	OFFSET_Y, Bits[15:8]		Offset added to y-axis data after all other signal processing. Data is in twos complement format. The significance of OFFSET_Y, Bits[15:0] matches the significance of YDATA, Bits[19:4].	0x0	R/W

Address: 0x21, Reset: 0x00, Name: OFFSET_Y_L

Table 35. Bit Descriptions for OFFSET_Y_L

Bits	Bit Name	Settings	Description	Reset	Access
[7:0]	OFFSET_Y, Bits[7:0]		Offset added to y-axis data after all other signal processing. Data is in twos complement format. The significance of OFFSET_Y, Bits[15:0] matches the significance of YDATA, Bits[19:4].	0x0	R/W

REGISTER DEFINITIONS

Z-AXIS OFFSET TRIM REGISTERS

Address: 0x22, Reset: 0x00, Name: OFFSET_Z_H

Table 36. Bit Descriptions for OFFSET_Z_H

Bits	Bit Name	Settings	Description	Reset	Access
[7:0]	OFFSET_Z, Bits[15:8]		Offset added to z-axis data after all other signal processing. Data is in twos complement format. The significance of OFFSET_Z, Bits[15:0] matches the significance of ZDATA, Bits[19:4].	0x0	R/W

Address: 0x23, Reset: 0x00, Name: OFFSET_Z_L

Table 37. Bit Descriptions for OFFSET_Z_L

Bits	Bit Name	Settings	Description	Reset	Access
[7:0]	OFFSET_Z, Bits[7:0]		Offset added to z-axis data after all other signal processing. Data is in twos complement format. The significance of OFFSET_Z, Bits[15:0] matches the significance of ZDATA, Bits[19:4].	0x0	R/W

ACTIVITY ENABLE REGISTER

Address: 0x24, Reset: 0x00, Name: ACT_EN

Table 38. Bit Descriptions for ACT_EN

Bits	Bit Name	Settings	Description	Reset	Access
[7:3]	Reserved		Reserved.	0x0	R
2	ACT_Z		Z-axis data is a component of the activity detection algorithm.	0x0	R/W
1	ACT_Y		Y-axis data is a component of the activity detection algorithm.	0x0	R/W
0	ACT_X		X-axis data is a component of the activity detection algorithm.	0x0	R/W

ACTIVITY THRESHOLD REGISTERS

Address: 0x25, Reset: 0x00, Name: ACT_THRESH_H

Table 39. Bit Descriptions for ACT_THRESH_H

Bits	Bit Name	Settings	Description	Reset	Access
[7:0]	ACT_THRESH, Bits[15:8]		Threshold for activity detection. Acceleration magnitude must be above ACT_THRESH to trigger the activity counter. ACT_THRESH is an unsigned magnitude. The significance of ACT_THRESH, Bits[15:0] matches the significance of Bits[18:3] of XDATA, YDATA, and ZDATA.	0x0	R/W

Address: 0x26, Reset: 0x00, Name: ACT_THRESH_L

Table 40. Bit Descriptions for ACT_THRESH_L

Bits	Bit Name	Settings	Description	Reset	Access
[7:0]	ACT_THRESH, Bits[7:0]		Threshold for activity detection. The acceleration magnitude must be greater than the value in ACT_THRESH to trigger the activity counter. ACT_THRESH is an unsigned magnitude. The significance of ACT_THRESH, Bits[15:0] matches the significance of Bits[18:3] of XDATA, YDATA, and ZDATA.	0x0	R/W

REGISTER DEFINITIONS

ACTIVITY COUNT REGISTER

Address: 0x27, Reset: 0x01, Name: ACT_COUNT

Table 41. Bit Descriptions for ACT_COUNT

Bits	Bit Name	Settings	Description	Reset	Access
[7:0]	ACT_COUNT		Number of consecutive events above threshold (from ACT_THRESH) required to detect activity	0x1	R/W

FILTER SETTINGS REGISTER

Address: 0x28, Reset: 0x00, Name: Filter

Use this register to specify parameters for the internal high-pass and low-pass filters.

Table 42. Bit Descriptions for Filter

Bits	Bit Name	Settings	Description	Reset	Access
7	Reserved		Reserved	0x0	R
[6:4]	HPF_CORNER		-3 dB filter corner for the first-order, high-pass filter relative to the ODR 000 Not applicable, no high-pass filter enabled 001 $24.7 \times 10^{-4} \times \text{ODR}$ 010 $6.2084 \times 10^{-4} \times \text{ODR}$ 011 $1.5545 \times 10^{-4} \times \text{ODR}$ 100 $0.3862 \times 10^{-4} \times \text{ODR}$ 101 $0.0954 \times 10^{-4} \times \text{ODR}$ 110 $0.0238 \times 10^{-4} \times \text{ODR}$	0x0	R/W
[3:0]	ODR_LPF		ODR and low-pass filter corner 0000 4000 Hz and 1000 Hz 0001 2000 Hz and 500 Hz 0010 1000 Hz and 250 Hz 0011 500 Hz and 125 Hz 0100 250 Hz and 62.5 Hz 0101 125 Hz and 31.25 Hz 0110 62.5 Hz and 15.625 Hz 0111 31.25 Hz and 7.813 Hz 1000 15.625 Hz and 3.906 Hz 1001 7.813 Hz and 1.953 Hz 1010 3.906 Hz and 0.977 Hz	0x0	R/W

FIFO SAMPLES REGISTER

Address: 0x29, Reset: 0x60, Name: FIFO_SAMPLES

Use the FIFO_SAMPLES value to specify the number of samples to store in the FIFO. The default value of this register is 0x60 to avoid triggering the FIFO watermark interrupt.

Table 43. Bit Descriptions for FIFO_SAMPLES

Bits	Bit Name	Settings	Description	Reset	Access
7	Reserved		Reserved.	0x0	R
[6:0]	FIFO_SAMPLES		Watermark number of samples stored in the FIFO that triggers a FIFO_FULL condition. Values range from 1 to 96.	0x60	R/W

REGISTER DEFINITIONS

INTERRUPT PIN (INTX) FUNCTION MAP REGISTER

Address: 0x2A, Reset: 0x00, Name: INT_MAP

The INT_MAP register configures the interrupt pins. Bits[7:0] select which functions generate an interrupt on the INT1 and INT2 pins. Multiple events can be configured. If the corresponding bit is set to 1, the function generates an interrupt on the interrupt pins.

Table 44. Bit Descriptions for INT_MAP

Bits	Bit Name	Settings	Description	Reset	Access
7	ACT_EN2		Activity interrupt enable on INT2	0x0	R/W
6	OVR_EN2		FIFO_OVR interrupt enable on INT2	0x0	R/W
5	FULL_EN2		FIFO_FULL interrupt enable on INT2	0x0	R/W
4	RDY_EN2		DATA_RDY interrupt enable on INT2	0x0	R/W
3	ACT_EN1		Activity interrupt enable on INT1	0x0	R/W
2	OVR_EN1		FIFO_OVR interrupt enable on INT1	0x0	R/W
1	FULL_EN1		FIFO_FULL interrupt enable on INT1	0x0	R/W
0	RDY_EN1		DATA_RDY interrupt enable on INT1	0x0	R/W

DATA SYNCHRONIZATION

Address: 0x2B, Reset: 0x00, Name: Sync

Use this register to control the external timing triggers.

Table 45. Bit Descriptions for Sync

Bits	Bit Name	Settings	Description	Reset	Access
[7:3]	Reserved		Reserved.	0x0	R
2	EXT_CLK		Enable external clock. See Table 12 for configuration details.	0x0	R/W
[1:0]	EXT_SYNC		Enable external synchronization control.	0x0	R/W
		00	Internal synchronization.		
		01	External synchronization, no interpolation filter. After synchronization, and for EXT_SYNC within specification, DATA_RDY occurs on EXT_SYNC.		
		10	External synchronization, interpolation filter, next available data indicated by DATA_RDY 14 to 8204 oscillator cycles later (longer delay for higher ODR_LPF setting), data represents a sample point group delay earlier in time.		
		11	Reserved.		

I²C SPEED, INTERRUPT POLARITY, AND RANGE REGISTER

Address: 0x2C, Reset: 0x81, Name: Range

Table 46. Bit Descriptions for Range

Bits	Bit Name	Settings	Description	Reset	Access
7	I2C_HS		I ² C speed. 1 High speed mode. 0 Fast mode.	0x1	R/W
6	INT_POL		Interrupt polarity. 0 INT1 and INT2 are active low. 1 INT1 and INT2 are active high.	0x0	R/W
[5:2]	Reserved		Reserved.	0x0	R
[1:0]	Range		Range. 01 ±10 g. 10 ±20 g.	0x1	R/W

REGISTER DEFINITIONS

Table 46. Bit Descriptions for Range

Bits	Bit Name	Settings	Description	Reset	Access
			11 ±40 g.		

POWER CONTROL REGISTER

Address: 0x2D, Reset: 0x01, Name: POWER_CTL

Table 47. Bit Descriptions for POWER_CTL

Bits	Bit Name	Settings	Description	Reset	Access
[7:3]	Reserved		Reserved.	0x0	R
2	DRDY_OFF		Set to 1 to force the DRDY output to 0 in modes where it is normally signal data ready.	0x0	R/W
1	TEMP_OFF		Set to 1 to disable temperature processing. Temperature processing is also disabled when standby = 1.	0x0	R/W
0	Standby		Standby or measurement mode. 1 Standby mode. In standby mode, the device is in a low power state, and the temperature and acceleration datapaths are not operating. In addition, digital functions, including FIFO pointers, reset. Changes to the configuration setting of the device must be made when standby = 1. An exception is a high-pass filter that can be changed when the device is operating. 0 Measurement mode.	0x1	R/W

SELF TEST REGISTER

Address: 0x2E, Reset: 0x00, Name: SELF_TEST

Refer to the [Self Test](#) section for more information on the operation of the self test feature.

Table 48. Bit Descriptions for SELF_TEST

Bits	Bit Name	Settings	Description	Reset	Access
[7:2]	Reserved		Reserved.	0x0	R
1	ST2		Set to 1 to enable self test force	0x0	R/W
0	ST1		Set to 1 to enable self test mode	0x0	R/W

RESET REGISTER

Address: 0x2F, Reset: 0x00, Name: Reset

Table 49. Bit Descriptions for Reset

Bits	Bit Name	Settings	Description	Reset	Access
[7:0]	Reset		Write Code 0x52 to reset the device, similar to a power-on reset (POR)	0x0	W

In case of a software reset, an unlikely race condition may occur in products with REVID = 0x01 or earlier. If the race condition occurs, some factory settings in the NVM load incorrectly to shadow registers (the registers from which the internal logic configures the sensor and calculates the output after a power-on or a software reset). The incorrect loading of the NVM affects overall performance of the sensor, such as an incorrect 0 g bias and other performance issues. The incorrect loading of NVM does not occur from a power-on or after a power cycle. To guarantee reliable operation of the sensor after a software reset, the user can access the shadow registers after a power-on, read and store the values on the host microprocessor, and compare the values read from the same shadow registers after a software reset. This method guarantees proper operation in all devices and under all conditions. The recommended steps are as follows:

1. Read the shadow registers, Register 0x50 to Register 0x54 (five 8-bit registers) after power-up, but before any software reset.
2. Store these values in a host device (for example, a host microprocessor).
3. After each software reset, read the same five registers. If the values differ, perform a software reset again until they match.

RECOMMENDED SOLDERING PROFILE

Figure 46 and Table 50 provide details about the recommended soldering profile.

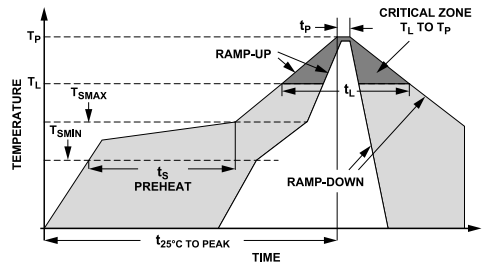

Figure 46. Recommended Soldering Profile

Table 50. Recommended Soldering Profile

Profile Feature	Condition	
	Sn63/Pb37	Pb-Free
Average Ramp Rate from Liquid Temperature (T_L) to Peak Temperature (T_P)	3°C/sec maximum	3°C/sec maximum
Preheat		
Minimum Temperature (T_{SMIN})	100°C	150°C
Maximum Temperature (T_{SMAX})	150°C	200°C
Time from T_{SMIN} to T_{SMAX} (t_s)	60 sec to 120 sec	60 sec to 180 sec
T_{SMAX} to T_L Ramp-Up Rate	3°C/sec maximum	3°C/sec maximum
Liquid Temperature (T_L)	183°C	217°C
Time Maintained Above T_L (t_L)	60 sec to 150 sec	60 sec to 150 sec
Peak Temperature (T_P)	240°C + 0°C/-5°C	260°C + 0°C/-5°C
Time of Actual T_P - 5°C (t_p)	10 sec to 30 sec	20 sec to 40 sec
Ramp-Down Rate	6°C/sec maximum	6°C/sec maximum
Time from 25°C to Peak Temperature ($t_{25°C TO PEAK}$)	6 minutes maximum	8 minutes maximum

PCB FOOTPRINT PATTERN

Figure 47 shows the PCB footprint pattern and dimensions in millimeters.

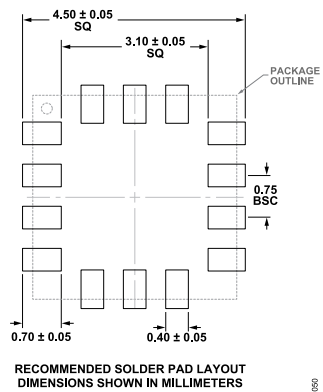

Figure 47. PCB Footprint Pattern and Dimensions in Millimeters

OUTLINE DIMENSIONS

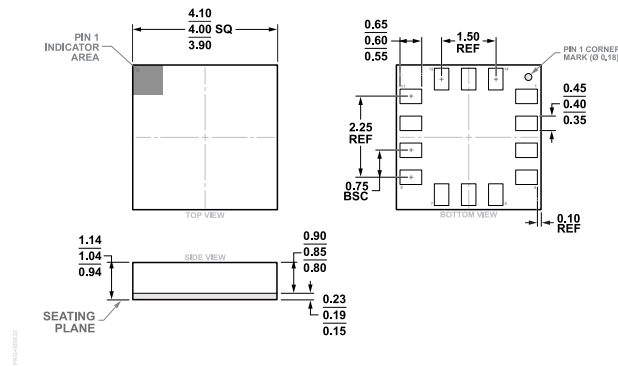

Figure 48. 14-Terminal Land Grid Array [LGA] (CC-14-2) Dimensions shown in millimeters

Updated: June 03, 2022

ORDERING GUIDE

Model ¹	Temperature Range	Package Description	Packing Quantity	Package Option
ADXL359BCCZ	-40°C to +125°C	14-Terminal Land Grid Array [LGA]		CC-14-2
ADXL359BCCZ-RL	-40°C to +125°C	14-Terminal Land Grid Array [LGA]	Reel, 4000	CC-14-2
ADXL359BCCZ-RL7	-40°C to +125°C	14-Terminal Land Grid Array [LGA]	Reel, 1000	CC-14-2

¹ Z = RoHS Compliant Part.

OUTPUT MODE, MEASUREMENT RANGE, AND SPECIFIED VOLTAGE OPTIONS

Table 51. Output Mode, Measurement Range, and Specified Voltage Options

Model ¹	Output Mode	Measurement Mode (g)	Specified Voltage (V)
ADXL359BCCZ	Digital	±10, ±20, ±40	3.3
ADXL359BCCZ-RL	Digital	±10, ±20, ±40	3.3
ADXL359BCCZ-RL7	Digital	±10, ±20, ±40	3.3

¹ Z = RoHS-Compliant Part.

EVALUATION BOARDS

Model ¹	Description
EVAL-ADXL359Z	Evaluation Board

¹ Z = RoHS-Compliant Part.

I²C refers to a communications protocol originally developed by Philips Semiconductors (now NXP Semiconductors).