

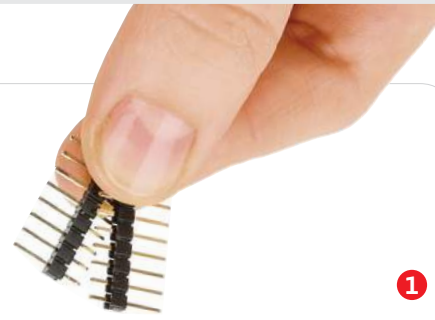

Angle click

2. Soldering the headers

Before using your click board™, make sure to solder 1x8 male headers to both left and right side of the board. Two 1x8 male headers are included with the board in the package.



2



Turn the board upside down so that the bottom side is facing you upwards. Place shorter pins of the header into the appropriate soldering pads.

3

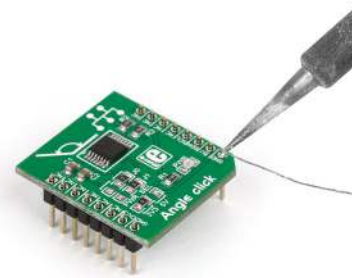

Turn the board upward again. Make sure to align the headers so that they are perpendicular to the board, then solder the pins carefully.

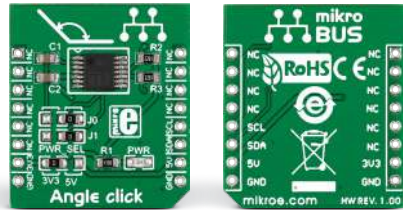

1. Introduction

Angle click carries an **A1332** contactless magnetic angle position sensor. The sensing circuitry relies on the Hall Effect to detect the vector of a nearby magnetic field in a 360° two-dimensional plane parallel to the surface of the chip. The device also includes EEPROM for storing calibration parameters. Angle click communicates with the target MCU through the mikroBUS™ I2C interface [SCL, SDA]. Designed to use either a 3.3V or a 5V power supply.

3. Plugging the board in

Once you have soldered the headers your board is ready to be placed into the desired mikroBUS™ socket. Make sure to align the cut in the lower-right part of the board with the markings on the silkscreen at the mikroBUS™ socket. If all the pins are aligned correctly, push the board all the way into the socket.

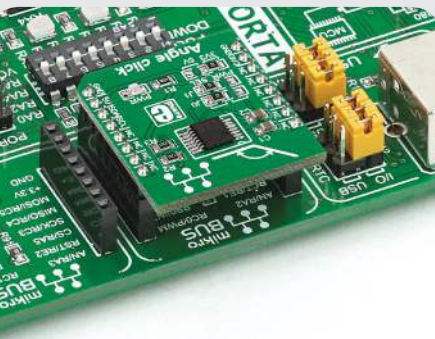
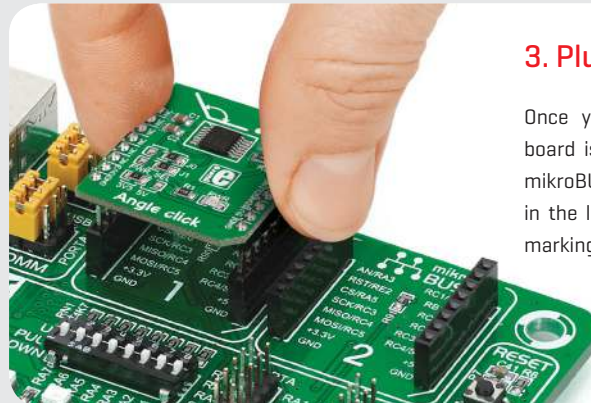

4. Essential features

Angle click is intended for use with a rotating bipolar magnetic target. The advanced linearization, offset and gain adjustment options enable a wide variety of applications. Those include setting up a digital potentiometer, sensing motor rotation, or in automotive applications for power steering and throttle sensing. With a refresh rate of 32 micro seconds and a 12-bit resolution, the A1332 delivers precise angle measurements. Furthermore, you can configure the output dynamic range, output scaling and filtering to adjust it for specific use.

click
BOARDS™
www.mikroe.com



Angle click Manual v100



0100000092477

5. Schematic

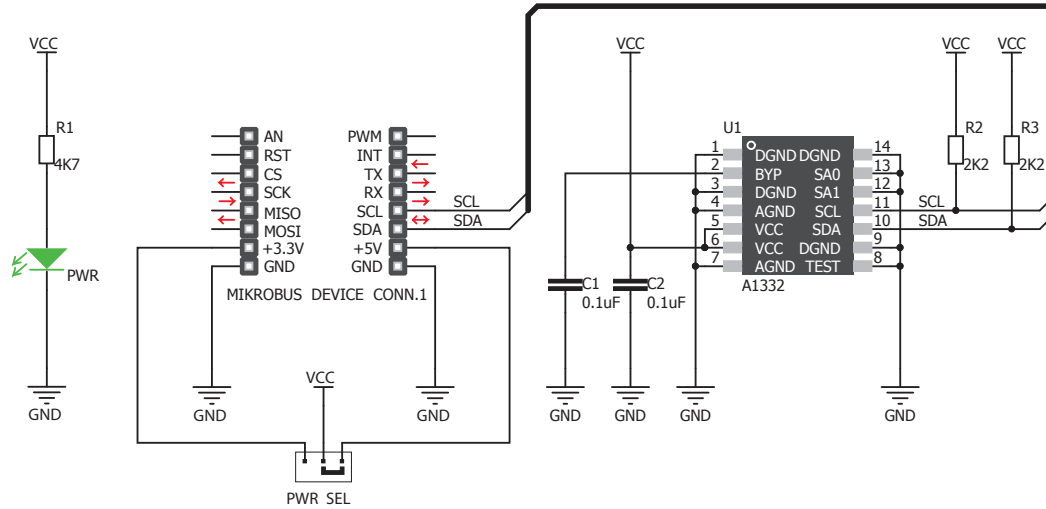

6. Dimensions

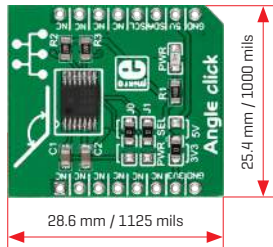

	mm	mils
LENGTH	28.6	1125
WIDTH	25.4	1000
HEIGHT*	3.3	130

* without headers

7. SMD jumper



Angle click features an SMD jumper [zero ohm resistor] that let's you switch between a 3.3V or a 5V power supply.

8. Code examples

Once you have done all the necessary preparations, it's time to get your click board™ up and running. We have provided examples for mikroC™, mikroBasic™ and mikroPascal™ compilers on our **Libstock** website. Just download them and you are ready to start.



9. Support

MikroElektronika offers **free tech support** [www.mikroe.com/support] until the end of the product's lifetime, so if something goes wrong, we're ready and willing to help!



10. Disclaimer

MikroElektronika assumes no responsibility or liability for any errors or inaccuracies that may appear in the present document. Specification and information contained in the present schematic are subject to change at any time without notice.

Copyright © 2015 MikroElektronika.
All rights reserved.