

60546-1 ✓ ACTIVE

TE Internal #: 60546-1

Ring Terminals & Spade Terminals, Ring Tongue, 18 – 14 AWG

Wire Size, .8 – 2 mm² Wire Size, 1624 – 4106 CMA Wire Size, Stud

Size #10

[View on TE.com >](#)



Terminals & Splices > Ring Terminals & Spade Terminals



Ring & Spade Terminal Type: **Ring Tongue**

Wire Size: **1624 – 4106 CMA**

Stud Size: **#10**

Features

Product Type Features

Shape Description	Extruded
Stud Size	#10
Sealable	No
Compatible With Discrete Wire Type	Stranded
Wire Insulation Support Retention Type	Insulation Support

Configuration Features

Number of Holes	1
-----------------	---

Contact Features

Contact Base Material	Brass
Ring & Spade Terminal Type	Ring Tongue
Barrel Type	Open
Terminal Orientation	Straight
Terminal Plating Material	Unplated
Contact Underplating Material	None

Mechanical Attachment

Wire Insulation Support	With
-------------------------	------



Dimensions

	.12 in
Wire Size	1624 – 4106 CMA
Stud Diameter	4.93 mm[.194 in]
Tongue Thickness	.51 mm[.02 in]
Product Length	17.53 mm[.69 in]
Barrel Inside Diameter	1.52 mm, 3.93 mm[.06 in][.155 in]
Compatible Insulation Diameter (Max)	4.32 mm[.17 in]
Compatible Insulation Diameter Range	3.05 – 4.32 mm[.12 – .17 in]

Usage Conditions

Insulation Option	Uninsulated
Operating Temperature Range	-40 – 110 °C[-40 – 230 °F]

Operation/Application

Compatible With Wire Base Material	Copper
------------------------------------	--------

Industry Standards

Government Qualified Terminal	No
-------------------------------	----

Packaging Features

Packaging Quantity	12500
Packaging Method	Strip/Reel

Product Compliance











[For compliance documentation, visit the product page on TE.com>](#)

EU RoHS Directive 2011/65/EU	Compliant
EU ELV Directive 2000/53/EC	Compliant
China RoHS 2 Directive MIIT Order No 32, 2016	No Restricted Materials Above Threshold
EU REACH Regulation (EC) No. 1907/2006	Current ECHA Candidate List: JUNE 2023 (235) Candidate List Declared Against: JUNE 2022 (224) Does not contain REACH SVHC
Halogen Content	Low Halogen - Br, Cl, F, I < 900 ppm per homogenous material. Also BFR/CFR/PVC Free
Solder Process Capability	Not applicable for solder process capability

Product Compliance Disclaimer

This information is provided based on reasonable inquiry of our suppliers and represents our current actual knowledge based on the information they provided. This information is subject to change. The part numbers that TE has identified as EU RoHS compliant have a maximum concentration of 0.1% by weight in homogenous materials for lead, hexavalent chromium, mercury, PBB, PBDE, DBP, BBP, DEHP, DIBP, and 0.01% for cadmium, or qualify for an exemption to these limits as defined in the Annexes of Directive 2011/65/EU (RoHS2). Finished electrical and electronic equipment products will be CE marked as required by Directive 2011/65/EU. Components may not be CE marked. Additionally, the part numbers that TE has identified as EU ELV compliant have a maximum concentration of 0.1% by weight in homogenous materials for lead, hexavalent chromium, and mercury, and 0.01% for cadmium, or qualify for an exemption to these limits as defined in the Annexes of Directive 2000/53/EC (ELV). Regarding the REACH Regulation, the information TE provides on SVHC in articles for this part number is based on the latest European Chemicals Agency (ECHA) 'Guidance on requirements for substances in articles' posted at this URL: <https://echa.europa.eu/guidance-documents/guidance-on-reach>

Compatible Parts

 <p>TE Part # 41330 RING 18-14 AWG TPBR</p>	 <p>TE Part # 41559 RING 18-14 AWG BR</p>	 <p>TE Part # 41558 RING 18-14 AWG BR</p>	 <p>TE Part # 41332 RING 18-14 AWG TPBR</p>
 <p>TE Part # 41333 RING 18-14 AWG TPBR</p>	 <p>TE Part # 41560 RING .190 (4.82 MM) 18-14 AWG BR</p>	 <p>TE Part # 155406-5 TONGUE,RING OPEN BARREL 18-14 AWG BR</p>	 <p>TE Part # 1217160-1 OPEN BARREL RING PHOS BRZ</p>
 <p>TE Part # 41333-2 RING TERMINAL 18-14 AWG TPBR</p>	 <p>TE Part # 63628-1 RING 0.8-2.0 MM2 PTPBR</p>		

Customers Also Bought

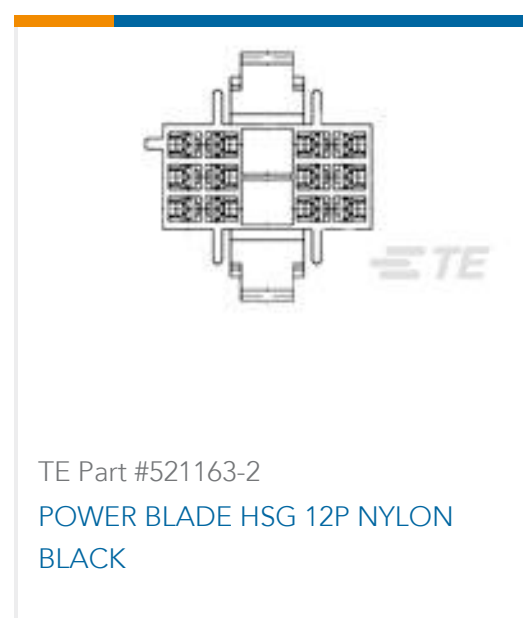
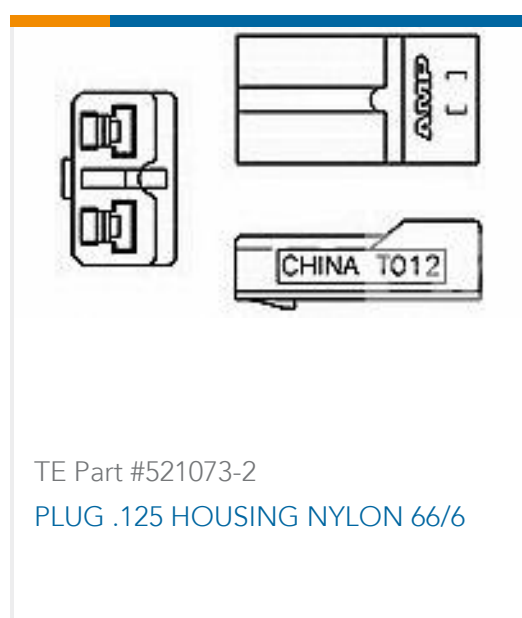
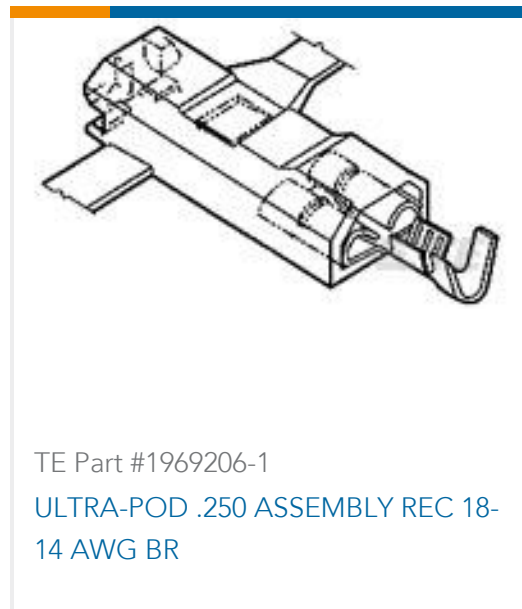

Documents

Product Drawings

[EXTRUDED RING CRIMP 18-14 AWG BR](#)

English

CAD Files

[3D PDF](#)

3D

Customer View Model

[ENG_CVM_CVM_60546-1_J_c-60546-1-j.2d_dxf.zip](#)

English

Customer View Model

[ENG_CVM_CVM_60546-1_J_c-60546-1-j.3d_igs.zip](#)

English

Customer View Model

[ENG_CVM_CVM_60546-1_J_c-60546-1-j.3d_stp.zip](#)

English

By downloading the CAD file I accept and agree to the [Terms and Conditions](#) of use.

Product Specifications



Application Specification

English

Product Environmental Compliance

TE Material Declaration

English

Agency Approvals

UL Report

English