

Power Management Switch ICs for PCs and Digital Consumer Products



# 1ch Small Package High Side Switch ICs for USB Devices and Memory Cards

## BD2248G

### ●Description

BD2248G is low on-resistance N-channel MOSFET high-side power switches, optimized for Universal Serial Bus (USB) applications. BD2248G is equipped with the function of over-current detection, thermal shutdown, under-voltage lockout and soft-start.

### ●Key Specifications

■ Input voltage range:	2.7V to 5.5V
■ ON resistance: (VIN=5V)	110mΩ(Typ.)
■ Over current threshold:	0.2A min., 0.4A max.
■ Standby current:	0.01μA (Typ.)
■ Operating temperature range:	-40°C to +85°C

### ●Features

- Reverse Current Protection when Power Switch Off
- Output Discharge Function
- Over-Current Detection
- Thermal Shutdown
- Open-Drain Fault Flag Output
- Under-Voltage Lockout
- Soft-Start Circuit
- Control Input Logic Active-High
- ESD protection

### ●Applications

USB hub in consumer appliances, Car accessory, PC, PC peripheral equipment, and so forth

### ●Package

SSOP5

(Typ.) (Typ.) (Max.)  
2.90mm x 2.80mm x 1.25mm



### ●Typical Application Circuit

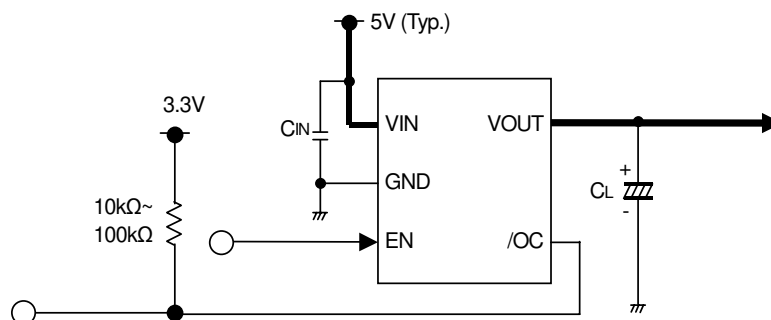

Figure 1. Typical Application Circuit

●Block Diagram

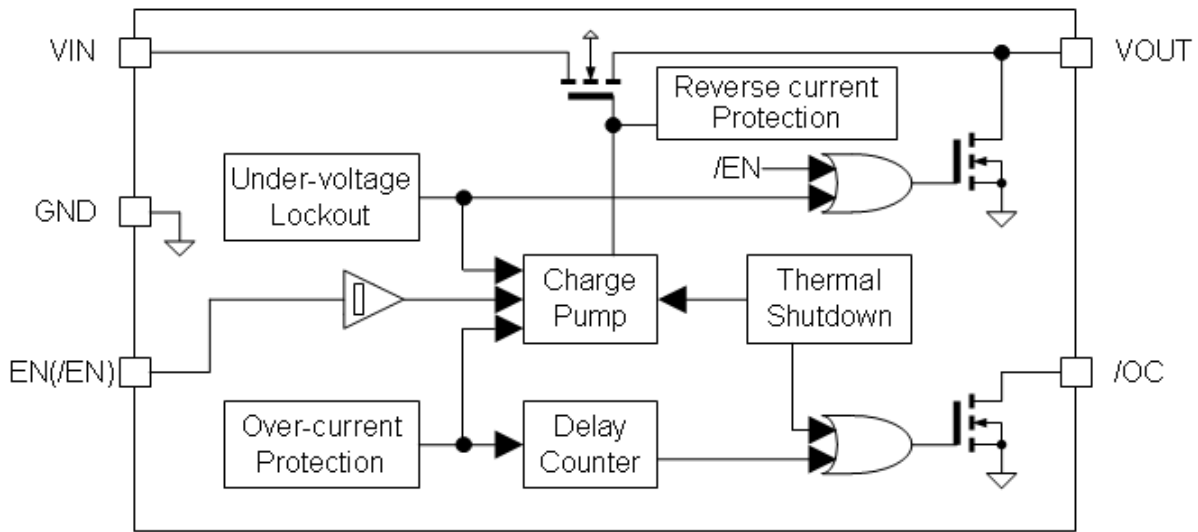

Figure 2. Block Diagram

●Pin Configuration

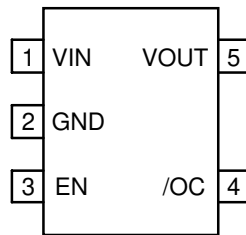

Figure 3. Pin Configuration (TOP VIEW)

●Pin Descriptions

Pin No.	Symbol	I/O	Function
1	VIN	-	Switch input and the supply voltage for the IC.
2	GND	-	Ground.
3	EN	I	Enable input. High level input turns on the switch.
4	/OC	O	Over-current notification terminal. Low level output during over-current or over-temperature condition. Open-drain fault flag output.
5	VOUT	O	Switch output.

**● Absolute Maximum Ratings (Ta=25°C)**

Parameter	Symbol	Ratings	Unit
VIN supply voltage	VIN	-0.3 to 6.0	V
EN input voltage	VEN	-0.3 to 6.0	V
/OC voltage	V/OC	-0.3 to 6.0	V
/OC sink current	I/OC	5	mA
VOUT voltage	VOUT	-0.3 to 6.0	V
Storage temperature	TSTG	-55 to 150	°C
Power dissipation	Pd	675 <sup>*1</sup>	mW

\*1 Mounted on 70mm x 70mm x 1.6mm glass epoxy board. Reduce 5.4mW per 1°C above 25°C

**● Recommended Operating Ratings**

Parameter	Symbol	Ratings			Unit
		Min.	Typ.	Max.	
VIN operating voltage	VIN	2.7	5.0	5.5	V
Operating temperature	TOPR	-40	-	85	°C

**● Electrical Characteristics (VIN= 5V, Ta= 25°C, unless otherwise specified.)**
DC Characteristics

Parameter	Symbol	Limits			Unit	Conditions
		Min.	Typ.	Max.		
Operating current	IDD	-	130	175	μA	VEN = 5V, VOUT = open, VIN = 5V
		-	90	120		VEN = 3.3V, VOUT = open, VIN = 3.3V
Standby current	ISTB	-	0.01	5	μA	VEN = 0V, VOUT = open, VIN = 5V
EN input voltage	VENH	2.0	-	-	V	High input, VIN = 3.3 to 5V
	VENL	-	-	0.8	V	Low input, VIN = 5V
-		-	0.6	Low input, VIN = 3.3V		
EN input leakage	IEN	-1	0.01	1	μA	VEN = 0V or 5V
On-resistance	RON	-	110	155	mΩ	IOUT = 100mA, VIN = 5V
		-	130	180		IOUT = 100mA, VIN = 3.3V
Reverse leak current	IREV	-	-	1	μA	VOUT = 5V, VIN = 0V
Over-current threshold	ITH	200	300	400	mA	VIN = 5V
		190	290	390		VIN = 3.3V
Short circuit output current	ISC	100	200	300	mA	VOUT = 0V, RMS, VIN = 3.3 to 5V
Output discharge resistance	RDISC	30	60	120	Ω	IDISC = 1mA, VIN = 5V
		50	100	200		IDISC = 1mA, VIN = 3.3V
/OC output low voltage	V/OC	-	-	0.4	V	I/OC = 0.5mA, VIN = 3.3 to 5V
UVLO threshold	VTUVH	2.1	2.3	2.5	V	VIN increasing
	VTUVL	2.0	2.2	2.4	V	VIN decreasing

AC Characteristics

Parameter	Symbol	Limits			Unit	Conditions
		Min.	Typ.	Max.		
Output rise time	TON1	-	1	6	ms	RL = 500Ω, VIN = 3.3 to 5V
Output turn-on time	TON2	-	1.5	10	ms	RL = 500Ω, VIN = 3.3 to 5V
Output fall time	TOFF1	-	1	20	μs	RL = 500Ω, VIN = 3.3 to 5V
Output turn-off time	TOFF2	-	3	40	μs	RL = 500Ω, VIN = 3.3 to 5V
/OC delay time	T/OC	10	15	20	ms	VIN = 5V
		11	16	21		VIN = 3.3V

● Measurement Circuit

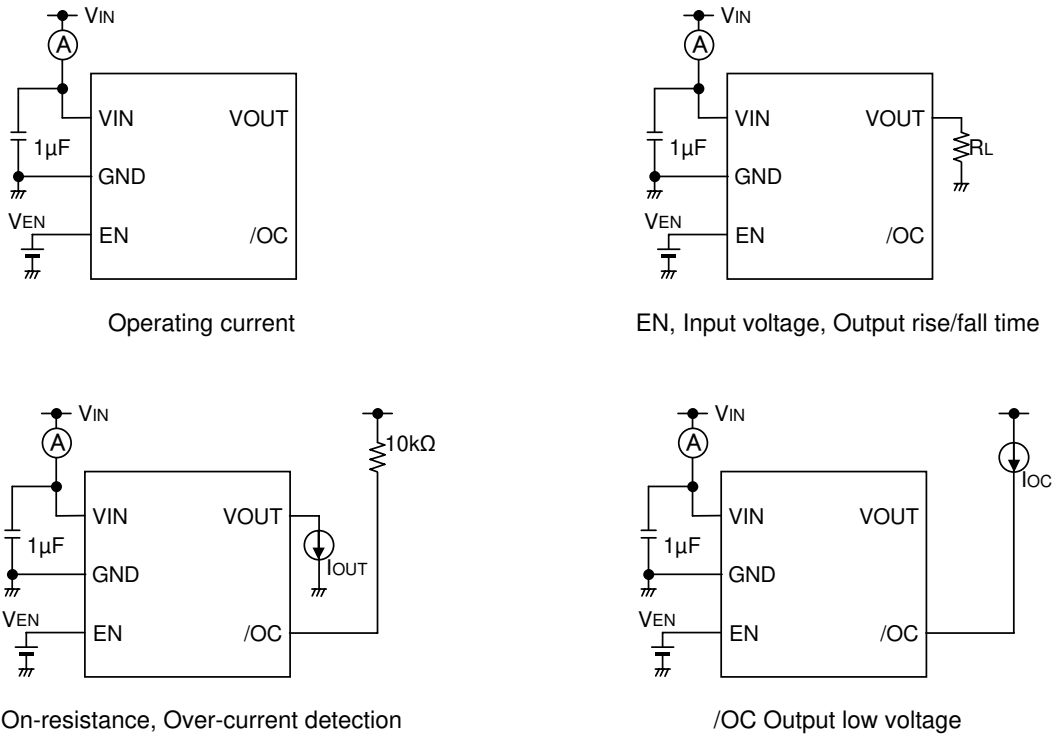

Figure 4. Measurement circuit

● Timing Diagram

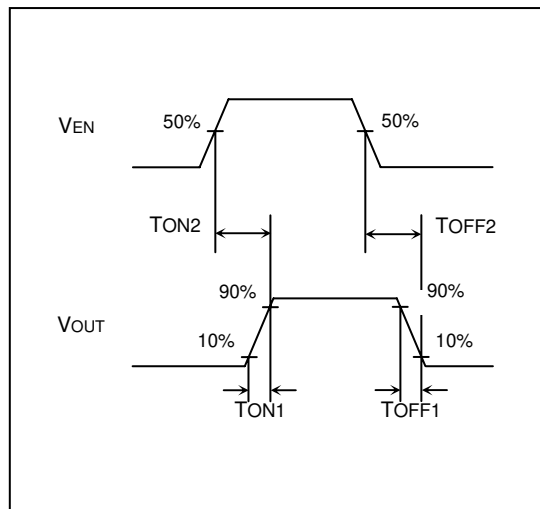

Figure 5. Output rise/fall time

● Typical Performance Curves

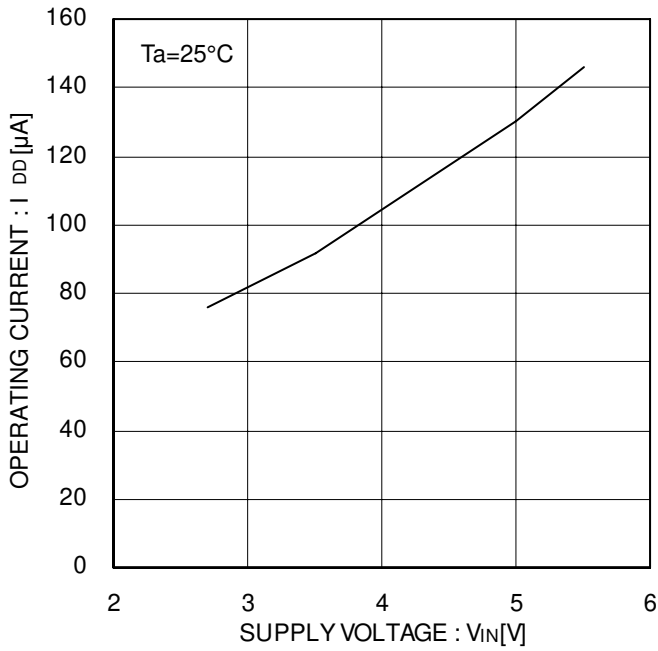

Figure 6. Operating current EN enable

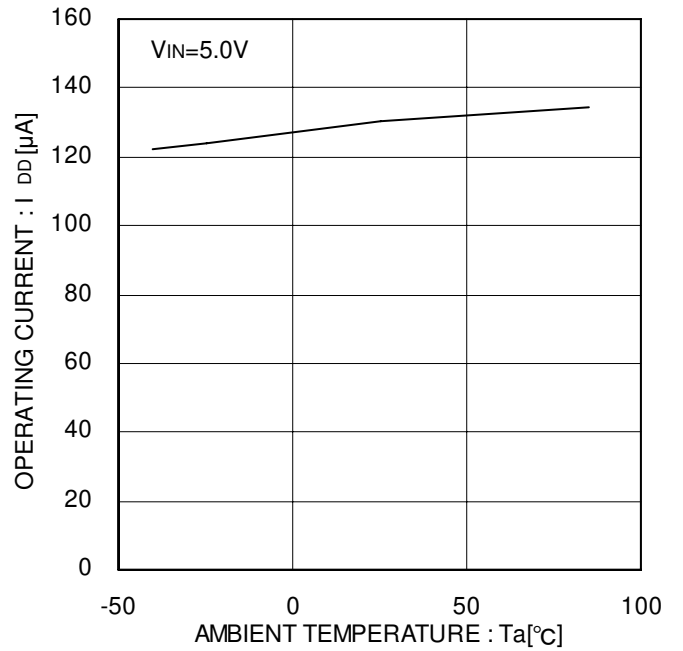

Figure 7. Operating current EN enable

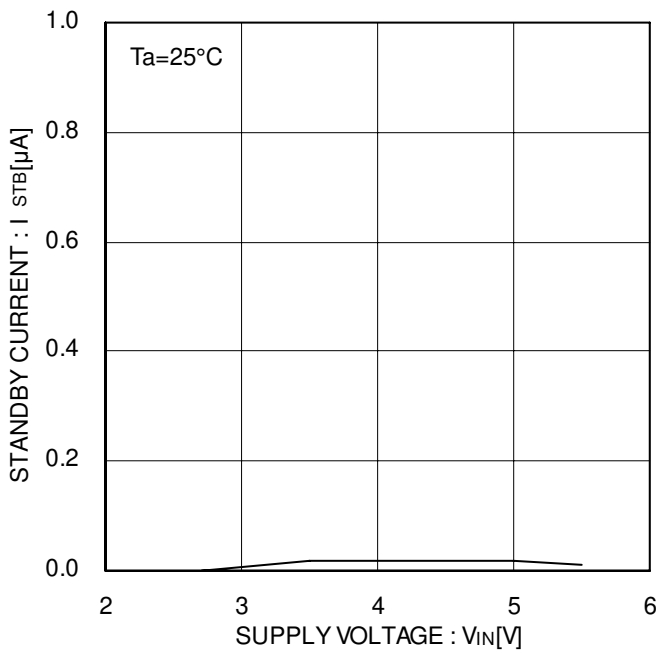

Figure 8. Standby current EN disable

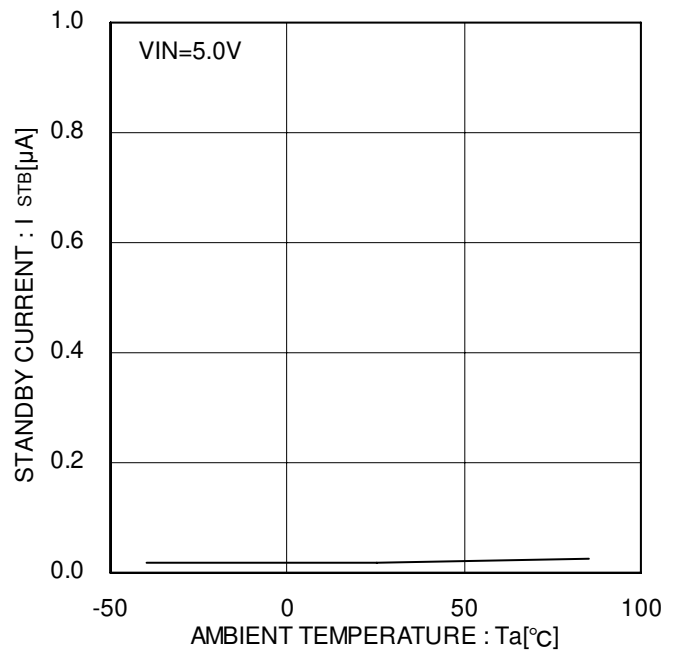

Figure 9. Standby current EN disable

● Typical Performance Curves - continued

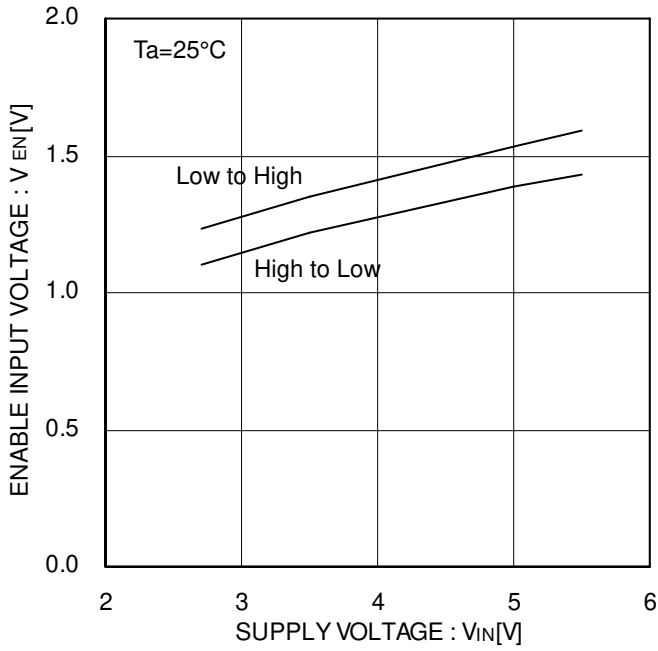

Figure 10. EN input voltage

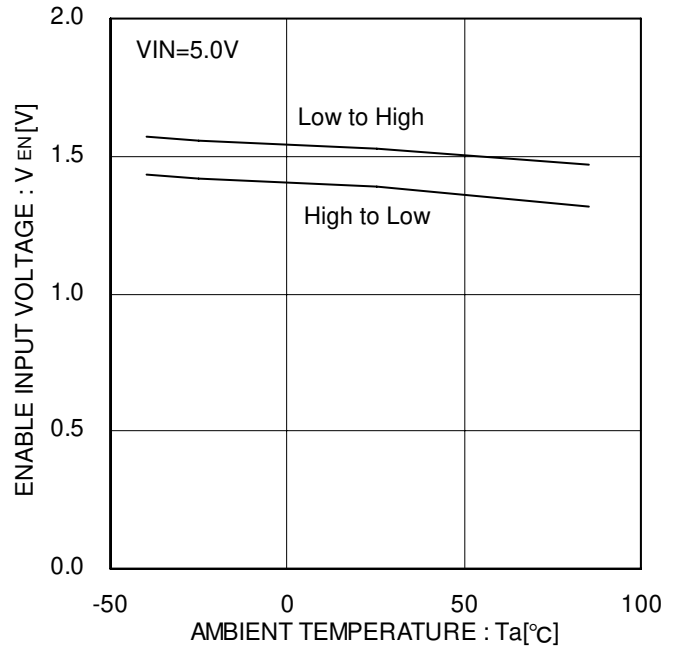

Figure 11. EN input voltage

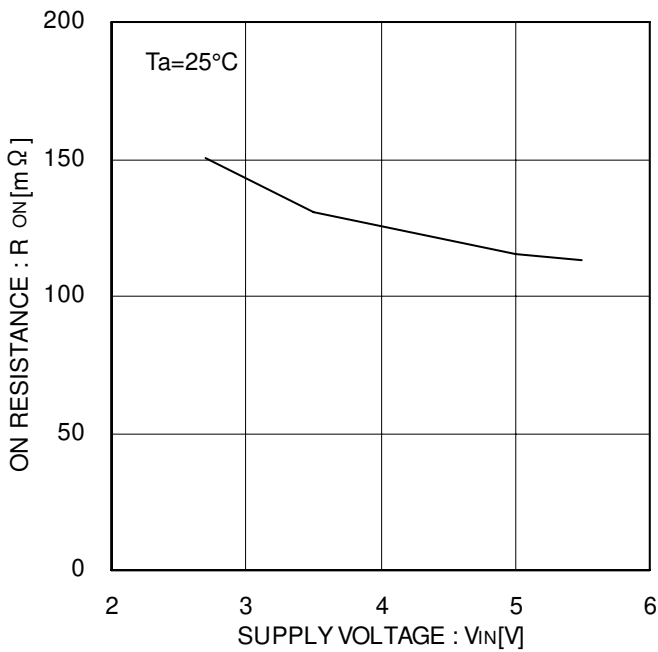

Figure 12. On-resistance

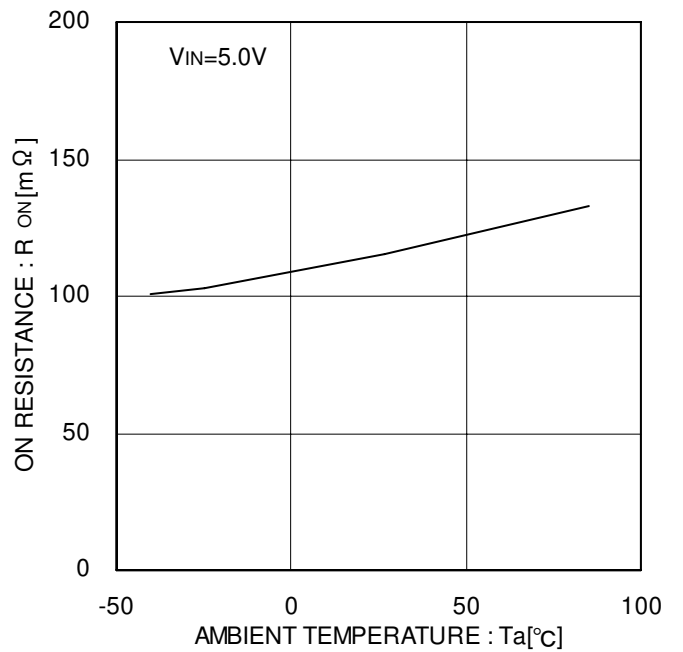

Figure 13. On-resistance

● Typical Performance Curves - continued

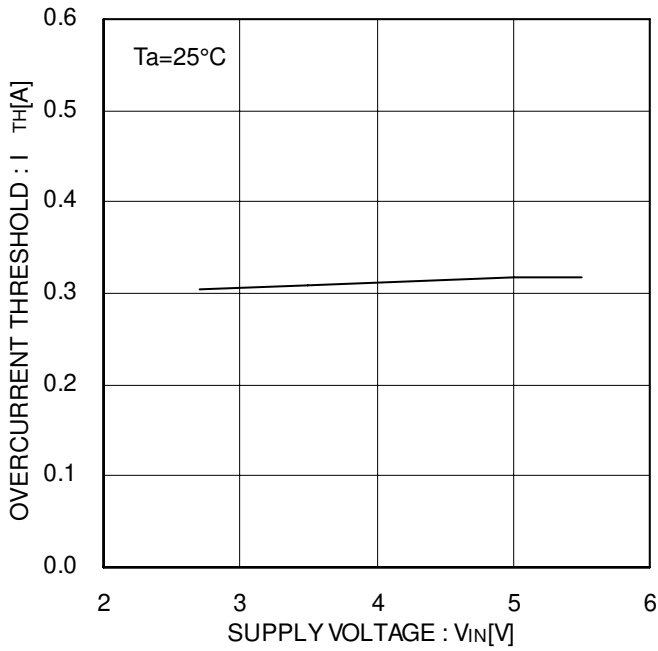

Figure 14. Over-current threshold

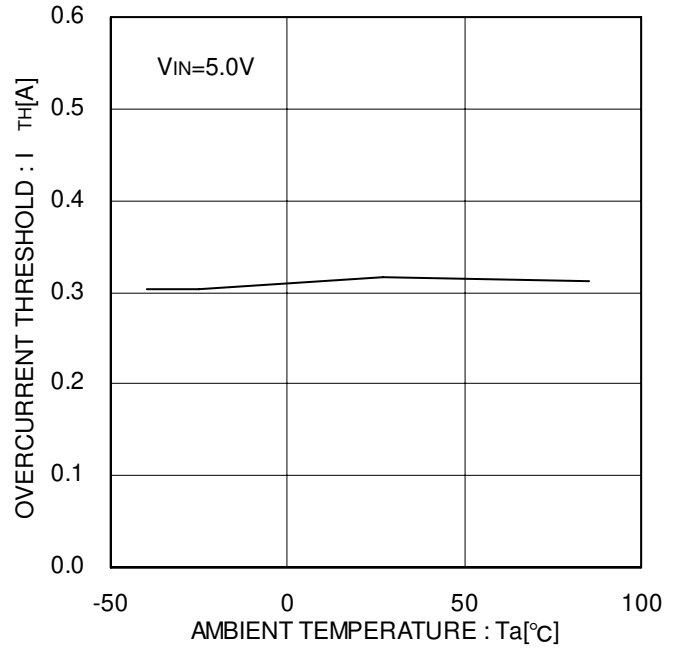

Figure 15. Over-current threshold

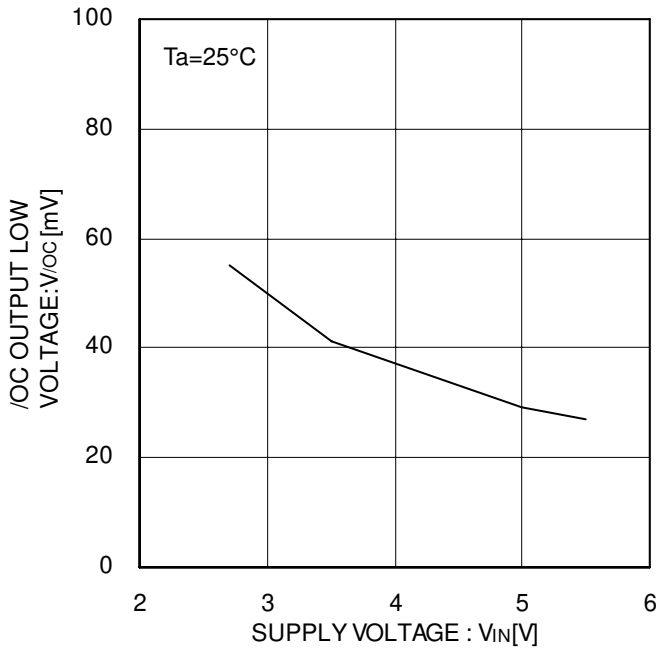

Figure 16. /OC output low voltage

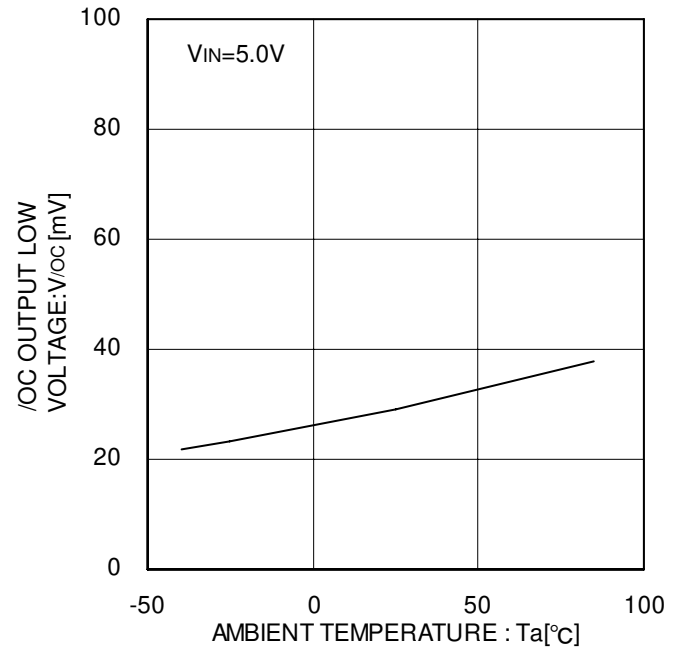

Figure 17. /OC output low voltage

● Typical Performance Curves - continued

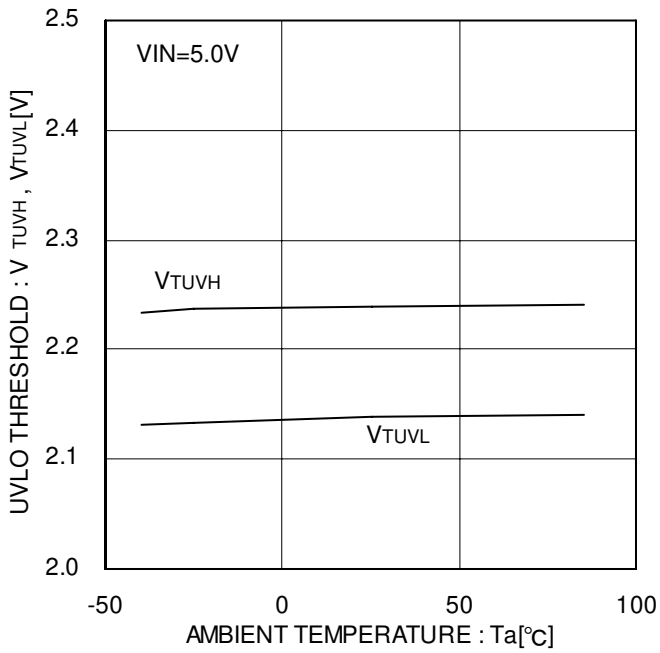

Figure 18. UVLO threshold

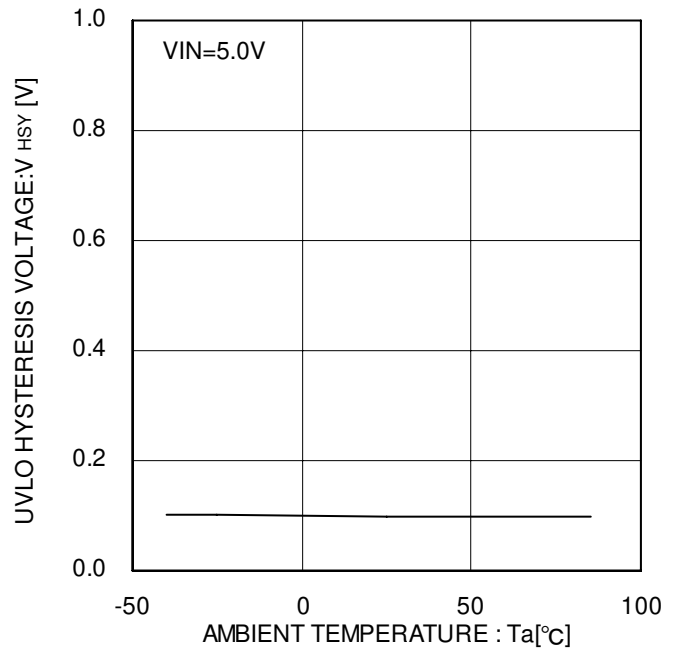

Figure 19. UVLO hysteresis voltage

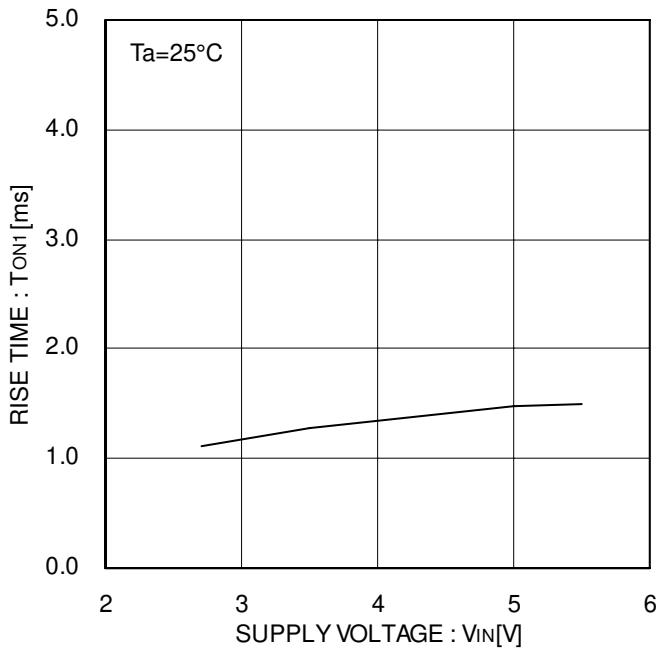

Figure 20. Output rise time

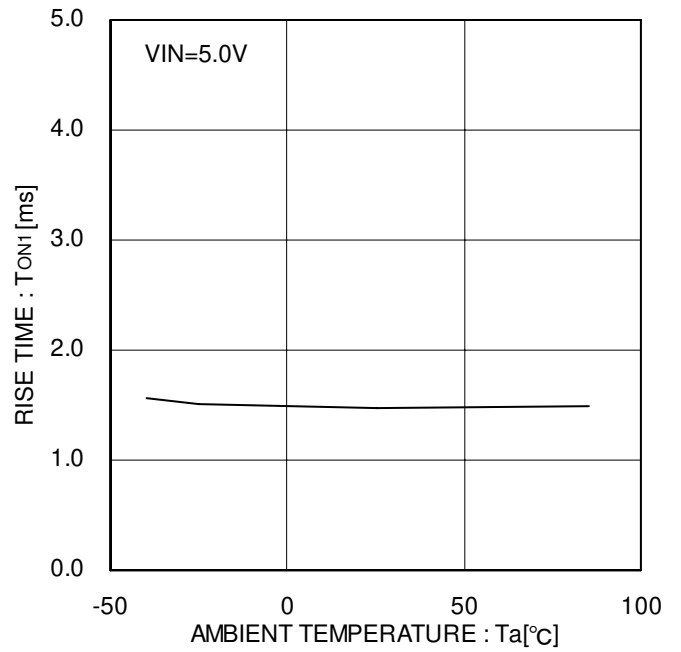

Figure 21. Output rise time



● Typical Performance Curves - continued

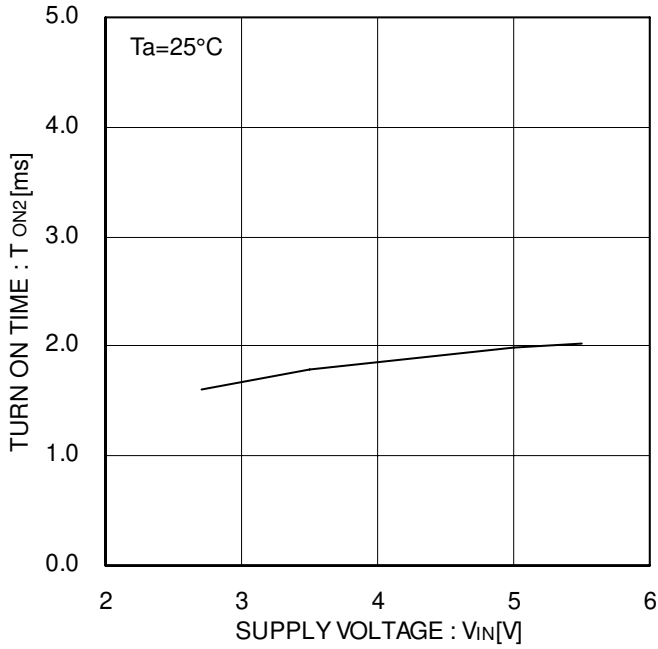

Figure 22. Output turn-on time

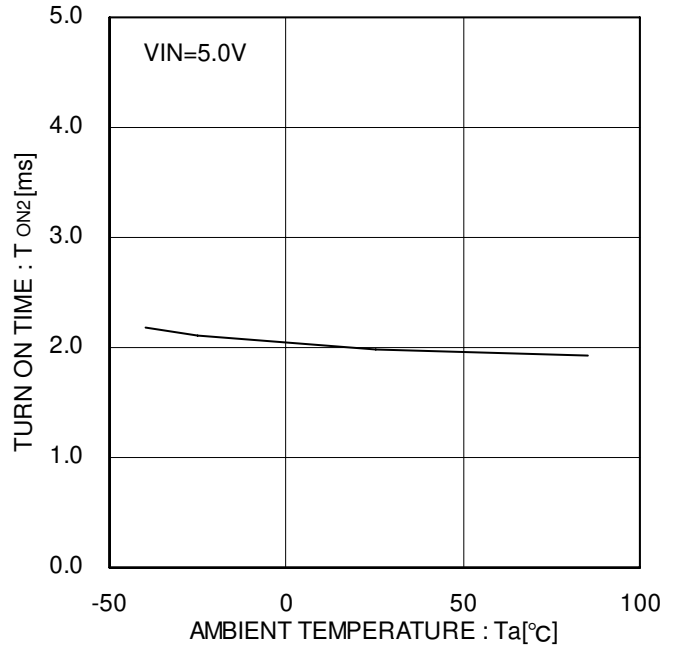

Figure 23. Output turn-on time

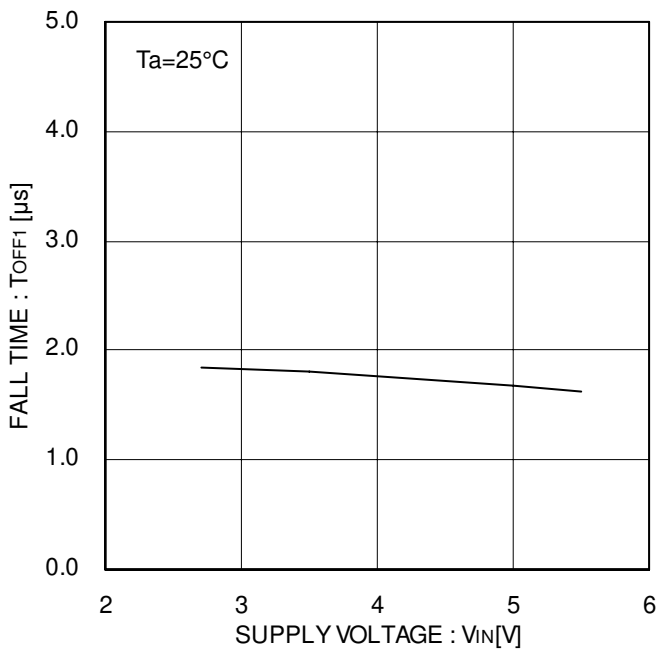

Figure 24. Output fall time

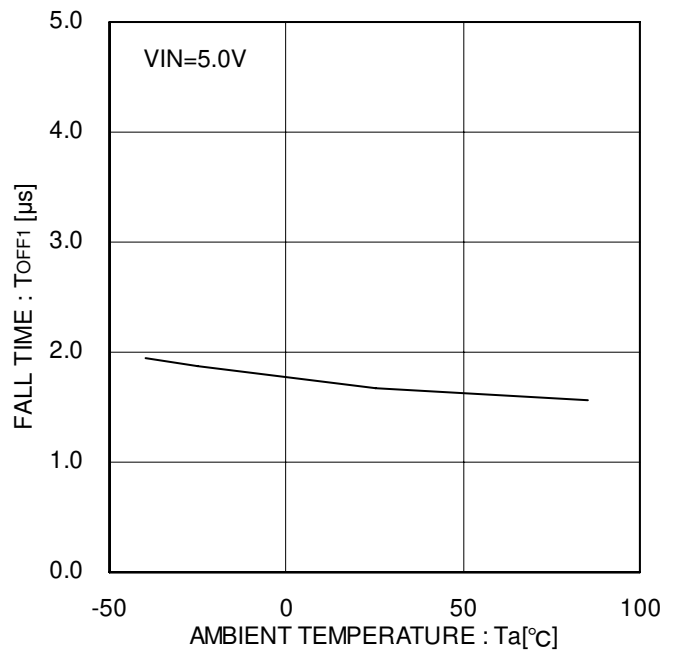

Figure 25. Output fall time

● Typical Performance Curves - continued

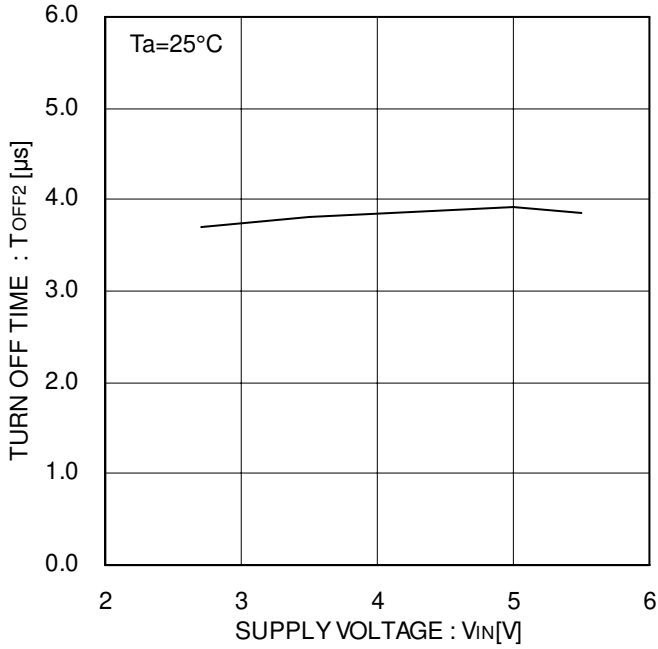

Figure 26. Output turn-off time

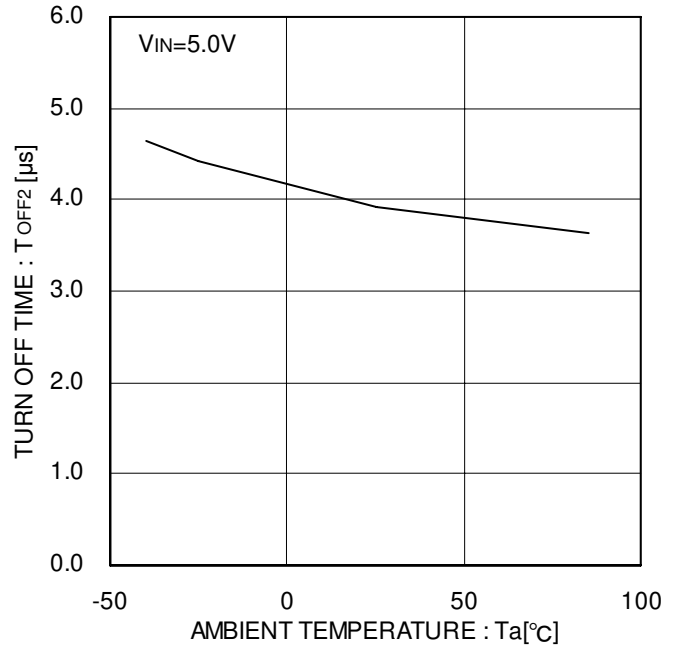

Figure 27. Output turn-off time

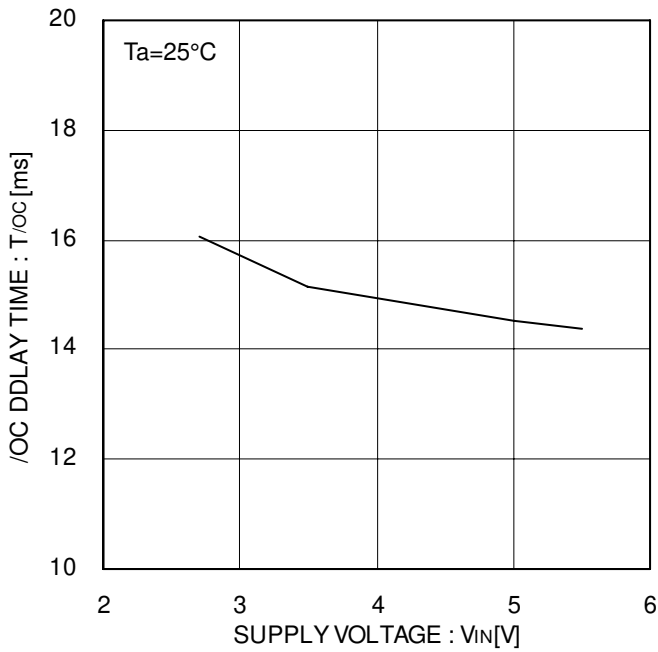

Figure 28. /OC delay time

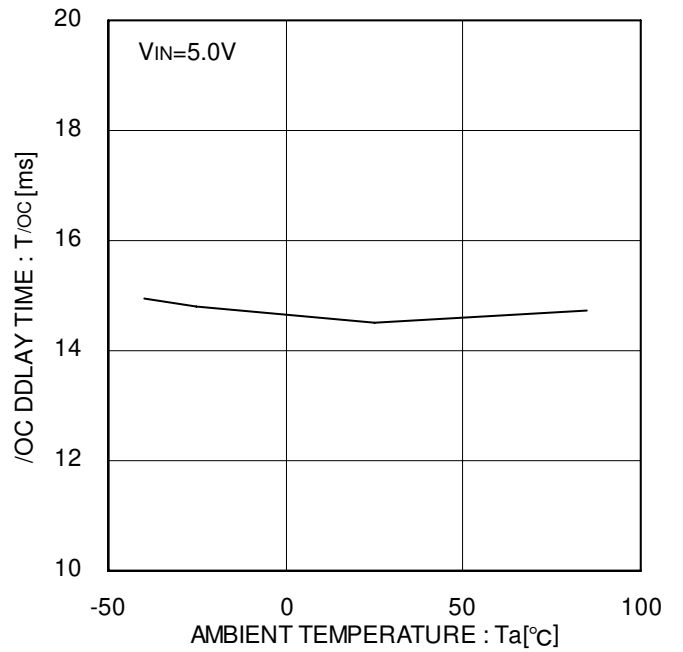

Figure 29. /OC delay time

● Typical Performance Curves - continued

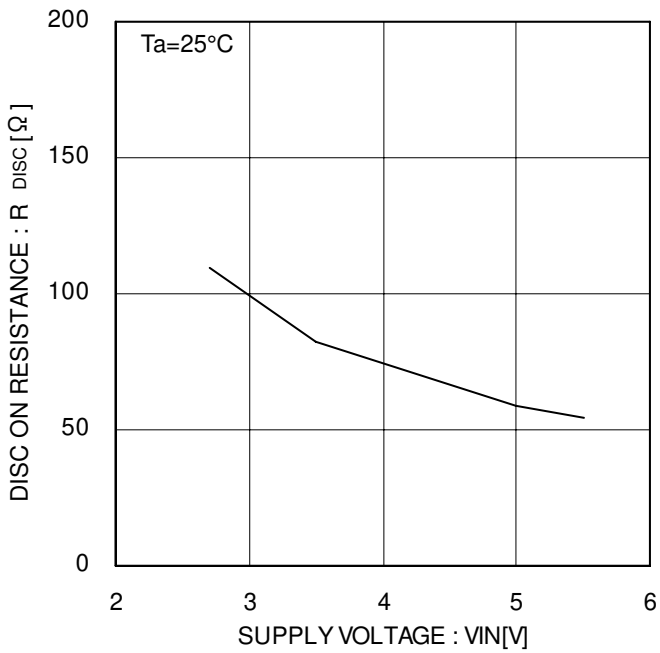

Figure 30. Discharge on resistance

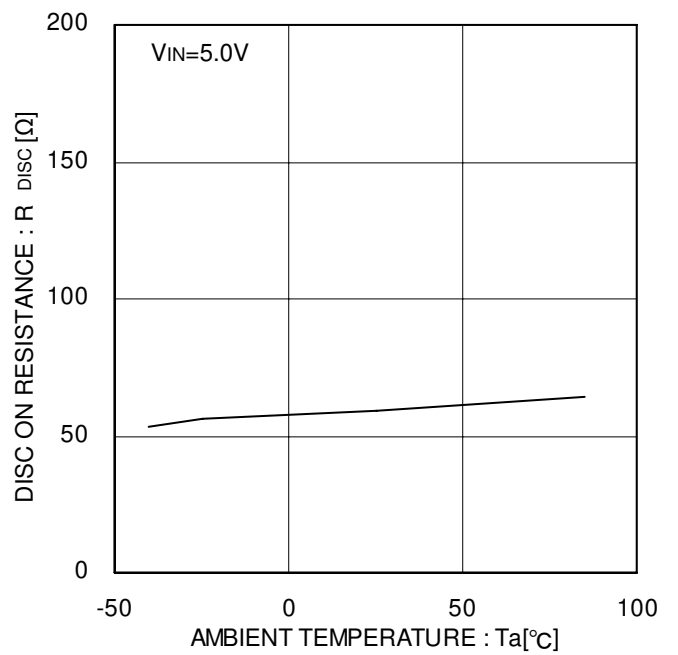

Figure 31. Discharge on resistance

● Typical Wave Forms

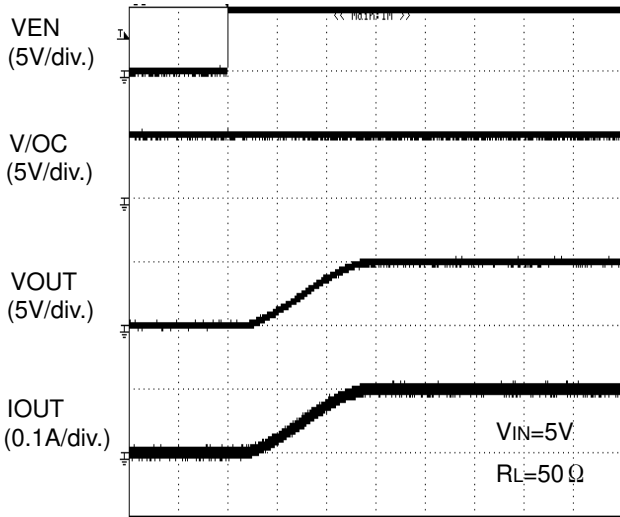

Figure 32. Output rise characteristic

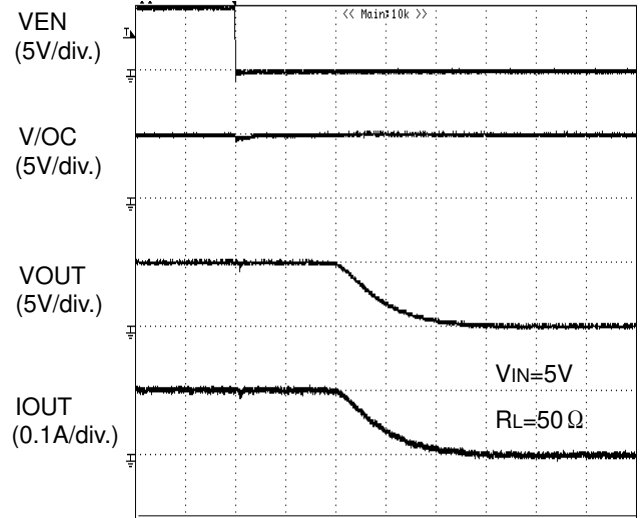

Figure 33. Output fall characteristic

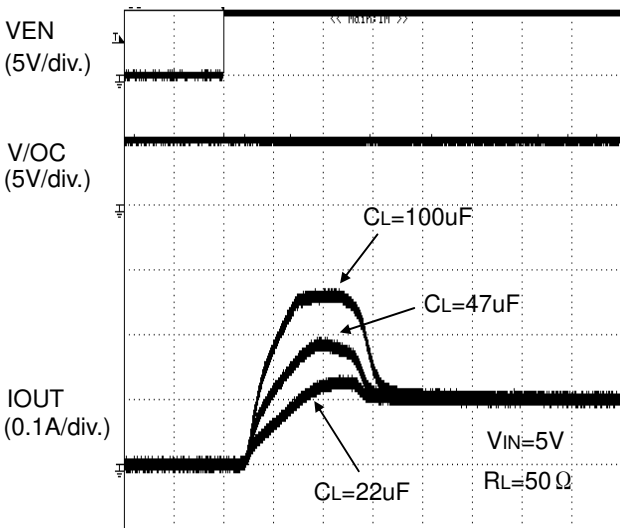

Figure 34. Inrush current response

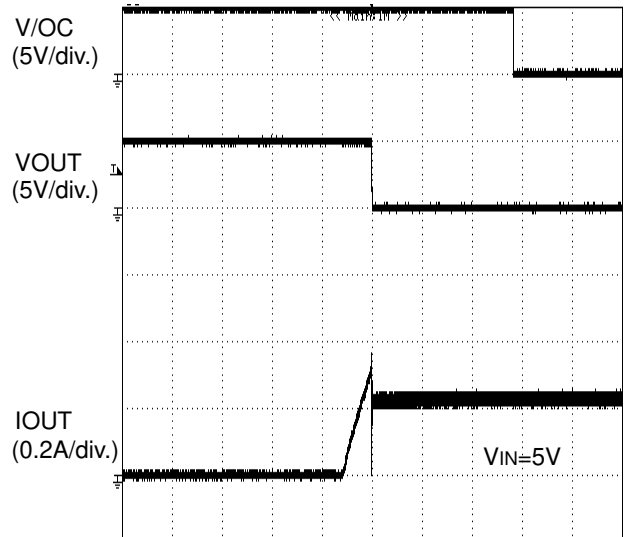
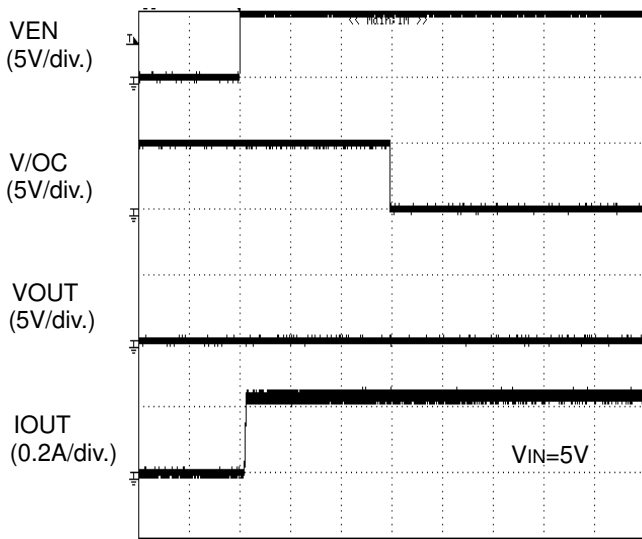
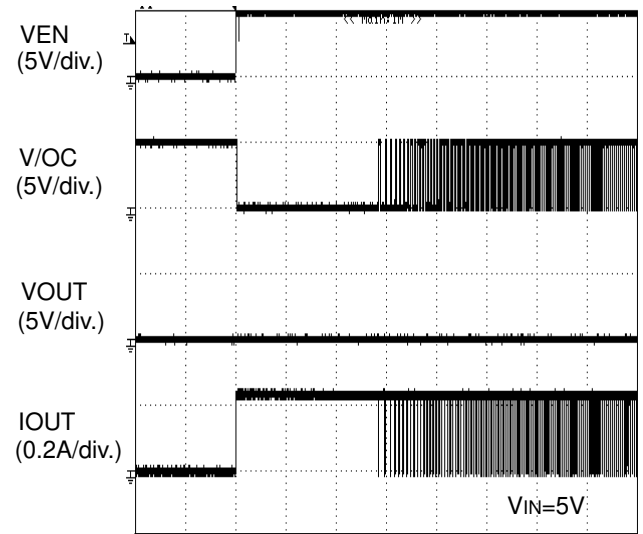

Figure 35. Over-current response ramped load

● Typical Wave Forms - continued



TIME (5ms/div.)  
Figure 36. Over-current response  
enable to shortcircuit



TIME (500ms/div.)  
Figure 37. Over-current response  
enable to shortcircuit

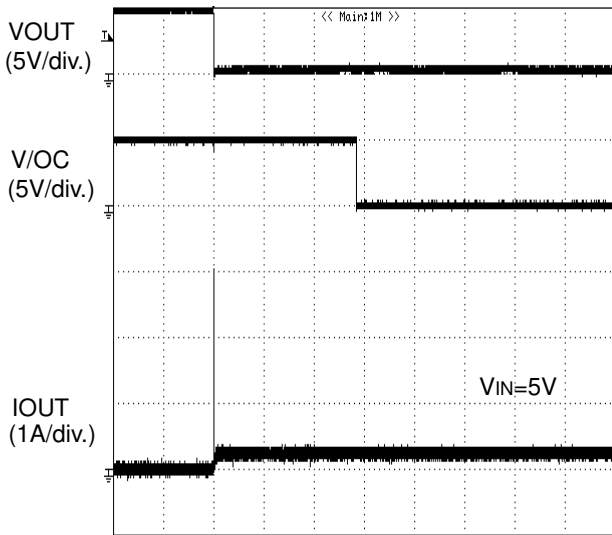

TIME (5ms/div.)  
Figure 38. Over-current response  
1Ω load to enabled device

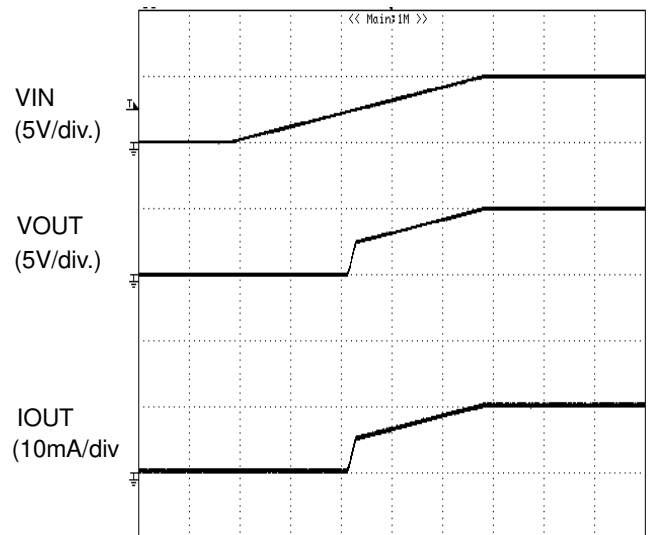

TIME (5ms/div.)  
Figure 39. UVLO response  
increasing VIN

● Typical Wave Forms - continued

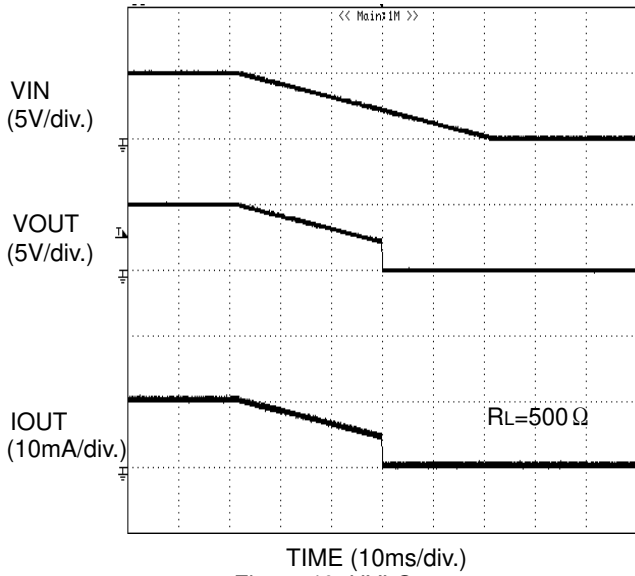

Figure 40. UVLO response decreasing VIN

## ● Typical Application Circuit

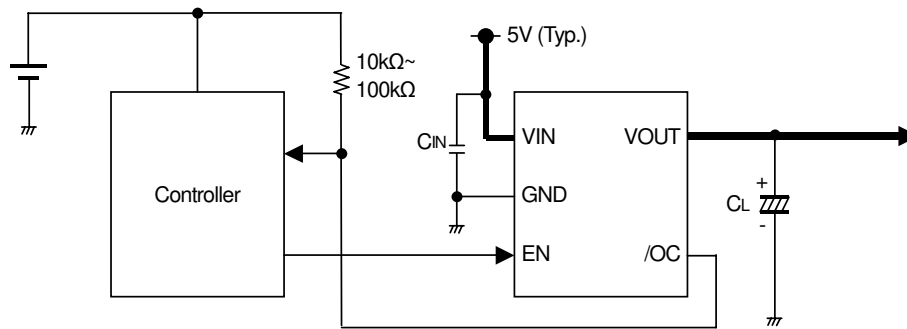

Figure 41. Typical application circuit

## ● Application Information

When excessive current flows owing to output shortcircuit or so, ringing occurs by inductance of power source line to IC, and may cause bad influences upon IC actions. In order to avoid this case, connect a bypass capacitor  $C_{IN}$  by VIN terminal and GND terminal of IC. 1 $\mu$ F or higher is recommended. In order to decrease voltage fluctuations of power source line to IC, connect a low ESR capacitor in parallel with  $C_{IN}$ . 10 $\mu$ F to 100 $\mu$ F or higher is effective.

Pull up /OC output by resistance 10k $\Omega$  to 100k $\Omega$ .

Set up value, which satisfies the application as  $C_L$ .

This system connection diagram doesn't guarantee operating as the application.

When using the circuit with changes to the external circuit constants, make sure to leave an adequate margin for external components including static and transitional characteristics as well as dispersion of the IC.

## ● Functional Description

### 1. Switch Operation

VIN terminal and VOUT terminal are connected to the drain and the source of switch MOSFET respectively. And the VIN terminal is used also as power source input to internal control circuit.

When the switch is turned on from EN control input, VIN terminal and VOUT terminal are connected by an 110m $\Omega$ (Typ.) switch. In on status, the switch is bidirectional. Therefore, when the potential of VOUT terminal is higher than that of VIN terminal, current flows from VOUT terminal to VIN terminal.

Since a parasitic diode between the drain and the source of switch MOSFET is canceled, in the off status, it is possible to prevent current from flowing reversely from VOUT to VIN.

### 2. Thermal Shutdown Circuit (TSD)

If over-current would continue, the temperature of the IC would increase drastically. If the junction temperature were beyond 135 $^{\circ}$ C(Typ.) in the condition of over-current detection, thermal shutdown circuit operates and makes power switch turn off and outputs fault flag (/OC). Then, when the junction temperature decreases lower than 115 $^{\circ}$ C(Typ.), power switch is turned on and fault flag (/OC) is cancelled. Unless the fact of the increasing chips temperature is removed or the output of power switch is turned off, this operation repeats.

The thermal shutdown circuit operates when the switch is on (EN signal is active).

### 3. Over-Current Detection (OCD)

The over-current detection circuit limits current ( $I_{SC}$ ) and outputs fault flag (/OC) when current flowing in each switch MOSFET exceeds a specified value. There are three types of response against over-current. The over-current detection circuit works when the switch is on (EN signal is active).

#### 3-1. When the switch is turned on while the output is in shortcircuit status

When the switch is turned on while the output is in shortcircuit status or so, the switch gets in current limit status soon.

3-2. When the output shortcircuits while the switch is on

When the output shortcircuits or large capacity is connected while the switch is on, very large current flows until the over-current limit circuit reacts. When the current detection, limit circuit works, current limitation is carried out.

3-3. When the output current increases gradually

When the output current increases gradually, current limitation does not work until the output current exceeds the over-current detection value. When it exceeds the detection value, current limitation is carried out.

4. Under-Voltage Lockout (UVLO)

UVLO circuit prevents the switch from turning on until the VIN exceeds 2.3V(Typ.). If the VIN drops below 2.2V(Typ.) while the switch turns on, then UVLO shuts off the power switch. UVLO has hysteresis of a 100mV(Typ). Under-voltage lockout circuit works when the switch is on (EN signal is active).

5. Fault Flag (/OC) Output

Fault flag output is N-MOS open drain output. At detection of over-current, thermal shutdown, low level is output.

Over-current detection has delay filter. This delay filter prevents instantaneous current detection such as inrush current at switch on, hot plug from being informed to outside.

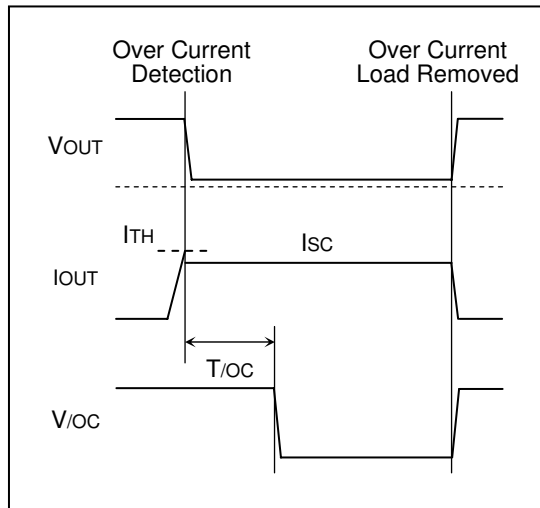

Figure 42. Over-current detection

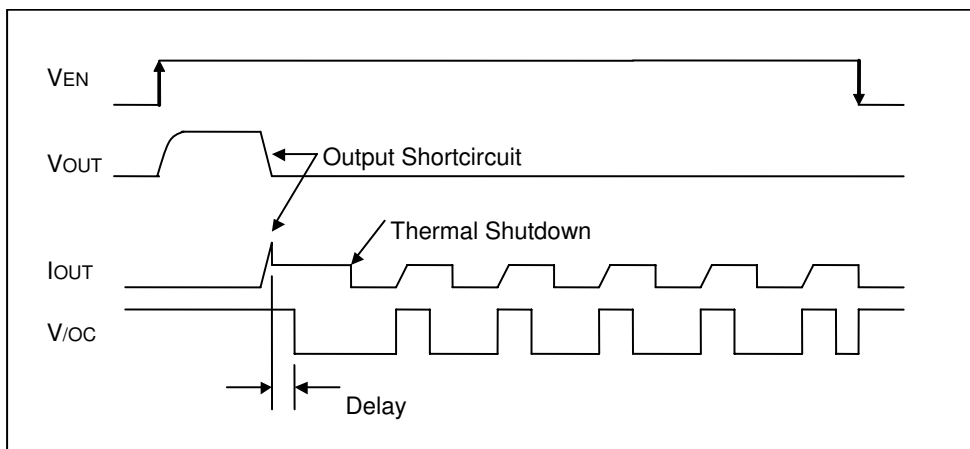
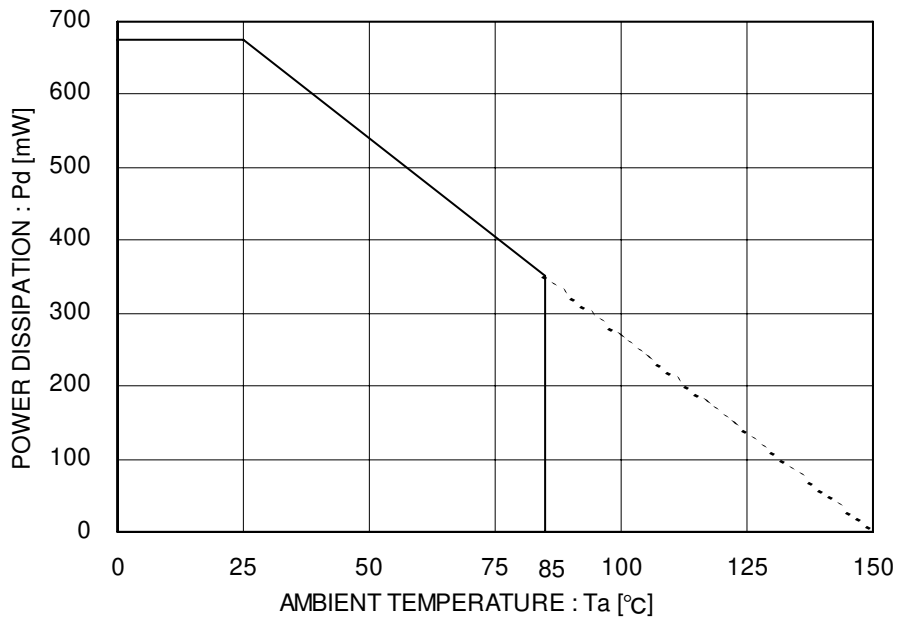

Figure 43. Over-current detection, Thermal shutdown timing



●Power Dissipation  
(SSOP5 package)



\* 70mm x 70mm x 1.6mm Glass Epoxy Board

Figure 44. Power Dissipation Curve (Pd-Ta Curve)

●I/O Equivalence Circuit

Symbol	Pin No.	Equivalent Circuit
EN	3	
VOUT	5	
/OC	4	

## ●Operational Notes

- (1) Absolute maximum ratings  
An excess in the absolute maximum ratings, such as supply voltage, temperature range of operating conditions, etc., can break down devices, thus making impossible to identify breaking mode such as a short circuit or an open circuit. If any special mode exceeding the absolute maximum ratings is assumed, consideration should be given to take physical safety measures including the use of fuses, etc.
- (2) Operating conditions  
These conditions represent a range within which characteristics can be provided approximately as expected. The electrical characteristics are guaranteed under the conditions of each parameter.
- (3) Reverse connection of power supply connector  
The reverse connection of power supply connector can break down ICs. Take protective measures against the breakdown due to the reverse connection, such as mounting an external diode between the power supply and the IC's power supply terminal.
- (4) Power supply line  
Design PCB pattern to provide low impedance for the wiring between the power supply and the GND lines. In this regard, for the digital block power supply and the analog block power supply, even though these power supplies has the same level of potential, separate the power supply pattern for the digital block from that for the analog block, thus suppressing the diffraction of digital noises to the analog block power supply resulting from impedance common to the wiring patterns. For the GND line, give consideration to design the patterns in a similar manner. Furthermore, for all power supply terminals to ICs, mount a capacitor between the power supply and the GND terminal. At the same time, in order to use an electrolytic capacitor, thoroughly check to be sure the characteristics of the capacitor to be used present no problem including the occurrence of capacity dropout at a low temperature, thus determining the constant.
- (5) GND voltage  
Make setting of the potential of the GND terminal so that it will be maintained at the minimum in any operating state. Furthermore, check to be sure no terminals are at a potential lower than the GND voltage including an actual electric transient.
- (6) Short circuit between terminals and erroneous mounting  
In order to mount ICs on a set PCB, pay thorough attention to the direction and offset of the ICs. Erroneous mounting can break down the ICs. Furthermore, if a short circuit occurs due to foreign matters entering between terminals or between the terminal and the power supply or the GND terminal, the ICs can break down.
- (7) Operation in strong electromagnetic field  
Be noted that using ICs in the strong electromagnetic field can malfunction them.
- (8) Inspection with set PCB  
On the inspection with the set PCB, if a capacitor is connected to a low-impedance IC terminal, the IC can suffer stress. Therefore, be sure to discharge from the set PCB by each process. Furthermore, in order to mount or dismount the set PCB to/from the jig for the inspection process, be sure to turn OFF the power supply and then mount the set PCB to the jig. After the completion of the inspection, be sure to turn OFF the power supply and then dismount it from the jig. In addition, for protection against static electricity, establish a ground for the assembly process and pay thorough attention to the transportation and the storage of the set PCB.
- (9) Input terminals  
In terms of the construction of IC, parasitic elements are inevitably formed in relation to potential. The operation of the parasitic element can cause interference with circuit operation, thus resulting in a malfunction and then breakdown of the input terminal. Therefore, pay thorough attention not to handle the input terminals, such as to apply to the input terminals a voltage lower than the GND respectively, so that any parasitic element will operate. Furthermore, do not apply a voltage to the input terminals when no power supply voltage is applied to the IC. In addition, even if the power supply voltage is applied, apply to the input terminals a voltage lower than the power supply voltage or within the guaranteed value of electrical characteristics.
- (10) Ground wiring pattern  
If small-signal GND and large-current GND are provided, It will be recommended to separate the large-current GND pattern from the small-signal GND pattern and establish a single ground at the reference point of the set PCB so that resistance to the wiring pattern and voltage fluctuations due to a large current will cause no fluctuations in voltages of the small-signal GND. Pay attention not to cause fluctuations in the GND wiring pattern of external parts as well.
- (11) External capacitor  
In order to use a ceramic capacitor as the external capacitor, determine the constant with consideration given to a degradation in the nominal capacitance due to DC bias and changes in the capacitance due to temperature, etc.
- (12) Thermal shutdown circuit (TSD)  
When junction temperatures become detected temperatures or higher, the thermal shutdown circuit operates and turns a switch OFF. The thermal shutdown circuit is aimed at isolating the LSI from thermal runaway as much as possible. Do not continuously use the LSI with this circuit operating or use the LSI assuming its operation.
- (13) Thermal design  
Perform thermal design in which there are adequate margins by taking into account the power dissipation (Pd) in actual states of use.

●Ordering Information

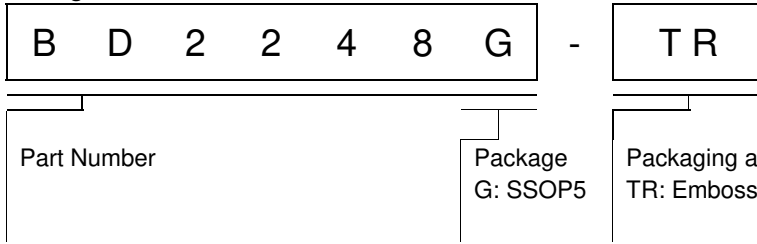

●Physical Dimension Tape and Reel Information

SSOP5

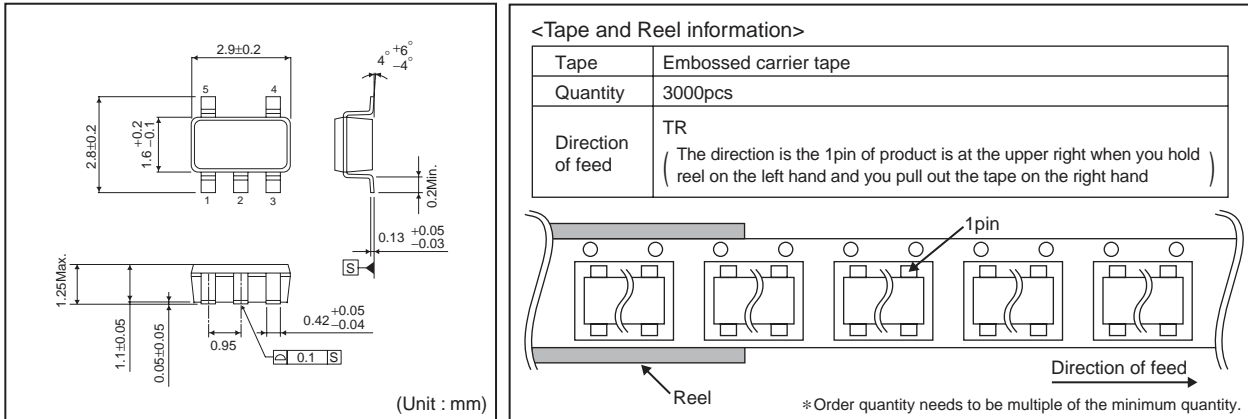

●Marking Diagram

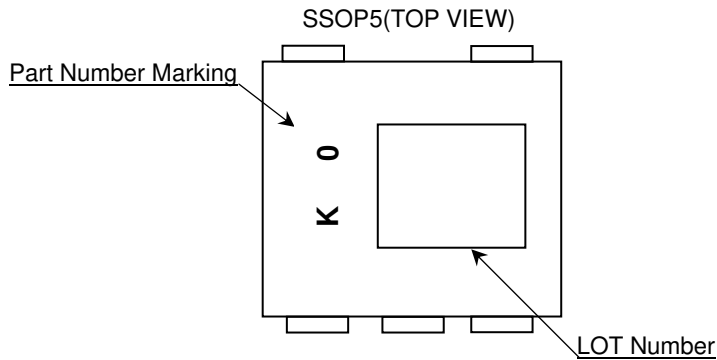

Status of this document

The Japanese version of this document is formal specification. A customer may use this translation version only for a reference to help reading the formal version.

If there are any differences in translation version of this document formal version takes priority.

## ●Revision History

Date	Revision	Changes
25.JUL.2012	001	New Release

# Notice

## Precaution on using ROHM Products

- Our Products are designed and manufactured for application in ordinary electronic equipments (such as AV equipment, OA equipment, telecommunication equipment, home electronic appliances, amusement equipment, etc.). If you intend to use our Products in devices requiring extremely high reliability (such as medical equipment <sup>(Note 1)</sup>, transport equipment, traffic equipment, aircraft/spacecraft, nuclear power controllers, fuel controllers, car equipment including car accessories, safety devices, etc.) and whose malfunction or failure may cause loss of human life, bodily injury or serious damage to property ("Specific Applications"), please consult with the ROHM sales representative in advance. Unless otherwise agreed in writing by ROHM in advance, ROHM shall not be in any way responsible or liable for any damages, expenses or losses incurred by you or third parties arising from the use of any ROHM's Products for Specific Applications.

(Note1) Medical Equipment Classification of the Specific Applications

JAPAN	USA	EU	CHINA
CLASS III	CLASS III	CLASS II b	CLASS III
CLASS IV		CLASS III	

- ROHM designs and manufactures its Products subject to strict quality control system. However, semiconductor products can fail or malfunction at a certain rate. Please be sure to implement, at your own responsibilities, adequate safety measures including but not limited to fail-safe design against the physical injury, damage to any property, which a failure or malfunction of our Products may cause. The following are examples of safety measures:
  - Installation of protection circuits or other protective devices to improve system safety
  - Installation of redundant circuits to reduce the impact of single or multiple circuit failure
- Our Products are designed and manufactured for use under standard conditions and not under any special or extraordinary environments or conditions, as exemplified below. Accordingly, ROHM shall not be in any way responsible or liable for any damages, expenses or losses arising from the use of any ROHM's Products under any special or extraordinary environments or conditions. If you intend to use our Products under any special or extraordinary environments or conditions (as exemplified below), your independent verification and confirmation of product performance, reliability, etc. prior to use, must be necessary:
  - Use of our Products in any types of liquid, including water, oils, chemicals, and organic solvents
  - Use of our Products outdoors or in places where the Products are exposed to direct sunlight or dust
  - Use of our Products in places where the Products are exposed to sea wind or corrosive gases, including Cl<sub>2</sub>, H<sub>2</sub>S, NH<sub>3</sub>, SO<sub>2</sub>, and NO<sub>2</sub>
  - Use of our Products in places where the Products are exposed to static electricity or electromagnetic waves
  - Use of our Products in proximity to heat-producing components, plastic cords, or other flammable items
  - Sealing or coating our Products with resin or other coating materials
  - Use of our Products without cleaning residue of flux (even if you use no-clean type fluxes, cleaning residue of flux is recommended); or Washing our Products by using water or water-soluble cleaning agents for cleaning residue after soldering
  - Use of the Products in places subject to dew condensation
- The Products are not subject to radiation-proof design.
- Please verify and confirm characteristics of the final or mounted products in using the Products.
- In particular, if a transient load (a large amount of load applied in a short period of time, such as pulse. is applied, confirmation of performance characteristics after on-board mounting is strongly recommended. Avoid applying power exceeding normal rated power; exceeding the power rating under steady-state loading condition may negatively affect product performance and reliability.
- De-rate Power Dissipation (Pd) depending on Ambient temperature (Ta). When used in sealed area, confirm the actual ambient temperature.
- Confirm that operation temperature is within the specified range described in the product specification.
- ROHM shall not be in any way responsible or liable for failure induced under deviant condition from what is defined in this document.

## Precaution for Mounting / Circuit board design

- When a highly active halogenous (chlorine, bromine, etc.) flux is used, the residue of flux may negatively affect product performance and reliability.
- In principle, the reflow soldering method must be used; if flow soldering method is preferred, please consult with the ROHM representative in advance.

For details, please refer to ROHM Mounting specification

**Precautions Regarding Application Examples and External Circuits**

1. If change is made to the constant of an external circuit, please allow a sufficient margin considering variations of the characteristics of the Products and external components, including transient characteristics, as well as static characteristics.
2. You agree that application notes, reference designs, and associated data and information contained in this document are presented only as guidance for Products use. Therefore, in case you use such information, you are solely responsible for it and you must exercise your own independent verification and judgment in the use of such information contained in this document. ROHM shall not be in any way responsible or liable for any damages, expenses or losses incurred by you or third parties arising from the use of such information.

**Precaution for Electrostatic**

This Product is electrostatic sensitive product, which may be damaged due to electrostatic discharge. Please take proper caution in your manufacturing process and storage so that voltage exceeding the Products maximum rating will not be applied to Products. Please take special care under dry condition (e.g. Grounding of human body / equipment / solder iron, isolation from charged objects, setting of Ionizer, friction prevention and temperature / humidity control).

**Precaution for Storage / Transportation**

1. Product performance and soldered connections may deteriorate if the Products are stored in the places where:
  - [a] the Products are exposed to sea winds or corrosive gases, including Cl<sub>2</sub>, H<sub>2</sub>S, NH<sub>3</sub>, SO<sub>2</sub>, and NO<sub>2</sub>
  - [b] the temperature or humidity exceeds those recommended by ROHM
  - [c] the Products are exposed to direct sunshine or condensation
  - [d] the Products are exposed to high Electrostatic
2. Even under ROHM recommended storage condition, solderability of products out of recommended storage time period may be degraded. It is strongly recommended to confirm solderability before using Products of which storage time is exceeding the recommended storage time period.
3. Store / transport cartons in the correct direction, which is indicated on a carton with a symbol. Otherwise bent leads may occur due to excessive stress applied when dropping of a carton.
4. Use Products within the specified time after opening a humidity barrier bag. Baking is required before using Products of which storage time is exceeding the recommended storage time period.

**Precaution for Product Label**

QR code printed on ROHM Products label is for ROHM's internal use only.

**Precaution for Disposition**

When disposing Products please dispose them properly using an authorized industry waste company.

**Precaution for Foreign Exchange and Foreign Trade act**

Since our Products might fall under controlled goods prescribed by the applicable foreign exchange and foreign trade act, please consult with ROHM representative in case of export.

**Precaution Regarding Intellectual Property Rights**

1. All information and data including but not limited to application example contained in this document is for reference only. ROHM does not warrant that foregoing information or data will not infringe any intellectual property rights or any other rights of any third party regarding such information or data. ROHM shall not be in any way responsible or liable for infringement of any intellectual property rights or other damages arising from use of such information or data.:
2. No license, expressly or implied, is granted hereby under any intellectual property rights or other rights of ROHM or any third parties with respect to the information contained in this document.

**Other Precaution**

1. This document may not be reprinted or reproduced, in whole or in part, without prior written consent of ROHM.
2. The Products may not be disassembled, converted, modified, reproduced or otherwise changed without prior written consent of ROHM.
3. In no event shall you use in any way whatsoever the Products and the related technical information contained in the Products or this document for any military purposes, including but not limited to, the development of mass-destruction weapons.
4. The proper names of companies or products described in this document are trademarks or registered trademarks of ROHM, its affiliated companies or third parties.

### General Precaution

1. Before you use our Products, you are requested to carefully read this document and fully understand its contents. ROHM shall not be in any way responsible or liable for failure, malfunction or accident arising from the use of any ROHM's Products against warning, caution or note contained in this document.
2. All information contained in this document is current as of the issuing date and subject to change without any prior notice. Before purchasing or using ROHM's Products, please confirm the latest information with a ROHM sales representative.
3. The information contained in this document is provided on an "as is" basis and ROHM does not warrant that all information contained in this document is accurate and/or error-free. ROHM shall not be in any way responsible or liable for any damages, expenses or losses incurred by you or third parties resulting from inaccuracy or errors of or concerning such information.