

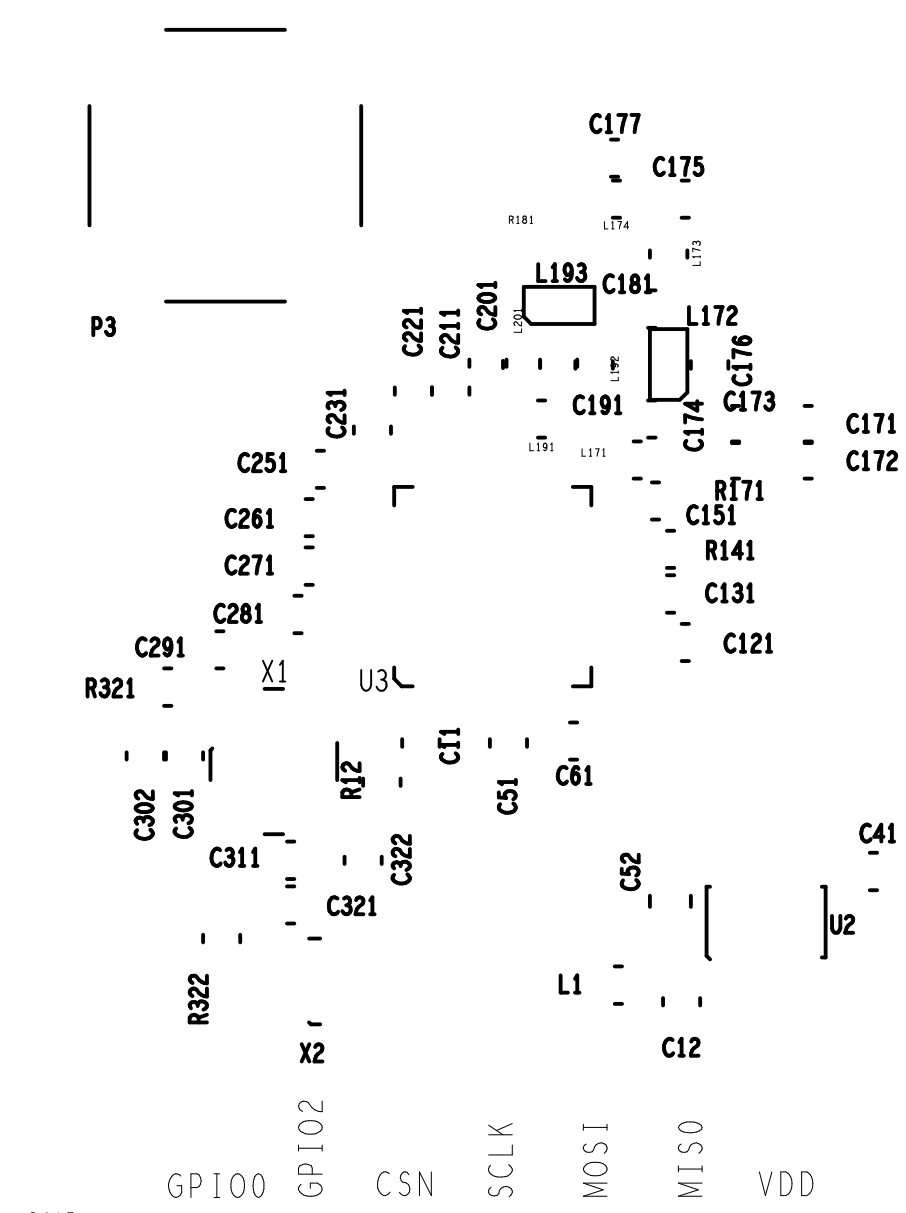

CC120xEM 420-470MHz Rev 1.1

A1 ANT3 ANT2 ANT1

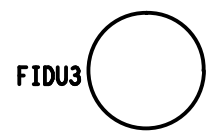
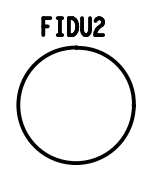

GND GPIO0 GPIO2 CSN SCLK MOSI MISO VDD P4

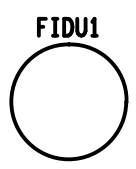

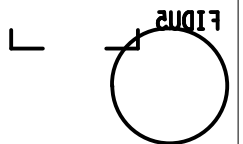
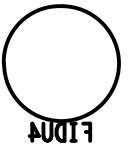
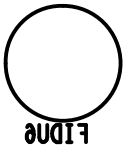

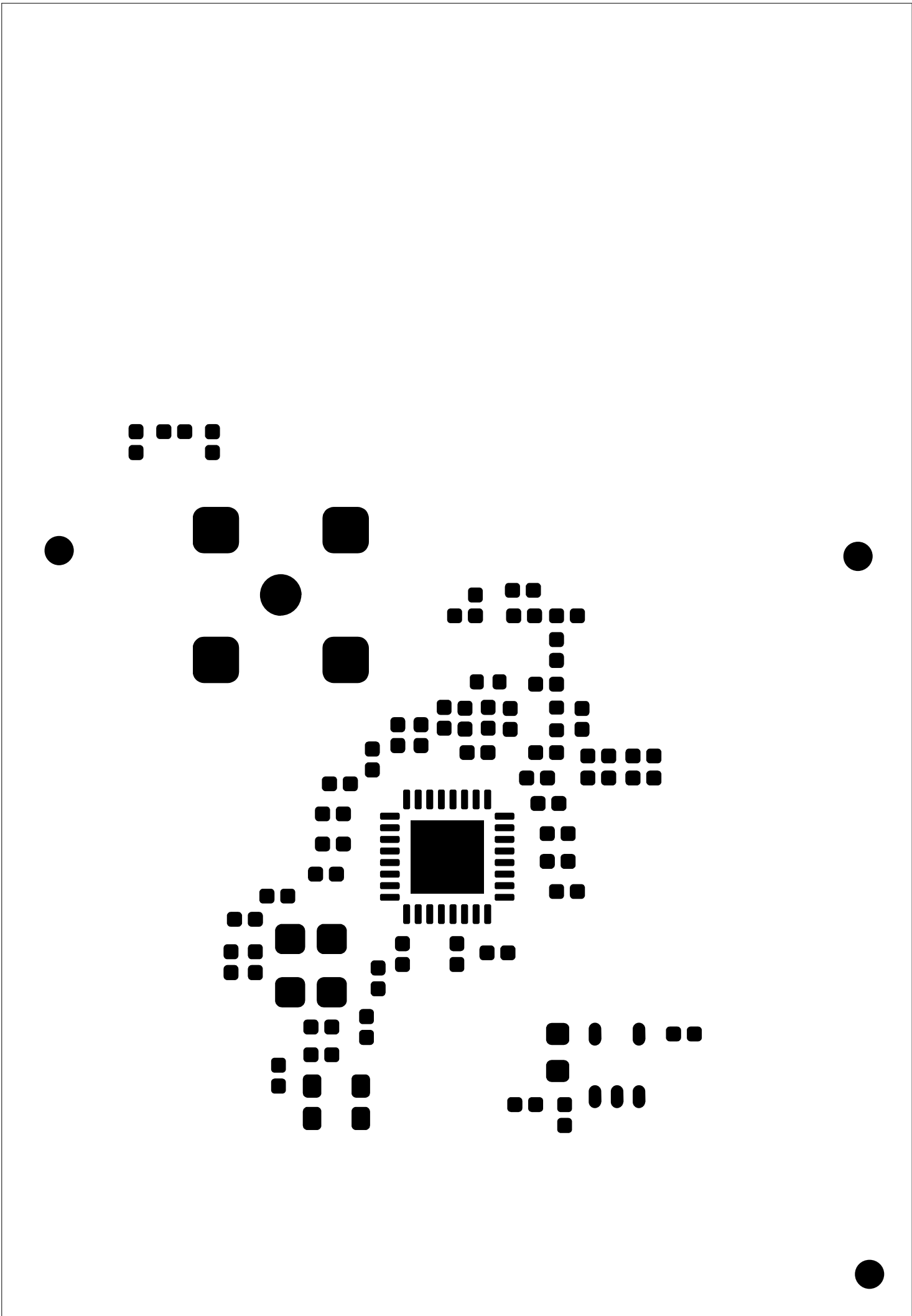

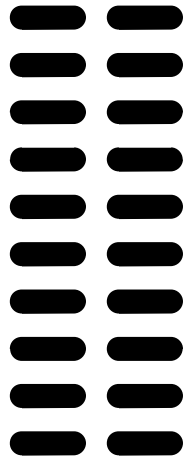
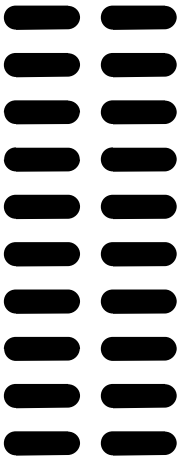

CC120xEM 420-470MHz Rev 1.1

A1

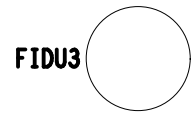
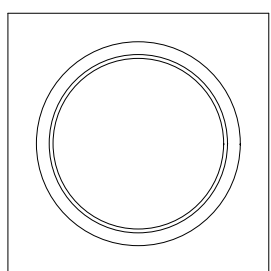
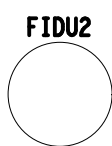

P3

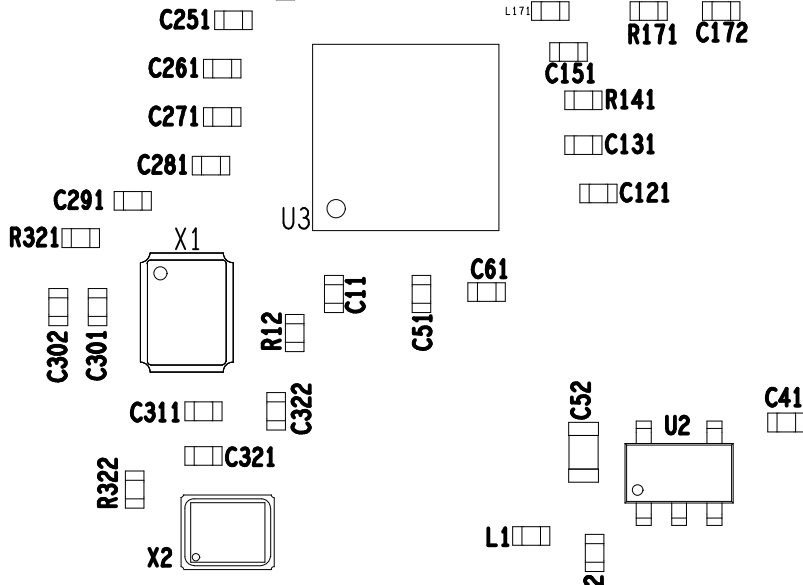

P4

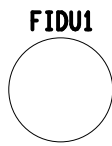

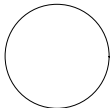
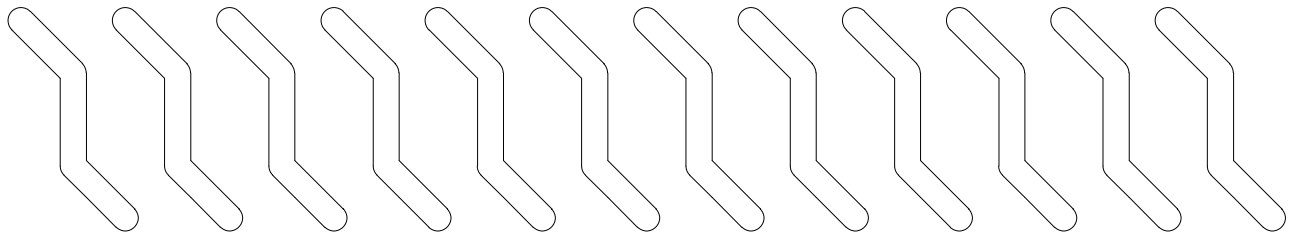

FIDU#

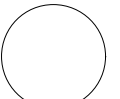

FIDU#

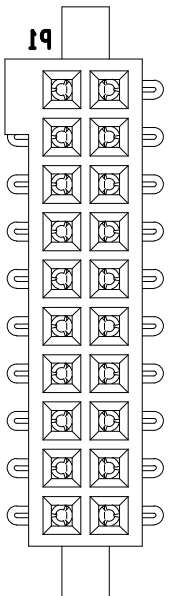

p1

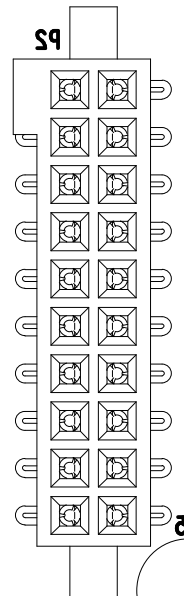

p5

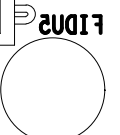

FIDU#

