

Evaluation Board for **SSM3302** 2 × 10 W Filterless Class-D Stereo Audio Amplifier

PACKAGE CONTENTS

EVAL-SSM3302Z evaluation board

OTHER SUPPORTING DOCUMENTATION

[SSM3302 data sheet](#)

GENERAL DESCRIPTION

The **SSM3302** is a fully integrated, high efficiency, stereo Class-D audio amplifier. The application circuit requires a minimum of external components and operates from a single 7 V to 18 V supply. It is capable of delivering 2 × 8 W of continuous output power into an 8 Ω load (or 2 × 10 W into 4 Ω) with <1% total harmonic distortion plus noise (THD + N) from a 12 V supply. In addition, while mono mode is active, a load as small as 2 Ω up to 20 W continuous output power can be driven by stacking the stereo output terminals.

Spread spectrum pulse density modulation is used to provide lower EMI-radiated emissions compared with other Class-D architectures. The **SSM3302** includes an optional modulation select pin (ultralow EMI emission mode) that significantly reduces the radiated emissions at the Class-D outputs, particularly above 100 MHz. The **SSM3302** can pass FCC Class-B emissions testing with an unshielded 20 inch cable using common-mode choke-based filtering.

The fully differential input of the **SSM3302** provides excellent rejection of common-mode noise on the input. The device also includes a highly flexible gain select pin that only requires one series resistor to choose any of the five gain options between 9 dB and 24 dB, with no change to the input impedance. The benefit of this is to improve gain matching between multiple **SSM3302** devices within a single application compared to using external resistors to set gain.

This user guide describes how to configure and use the **SSM3302** evaluation board. This user guide should be read in conjunction with the **SSM3302** data sheet, which provides specifications, internal block diagrams, and application guidance for the amplifier IC.

EVALUATION BOARD OVERVIEW

The **SSM3302** evaluation board carries a complete circuit for driving a pair of loudspeakers. Figure 1 shows the top view of the evaluation board, and Figure 2 shows the bottom view of the evaluation board.

EVALUATION BOARD TOP VIEW AND BOTTOM VIEW



Figure 1. **SSM3302** Evaluation Board Top View



Figure 2. **SSM3302** Evaluation Board Bottom View

TABLE OF CONTENTS

Package Contents.....	1	Power Supply Configuration	3
Other Supporting Documentation.....	1	Analog Supply.....	3
General Description	1	Edge Mode.....	4
Evaluation Board Overview	1	Mono Mode.....	4
Evaluation Board Top View and Bottom View.....	1	Component Selection	4
Revision History	2	Intital Evaluation Board Setup.....	5
Setting Up the Evaluation Board	3	Suggested System Level and Audio Tests	5
Input Configuration	3	Evaluation Board Schematic and Artwork.....	6
Shutdown Mode.....	3	Ordering Information.....	8
Gain Configuration	3	Bill of Materials.....	8
Output Configuration.....	3		

REVISION HISTORY

2/12—Revision 0: Initial Version

SETTING UP THE EVALUATION BOARD

INPUT CONFIGURATION

On the bottom center of the PCB are four 2-pin headers, H3 to H6. These are used to connect the input audio signals to the amplifier.

If the input audio signals are differential, use the two center pins of H3 and H4 (INL+ and INL-) for left channel audio and the two center pins of H5 and H6 (INR+ and INR-) for the right channel audio. In this case, connect either the top or the bottom pin to the source/signal ground.

For single-ended audio inputs, the input lines are connected only to the pins of H3 (INL+ and GND) and H5 (INR+ and GND). Jumpers are placed in H4 and H6, shorting INL- and INR- to ground.

Alternatively, single-ended stereo audio may be supplied by connecting a standard 1/8 inch stereo plug to the J7 input instead of connecting it to H3 and H5.

SHUTDOWN MODE

The 3-pin headers, H9 and H12, are used to tie $\overline{\text{SDNL}}$ and $\overline{\text{SDNR}}$ to either GND or AVDD, to enable or disable the left and right channels of the *SSM3302* amplifier. Placing a jumper between the center pin and AVDD puts the *SSM3302* in normal operation. Placing the jumper between the center pin and GND shuts down the *SSM3302* so that only a minimum current (about 10 μA) is drawn from the power supply.

GAIN CONFIGURATION

Two headers, H2 and JP6, control the *SSM3302* analog gain. By placing a jumper across the two pins of H2, the GAIN pin of the amplifier can be connected to GND or AVDD. Three jumper settings are used: between the center pin and the top pin (AVDD), between the center pin and the bottom pin (GND), and no jumper (open).

A 47 k Ω resistor, R18, is inserted between the GAIN pin and the H2 jumper. Placing a jumper on JP6 shorts across this resistor (R18), allowing two extra gain levels.

Gain settings between 9 dB and 24 dB are available. See Table 1 for the gain configuration details.

Table 1. Gain Configuration

Gain (dB)	JP6	H2	Configuration
9	Short	GND	Short GAIN pin to GND
12	Open	GND	GAIN pin through 47 k Ω to GND
15	Open	Open	GAIN pin unconnected
18	Open	AVDD	GAIN pin through 47 k Ω to AVDD
24	Short	AVDD	Short GAIN pin to AVDD

OUTPUT CONFIGURATION

The output terminals, J3 to J6, provide convenient attachment points for speakers or other load devices with standard banana connectors. In addition, 2-pin, 0.100 inch headers are provided. Because the *SSM3302* does not typically require any external audio band LC output filtering due to a low noise modulation scheme, a low cost, high performance, common-mode choke-based filter is installed on the evaluation board for EMI suppression. For optimal performance measurement, remove this filtering by inserting 0 Ω links or a thick wire short across L1 and L2. In this case, leave the filter capacitors, C16 to C18 and C26 to C28, unpopulated.

To safeguard against system radiated emission failure, especially if the speaker cable length exceeds 20 cm, it may be necessary to include an output filter. The recommended filter uses common-mode chokes, L1 and L2, in the output paths, plus capacitors, C16 to C18 and C26 to C28, to couple the output terminals to ground. A schematic of this configuration is shown in Figure 4, with recommended values for the filter components given. The recommended common-mode chokes are listed in Table 2.

Alternatively, inductors may be used instead of common-mode chokes; however, the distortion performance is slightly worse at high power. If inductors are used, they must be used in pairs, with two inductors replacing each common-mode choke. A summary of the recommended inductors is shown in Table 3.

For optimal total harmonic distortion (THD) and signal-to-noise ratio (SNR) performance as specified in the *SSM3302* data sheet, remove the output filters and short across L1 and L2.

POWER SUPPLY CONFIGURATION

The banana jacks, J1 and J2, are used to power the board. Care must be taken to connect the dc power with correct polarity and voltage. Reverse polarity or overvoltage may damage the board permanently. Permissible supply voltages range from 7 V to 18 V; higher voltages may damage the amplifier.

ANALOG SUPPLY

In addition to the 7 V to 18 V power supply, a 5 V analog supply (AVDD) must be present to power the input stage and modulator. The *SSM3302* amplifier has an internal regulator to provide a clean 5 V rail for this purpose; alternatively, an external supply can be used.

When the REGEN pin is pulled high (between 1.35 V and 5.5 V), the internal regulator is enabled, and the chip begins to operate. If the REGEN pin is pulled low, the regulator is enabled, and an external supply must be connected to H1. Do not connect the REGEN pin directly to PVDD, because this will damage the regulator.

On the *SSM3302* evaluation board, the voltage drop from the power indicator LED, D2, is used to provide the logic high level for REGEN. To enable the regulator, tie the center pin of JP3 to the upper pin, V_LED. To disable the regulator, tie it to GND.

EDGE MODE

To reduce the EMI emissions emitted by the [SSM3302](#) amplifier at the cost of slightly lower peak efficiency, an edge rate control mode is available. To enable the reduced-EMI mode, place a jumper on H10 between EDGE and AVDD. To return to the ordinary (fast-edge) operating mode, place the jumper between EDGE and GND.

MONO MODE

If larger output power is needed, the [SSM3302](#) may be configured as a mono amplifier. This configuration allows both output stages to be connected in parallel, allowing for larger currents and, thus, smaller load impedances. In this configuration, the amplifier can drive loads as small as 2 Ω with a maximum output power of 20 W without the need for a heat sink.

In mono mode, the amplifier uses only the audio signal connected to the left channel input. To minimize distortion and other undesired effects, it is important to minimize the cable length between the output stages. The recommended configuration is as follows: connect the load to the OUTL+ and OUTL− terminals, and use heavy gage wire to short between the terminals of L1 and L2 as shown in Figure 3, instead of connecting the two channels at the output banana terminals.

To configure the amplifier for mono mode, use a jumper on H11 to connect the center pin to AVDD. To operate in stereo mode, connect the center pin to GND.



Figure 3. Board Modifications for Mono Mode

COMPONENT SELECTION

Selecting the proper components is the key to achieving the performance required at the budgeted cost.

Input Coupling Capacitor Selection—C1 and C2

The input coupling capacitors, C1 and C2, should be large enough to couple the low frequency signal components in the incoming signal; however, small enough to reject unnecessary extremely low frequency signals. For music signals, the cutoff frequency is typically between 20 Hz and 30 Hz. The value of the input capacitor is calculated by

$$C = 1/(2\pi \times 40 \text{ k}\Omega \times f_c)$$

where f_c is the desired cutoff frequency.

Common Mode Choke Coils—L1 and L2

The common-mode choke coils, L1 and L2, are necessary components for filtering out the EMI caused at the switching output nodes when the length of the speaker wire is greater than 20 cm. Recommended components are shown in Table 2.

Output Shunting Capacitors

There are six output shunting capacitors, C16 to C18 and C26 to C28, that work with the common-mode chokes coils, L1 and L2. Use small size (0603 or 0402), multilayer ceramic capacitors made of X7R or C0G (NP0) materials. The recommended value is 1000 pF.

Output Inductors

If inductors are preferred for EMI filtering at the output nodes, choose components with an inductance of less than 2.2 μH. The higher the inductance, the lower the EMI is at the output; however, cost and power consumption are higher. Using 1.0 μH to 2.2 μH inductors is recommended, and the current rating (and saturation current) should exceed 2000 mA for an 8 Ω load. Table 3 shows the recommended inductors.

Table 2. Recommended Common-Mode Chokes

Part No. ¹	Manufacturer	Z (Ω at 100 MHz)	I _{MAX} (mA)	DCR (Ω)	Size (mm)
DLW5BTN251SQ2	Murata Manufacturing Co.	250	5000	0.014	5.0 × 5.0 × 2.35
DLW5BTN101SQ2	Murata Manufacturing Co.	100	6000	0.009	5.0 × 5.0 × 2.35

¹ Contact Murata Manufacturing Co. for further options.

Table 3. Recommended Output Inductors

Part No.	Manufacturer	L (μH)	I _{MAX} (mA)	DCR (Ω)	Size (mm)
VLS252012ET-1R0N	TDK Corporation	1.0	2450	0.087	2.5 × 2.0 × 1.2
BRL3225T1R0M	Taiyo Yuden, Co., Ltd	1.0	2400	0.052	3.2 × 2.5 × 1.7
LQH32PN1R0NN0L	Murata Manufacturing Co.	1.0	2300	0.054	3.2 × 2.5 × 1.55
VLS252012ET-1R5N	TDK Corporation	1.5	2000	0.105	2.5 × 2.0 × 1.2

INITIAL EVALUATION BOARD SETUP

To get the amplifier to work in a simple single-ended stereo configuration for quick evaluation, follow these steps:

1. Ensure that the output filter is installed or 0 Ω links are in place to connect the output terminals to the IC.
2. Place a jumper between the upper two pins of JP3 (on the right, next to the power LED) to enable the internal regulator.
3. In the bottom right corner, place jumpers from SDNL to AVDD, from SDNR to AVDD, and from MONO to GND.
4. Choose a gain setting by following the instructions in the Gain Configuration section.
5. In the bottom left corner, choose an EDGE setting. Verify that H1 does not have a jumper because this would short the internal regulator.
6. Place jumpers on H4 and H6, and connect a stereo audio source to the 1/8 inch jack, J7.
7. Connect speakers to the left and right banana jacks.
8. Connect a power supply to the PVDD and GND banana jacks on the top edge.

SUGGESTED SYSTEM LEVEL AND AUDIO TESTS

Test the following:

- Electromagnetic interference (EMI). Connect wires for the speakers, ensuring that they are the same length as the wires required for the actual application environment, and then complete the EMI test.
- Signal-to-noise ratio.
- Output noise. Ensure that an A-weighted filter is used to filter the output before reading the measurement meter.
- Maximum output power.
- Distortion.
- Efficiency.

EVALUATION BOARD SCHEMATIC AND ARTWORK

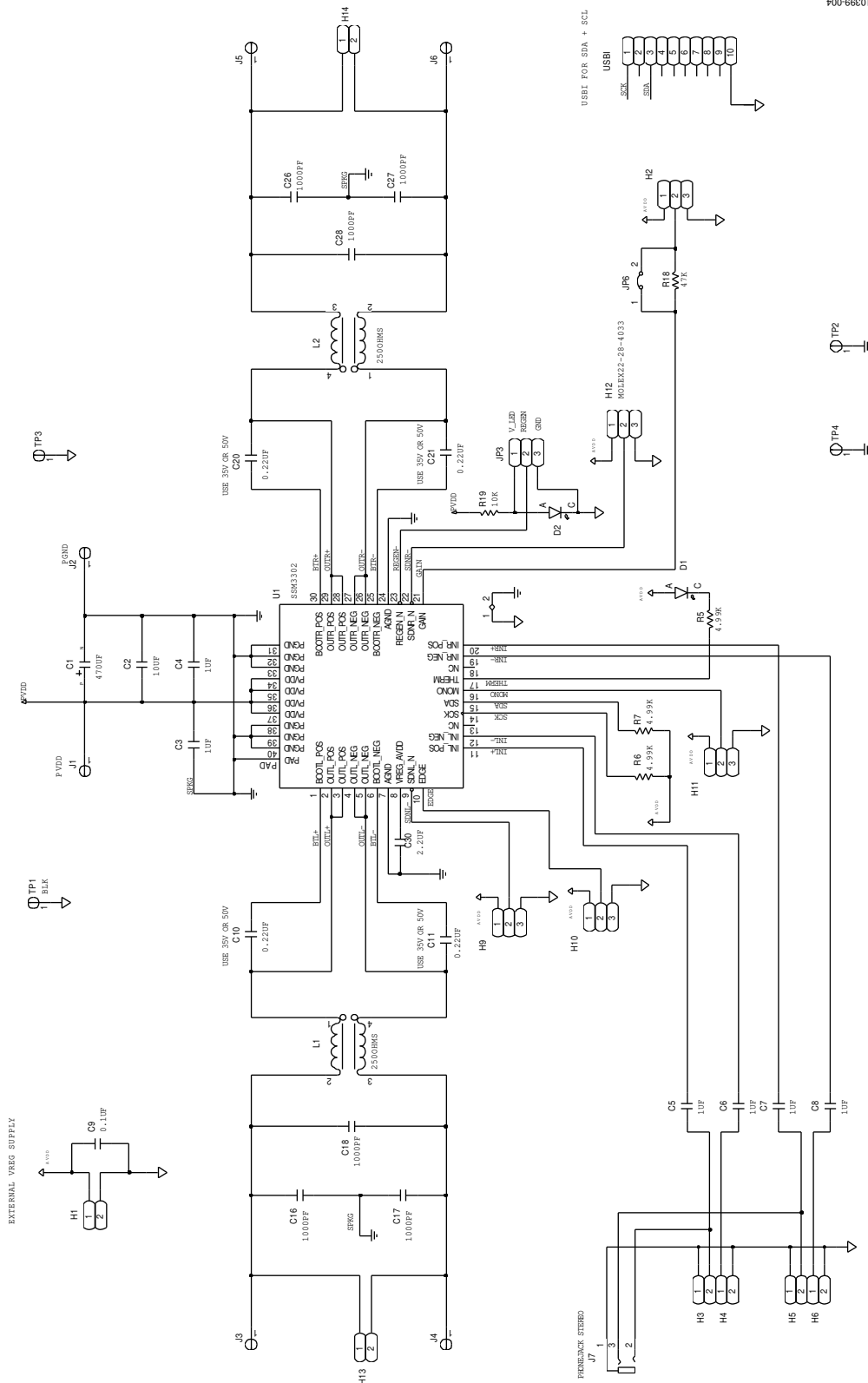

10399-004

Figure 4. Schematic of the SSM3302 Evaluation Board

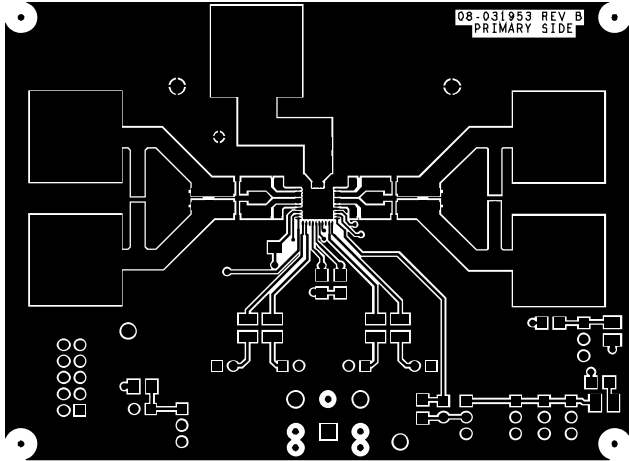

Figure 5. SSM3302 Evaluation Board Top Layer Copper

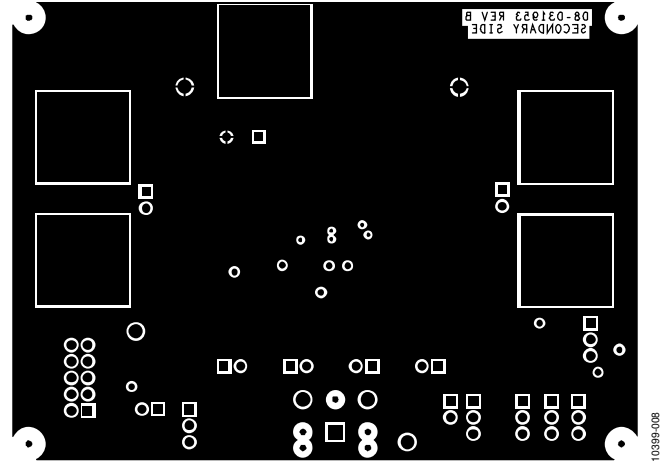

Figure 8. SSM3302 Evaluation Board Bottom Layer Copper

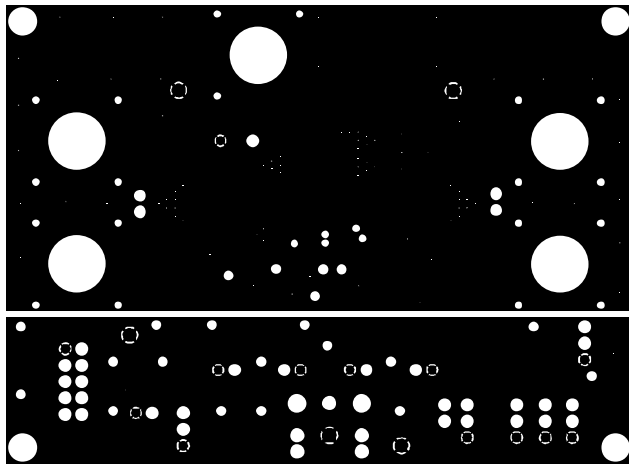

Figure 6. SSM3302 Evaluation Board Second Layer Copper

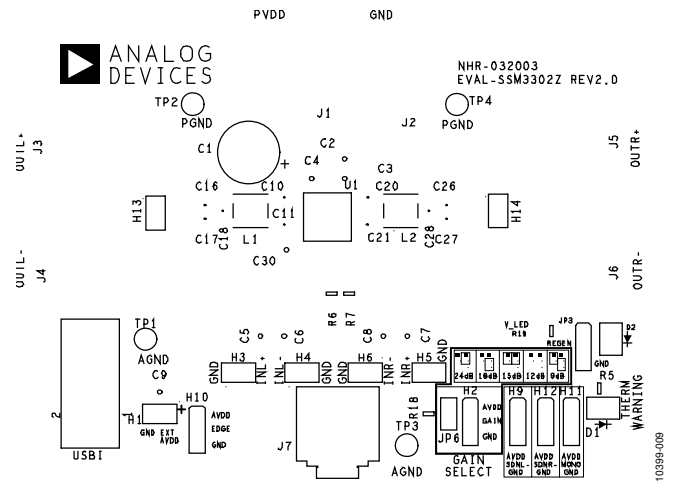

Figure 9. SSM3302 Evaluation Board Top Silkscreen

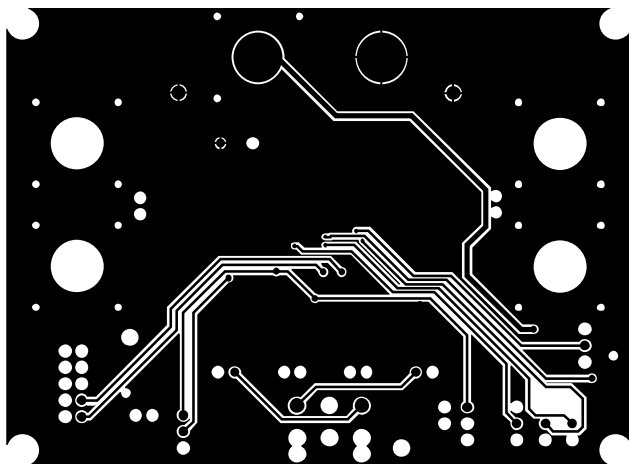

Figure 7. SSM3302 Evaluation Board Third Layer Copper

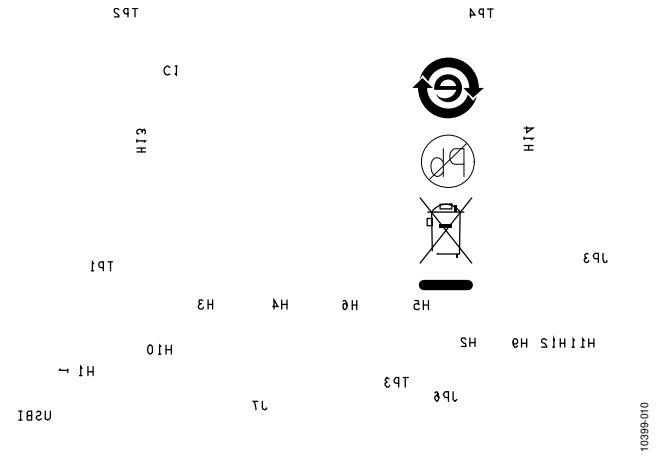

Figure 10. SSM3302 Evaluation Board Bottom Silkscreen

ORDERING INFORMATION

BILL OF MATERIALS

Table 4.

Qty	Reference Designator	Description	Supplier	Part No.
1	C1	Electrolytic, 470 μ F, 16 V	Panasonic	EEUFM1C471
4	C10, C11, C20, C21	Ceramic capacitor, X7R, 0603, 0.22 μ F, 50 V	Murata Manufacturing Co.	GCM188R71H224KA64D
6	C16 to C18, C26 to C28	Ceramic capacitor, X7R, 0603, 1000 pF, 200 V	AVX Corporation	06032C102JAT2A
1	C2	Ceramic capacitor, X5R, 1206, 10 μ F, 25 V	Murata Manufacturing Co.	GRM31CR61E106KA12L
6	C3 to C8	Ceramic capacitor, X7R, 1210, 1 μ F, 50 V	AVX Corporation	12105C105KAT2A
1	C30	Ceramic capacitor, X7R, 1206, 2.2 μ F, 25 V	TDK	C3216X7R1E225K
1	C9	Ceramic capacitor, X7R, 1206, 0.1 μ F, 50 V	Phycomp (Yageo)	CC1206KRX7R9BB104
1	D1	LED yellow surface mount	Chicago Miniature Lighting, LCC	CMD67-21UYC/TR8
1	D2	LED blue surface mount	Chicago Miniature Lighting, LCC	CMD67-21UBC/TR8
8	H1, H3 to H6, H13, H14, JP6	Breakaway header	Tyco Electronics	9-146285-0-02
6	H2, H9 to H12, JP3	3-position PCB header	Molex	22-28-4033
6	J1 to J6	Banana jack uninsulated	Johnson	108-0740-001
1	J7	3.5 mm audio jack stereo	Cui, Inc.	SJ1-3523N
2	L1, L2	Common-mode choke	Murata Manufacturing Company	DLW5BTN251SQ2L
1	R18	Resistor film, 1206, 47 k Ω	Multicomp	MC 0.125W 1206 1% 47K
1	R19	Resistor thick film, 1206, 10 k Ω , 0.25 W	Panasonic	ERJ-8ENF1002V
3	R5 to R7	Resistor thick film, 1206, 4.99 k Ω , 1%	Panasonic	ERJ-8ENF4991V
4	TP1 to TP4	CONN-PCB, test point, black	Components Corporation	TP-104-01-00
1	U1	SSM3302 Class-D amplifier	Analog Devices	SSM3302ACPZ
1	USBI	10-pin box header	3M	N2510-6002RB

**ESD Caution**

ESD (electrostatic discharge) sensitive device. Charged devices and circuit boards can discharge without detection. Although this product features patented or proprietary protection circuitry, damage may occur on devices subjected to high energy ESD. Therefore, proper ESD precautions should be taken to avoid performance degradation or loss of functionality.

Legal Terms and Conditions

By using the evaluation board discussed herein (together with any tools, components documentation or support materials, the "Evaluation Board"), you are agreeing to be bound by the terms and conditions set forth below ("Agreement") unless you have purchased the Evaluation Board, in which case the Analog Devices Standard Terms and Conditions of Sale shall govern. Do not use the Evaluation Board until you have read and agreed to the Agreement. Your use of the Evaluation Board shall signify your acceptance of the Agreement. This Agreement is made by and between you ("Customer") and Analog Devices, Inc. ("ADI"), with its principal place of business at One Technology Way, Norwood, MA 02062, USA. Subject to the terms and conditions of the Agreement, ADI hereby grants to Customer a free, limited, personal, temporary, non-exclusive, non-sublicensable, non-transferable license to use the Evaluation Board FOR EVALUATION PURPOSES ONLY. Customer understands and agrees that the Evaluation Board is provided for the sole and exclusive purpose referenced above, and agrees not to use the Evaluation Board for any other purpose. Furthermore, the license granted is expressly made subject to the following additional limitations: Customer shall not (i) rent, lease, display, sell, transfer, assign, sublicense, or distribute the Evaluation Board; and (ii) permit any Third Party to access the Evaluation Board. As used herein, the term "Third Party" includes any entity other than ADI, Customer, their employees, affiliates and in-house consultants. The Evaluation Board is NOT sold to Customer; all rights not expressly granted herein, including ownership of the Evaluation Board, are reserved by ADI. CONFIDENTIALITY. This Agreement and the Evaluation Board shall all be considered the confidential and proprietary information of ADI. Customer may not disclose or transfer any portion of the Evaluation Board to any other party for any reason. Upon discontinuation of use of the Evaluation Board or termination of this Agreement, Customer agrees to promptly return the Evaluation Board to ADI. ADDITIONAL RESTRICTIONS. Customer may not disassemble, decompile or reverse engineer chips on the Evaluation Board. Customer shall inform ADI of any occurred damages or any modifications or alterations it makes to the Evaluation Board, including but not limited to soldering or any other activity that affects the material content of the Evaluation Board. Modifications to the Evaluation Board must comply with applicable law, including but not limited to the RoHS Directive. TERMINATION. ADI may terminate this Agreement at any time upon giving written notice to Customer. Customer agrees to return to ADI the Evaluation Board at that time. LIMITATION OF LIABILITY. THE EVALUATION BOARD PROVIDED HEREUNDER IS PROVIDED "AS IS" AND ADI MAKES NO WARRANTIES OR REPRESENTATIONS OF ANY KIND WITH RESPECT TO IT. ADI SPECIFICALLY DISCLAIMS ANY REPRESENTATIONS, ENDORSEMENTS, GUARANTEES, OR WARRANTIES, EXPRESS OR IMPLIED, RELATED TO THE EVALUATION BOARD INCLUDING, BUT NOT LIMITED TO, THE IMPLIED WARRANTY OF MERCHANTABILITY, TITLE, FITNESS FOR A PARTICULAR PURPOSE OR NON-INFRINGEMENT OF INTELLECTUAL PROPERTY RIGHTS. IN NO EVENT WILL ADI AND ITS LICENSORS BE LIABLE FOR ANY INCIDENTAL, SPECIAL, INDIRECT, OR CONSEQUENTIAL DAMAGES RESULTING FROM CUSTOMER'S POSSESSION OR USE OF THE EVALUATION BOARD, INCLUDING BUT NOT LIMITED TO LOST PROFITS, DELAY COSTS, LABOR COSTS OR LOSS OF GOODWILL. ADI'S TOTAL LIABILITY FROM ANY AND ALL CAUSES SHALL BE LIMITED TO THE AMOUNT OF ONE HUNDRED US DOLLARS (\$100.00). EXPORT. Customer agrees that it will not directly or indirectly export the Evaluation Board to another country, and that it will comply with all applicable United States federal laws and regulations relating to exports. GOVERNING LAW. This Agreement shall be governed by and construed in accordance with the substantive laws of the Commonwealth of Massachusetts (excluding conflict of law rules). Any legal action regarding this Agreement will be heard in the state or federal courts having jurisdiction in Suffolk County, Massachusetts, and Customer hereby submits to the personal jurisdiction and venue of such courts. The United Nations Convention on Contracts for the International Sale of Goods shall not apply to this Agreement and is expressly disclaimed.