

PJ Open Frame Power Supply

24 V 150 W 1 Phase / PJ-24V150W□□A

PJ

Highlights & Features

- Universal AC Input (85 Vac – 264 Vac)
- Low Inrush Current / Low Leakage Current
- High efficiency and PF factor to conserve energy
- Conforms to harmonic current IEC/EN/BS EN 61000-3-2, Class D
- Conformal coating on PCBA to protect against chemical and dust pollutants
- Remote ON/OFF (Optional for 150W)
- Versatile configuration options: Open Frame, L Frame, Enclosed
- Long life capacitors



Safety Standards



CB Certified for worldwide use

| | |
|--------------------------------|--|
| Model Number: | PJ-24V150W□□A |
| Unit Weight: | Open Frame: 0.29 kg (0.64 lb) Enclosed: 0.50 kg (1.10 lb) |
| Dimensions (L x W x H): | Open Frame: 160 x 75 x 37 mm (6.30 x 2.95 x 1.46 inch) Enclosed: 188 x 85 x 47 mm (7.40 x 3.35 x 1.85 inch) |

General Description

The PJ series of Open Frame Power Supply comes with universal AC input at 85Vac to 264Vac. Other features include low leakage / Inrush current and conformal coating on the PCBAs to provide protection against dust and chemical pollutants. The built-in active PFC provides PF > 0.97 and fulfills Harmonic Current Emission according to IEC/EN/BS EN 61000-3-2. The PJ series is certified for EMC standards according to EN/BS EN 55011 for industrial, scientific and medical (ISM) radio-frequency equipment and EN/BS EN 55032 for Industrial Technology Equipment (ITE) radio-frequency equipment and EMS according to EN/BS EN 55024.

Metal chassis and case cover are available as options for different installation preferences. The PJ series conforms to major international safety standards according to EN/UL 62368-1 standards

Model Information

PJ Open Frame Power Supply

| Model Number | Input Voltage Range | Rated Output Voltage | Rated Output Current |
|---------------|---------------------|----------------------|----------------------|
| PJ-24V150W□□A | 85-264 Vac | 24 Vdc | 6.30 A |

Model Numbering

| | | | | CC Code | |
|-----------|----------------|--------------|---|--|----------------|
| PJ – | 24 V | 150 W | □ | □ | A |
| PJ Series | Output Voltage | Output Power | Product Type B - Open Frame L - L Frame C - Enclosed | Remote ON/OFF Function N - No Remote ON/OFF R - With Remote ON/OFF | Delta Standard |

PJ Open Frame Power Supply

24 V 150 W 1 Phase / PJ-24V150W□□A

Specifications

Input Ratings / Characteristics

| | |
|---------------------------------|--|
| Nominal Input Voltage | 100-240 Vac |
| Input Voltage Range | 85-264 Vac |
| Nominal Input Frequency | 50-60 Hz |
| Input Frequency Range | 47-63 Hz |
| Input Current | 1.90 A typ. @ 100 Vac, 0.95 A typ. @ 200 Vac |
| Efficiency at 100% Load | 88.0% typ. @ 100 Vac, 91.0% typ. @ 200 Vac |
| Max Inrush Current (Cold Start) | 15 A typ. @ 100 Vac, 30 A typ. @ 200 Vac |
| Power Factor Correction | 0.99 typ. @ 100 Vac, 0.97 typ. @ 200 Vac |
| Leakage Current | 0.2 mA @ 100 Vac, 0.4 mA @ 240 Vac |

Output Ratings / Characteristics*

| | |
|--|---|
| Nominal Output Voltage | 24 Vdc |
| Output Voltage Tolerance | ± 1% (initial set point tolerance from factory) |
| Output Voltage Adjustment Range | 21.6-26.4 Vdc |
| Output Current | 6.30 A |
| Output Power | 150 W |
| Line Regulation | < 96 mV |
| Load Regulation | < 150 mV |
| Ripple Noise (20MHz) | < 150 mVpp @ 0°C to 50°C, < 180 mVpp @ -10°C to 0°C |
| Start-up Time | 500 ms typ. @ 100 Vac |
| Hold-up Time | 20 ms typ. @ 100 Vac (100% load) |
| Dynamic Response (Overshoot & Undershoot O/P Voltage) | ± 5% @ 0-50% load and 50-100% load (Slew Rate: 0.1 A/μS) |
| Start-up with Capacitive Loads | 4,000 μF Max |

*For power de-rating from 50°C to 70°C, see power de-rating on page 3

Mechanical

| | | |
|----------------------|------------|--|
| Case Cover / Chassis | SGCC | |
| Dimensions | Open Frame | 160 x 75 x 37 mm (6.30 x 2.95 x 1.46 inch) |
| | Enclosed | 188 x 85 x 47 mm (7.40 x 3.35 x 1.85 inch) |
| Unit Weight | Open Frame | 0.29 kg (0.64 lb) |
| | Enclosed | 0.50 kg (1.10 lb) |
| Indicator | NA | |
| Cooling System | Convection | |
| Terminal | Input | JST B3P5-VH (LF)(SN) |
| | Output | V-: JST B7P-VH (LF)(SN), V+: JST B6P-VH (LF)(SN) |
| Wire | AWG 22-18 | |

PJ Open Frame Power Supply

24 V 150 W 1 Phase / PJ-24V150W□□A

Environment

| | | |
|-----------------------------|--|----------------|
| Surrounding Air Temperature | Operating | -10°C to +70°C |
| | Storage | -25°C to +75°C |
| Power De-rating | Refer to Engineering Data Fig.1.1~Fig.1.5 on Page7~9 | |
| Operating Humidity | 5 to 90% RH (Non-Condensing) | |
| Operating Altitude | 0 to 5,000 Meters (16,400 ft) | |
| Shock Test (Non-Operating) | IEC 60068-2-27, 196.1m/S ² (20G),11 ms, once along X, Y, and Z axis | |
| Vibration (Operating) | IEC 60068-2-6, 10Hz to 55Hz @ 19.6m/S ² (2G); 3 min period, 60 min per axis for all X, Y, Z direction | |

Protections

| | |
|--------------------------|---|
| Overvoltage | 27.6-33.6 V, Latch Mode |
| Overload / Overcurrent | > 105% of rated load current, Hiccup Mode, Non-Latching (Auto-Recovery) |
| Over Temperature | Latch Mode |
| Short Circuit | Hiccup Mode, Non-Latching (Auto-Recovery when the fault is removed) |
| Protection Against Shock | Class I with PE* connection |

*PE: Primary Earth

Reliability Data

| | |
|------------------------|---------------------------------------|
| MTBF | > 200,000 hrs. as per JEITA RCR-9102B |
| Expected Cap Life Time | 10 years (115 Vac, 50% load @ 40°C) |

Safety Standards / Directives

| | | |
|--------------------------|---|---|
| Safety Entry Low Voltage | SELV (EN 60950-1) | |
| Electrical Safety | TUV Bauart UL/cUL recognized cCSAus | EN 60950-1, EN 62368-1 UL 60950-1 and CSA C22.2 No. 60950-1 (File No. E131881) CAN/CSA C22.2 No. 62368-1 and ANSI/UL 62368-1 (File No. E131881) |
| | CB scheme | IEC 60950-1, IEC 62368-1 |
| CE | In conformance with EMC Directive 2014/30/EU and Low Voltage Directive 2014/35/EU | |
| UKCA | In conformance with Electrical Equipment (Safety) Regulations 2016 and Electromagnetic Compatibility Regulations 2016 | |
| Galvanic Isolation | Input to Output | 3.0 KVac |
| | Input to Ground | 2.0 KVac |
| | Output to Ground | 0.5 KVac |

PJ Open Frame Power Supply

24 V 150 W 1 Phase / PJ-24V150W□□A

EMC

| | | |
|-----------------------------------|----------------|--|
| Emission (CE&RE) | | CISPR 32, EN/BS EN 55032, Comply with FCC Title 47: Class B |
| Immunity to | | EN/BS EN 55024 |
| Electrostatic Discharge | IEC 61000-4-2 | Level 4 Criteria A ¹⁾ Air Discharge: 15 kV Contact Discharge: 8 kV |
| Radiated Field | IEC 61000-4-3 | Level 3 Criteria A ¹⁾ 80 MHz – 1 GHz, 10 V/M with 1 kHz tone / 80% modulation |
| Electrical Fast Transient / Burst | IEC 61000-4-4 | Level 3 Criteria A ¹⁾ 2 kV |
| Surge | IEC 61000-4-5 | Level 3 Criteria A ¹⁾ Common Mode ²⁾ : 2 kV Differential Mode ³⁾ : 1 kV |
| Conducted | IEC 61000-4-6 | Level 3 Criteria A ¹⁾ 150 kHz - 80 MHz, 10 Vrms |
| Power Frequency Magnetic Fields | IEC 61000-4-8 | Criteria A ¹⁾ Magnetic field strength 30 A/Meter |
| Voltage Dips | IEC 61000-4-11 | 100% dip; 1 cycle (20 ms); Self Recoverable |
| Low Energy Pulse Test (Ring Wave) | IEC 61000-4-12 | Level 3 Criteria A ¹⁾ Common Mode ²⁾ : 2 kV Differential Mode ³⁾ : 1 kV |
| Harmonic Current Emission | | IEC/EN/ BS EN 61000-3-2, Class D |
| Voltage Fluctuation and Flicker | | IEC/EN/ BS EN 61000-3-3 |

- 1) Criteria A: Normal performance within the specification limits
- 2) Asymmetrical: Common mode (Line to earth)
- 3) Symmetrical: Differential mode (Line to line)

Block Diagram

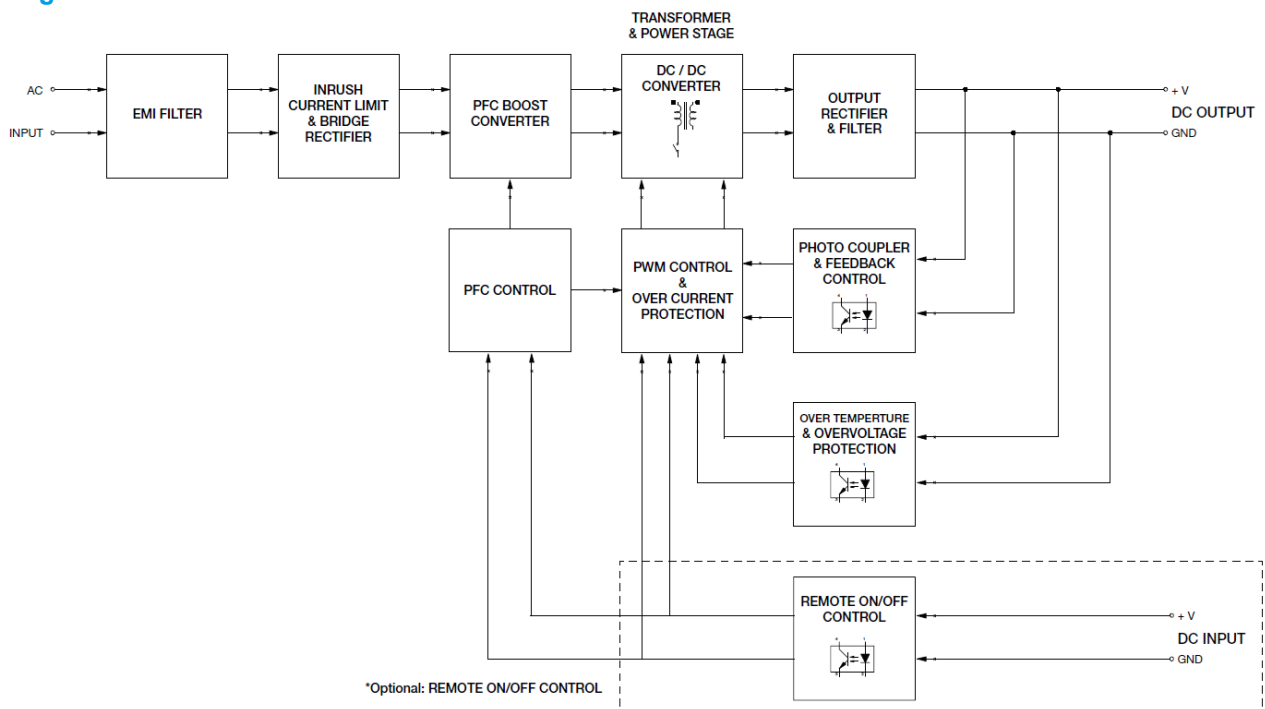

PJ Open Frame Power Supply

24 V 150 W 1 Phase / PJ-24V150W□□A

Dimensions

Open Frame

L x W x H: 160 x 75 x 37 mm (6.30 x 2.95 x 1.46 inch)

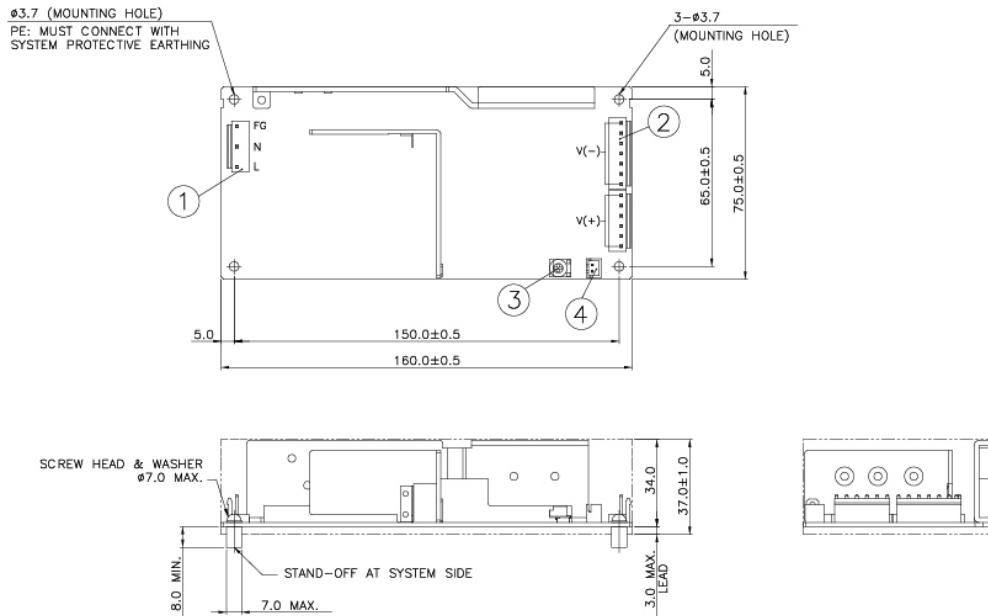

L Frame

L x W x H: 188 x 85 x 47 mm (7.40 x 3.35 x 1.85 inch)

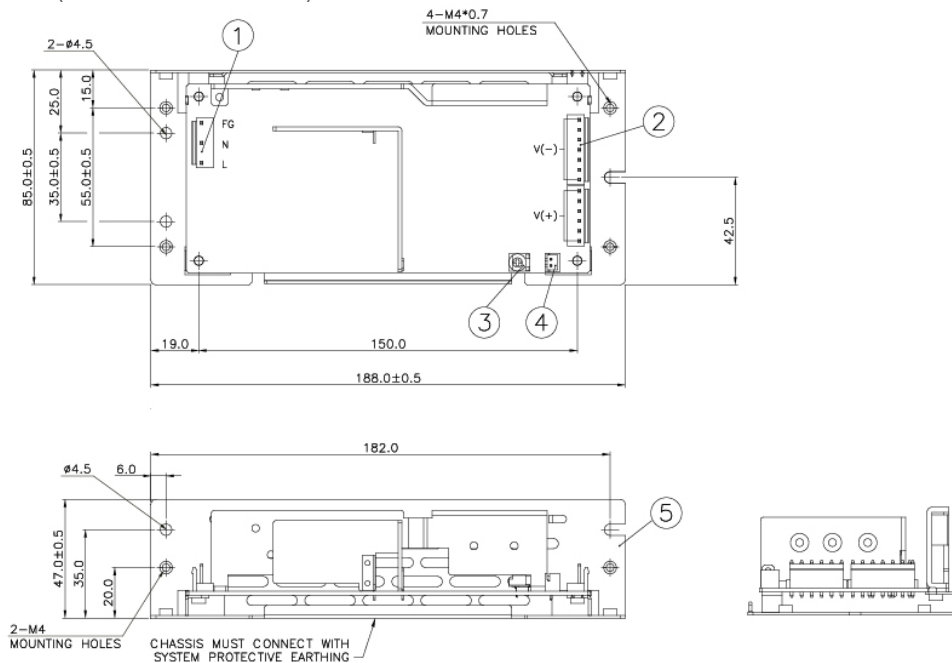

| Item | Device Description |
|------|------------------------------|
| 1 | Input Connector |
| 2 | Output Connector |
| 3 | VR |
| 4 | Remote ON/OFF (JST B2B-XH-A) |
| 5 | Chassis |

Notes

- Dimensions are in mm
- For information on Mounting Torque, and I/O Connector and Housing, please refer to the Instruction Manual.
- For L Frame type: There are 6 threaded mounting holes and 5 normal mounting holes.
- For Open Frame type: There are 4 normal mounting holes.

PJ Open Frame Power Supply

24 V 150 W 1 Phase / PJ-24V150W□□A

Enclosed

L x W x H: 188 x 85 x 47 mm (7.40 x 3.35 x 1.85 inch)

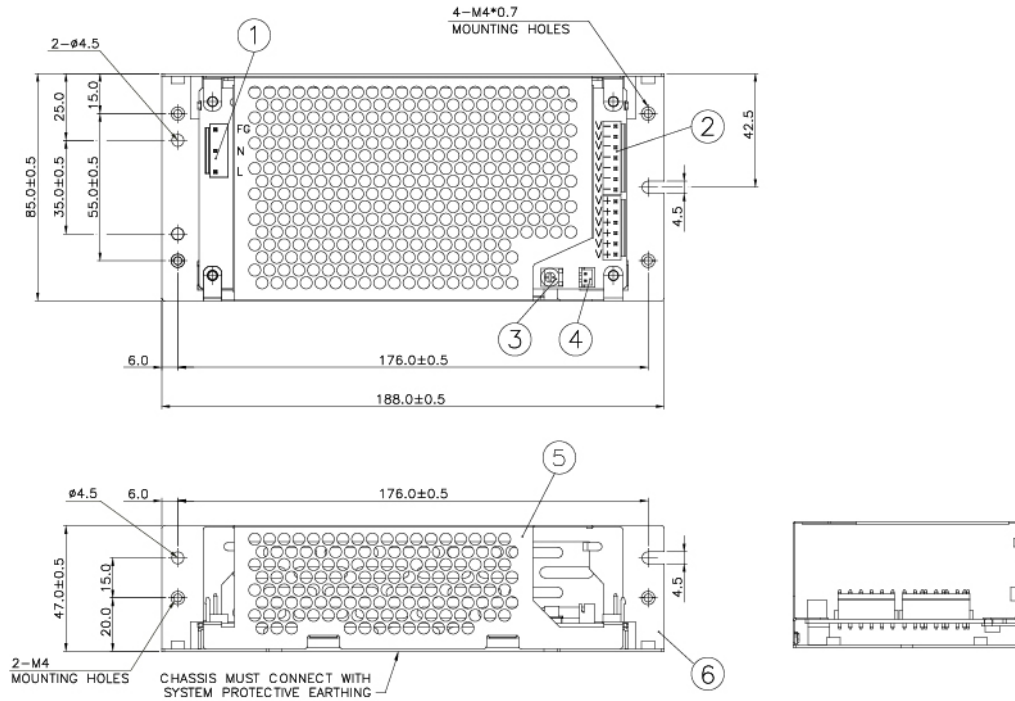

| Item | Device Description |
|------|------------------------------|
| 1 | Input Connector |
| 2 | Output Connector |
| 3 | VR |
| 4 | Remote ON/OFF (JST B2B-XH-A) |
| 5 | Cover |
| 6 | Chassis |

Notes

- Dimensions are in mm
- For information on Mounting Torque, and I/O Connector and Housing, please refer to the Instruction Manual.
- For Enclosed type: There are 6 threaded mounting holes and 5 normal mounting holes.

PJ Open Frame Power Supply

24 V 150 W 1 Phase / PJ-24V150W□□A

Assembly & Installation

■ Open Frame

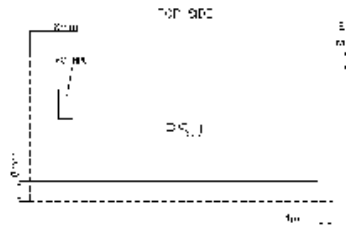

■ L Frame / Enclosed

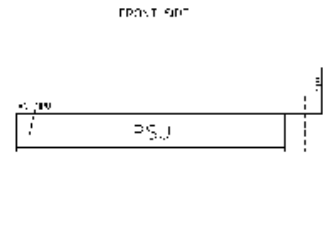
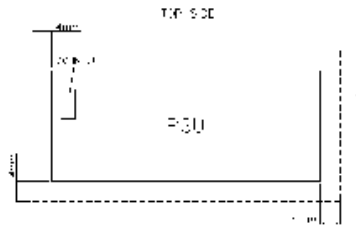
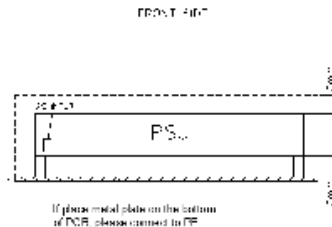

For safety reasons, please ensure the mounted device is kept safety distance as below at all sides from other components and equipments.

- a) For Open Frame Type ≥ 8 mm (0.315 inch) from primary side and ≥ 4 mm (0.16 inch) from secondary side.
- b) For with Case Type ≥ 4 mm (0.16 inch)

Please insert an insulation sheet between the system and product, if the safety distance is less than 4 mm (0.16 inch).

- Use flexible cable (stranded or solid) of AWG No. 22-18. Please refer to Table 1 for the recommended Housing and Terminal.
- For the Remote ON/OFF function, use flexible cable (stranded or solid) of AWG No. 28-22.

Table 1

| | Connector (Board Mounting) | Housing | Terminal |
|---------------------------------|----------------------------|---------|---------------|
| Input (JST) | B3P5-VH(LF)(SN) | VHR-5N | SVH-21T-P1.1 |
| Output (JST)(V-) | B7P-VH(LF)(SN) | VHR-7N | |
| Output (JST)(V+) | B6P-VH(LF)(SN) | VHR-6N | |
| Remote ON/OFF Function (Option) | B2B-XH-A(LF)(SN) | XHP-2 | SXH-001T-P0.6 |

PJ Open Frame Power Supply

24 V 150 W 1 Phase / PJ-24V150W□□A

Mounting Orientation

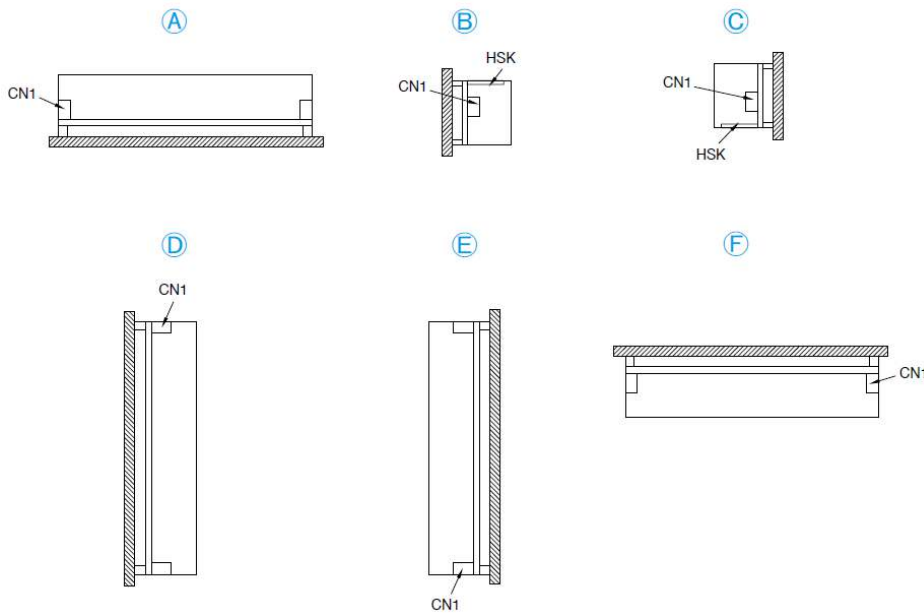

- Any excessive twisting or bending may damage the device's PCB. Please handle the device with care.
- The device is not recommended to be placed on low thermal conductive surfaces. For example, plastics.
- Prevent any foreign metal, particles or conductors from entering the device through the openings during installation. It may cause: -Electric shock; Safety hazard; Product failure.
- **The power supply must be mounted by metal screws onto a grounded metal surface. It is highly recommended that the Earth terminal on the connector be connected to the grounded metal surface.**

Engineering Data

Convection

Output Load De-rating VS Surrounding Air Temperature

■ Open Frame / L Frame

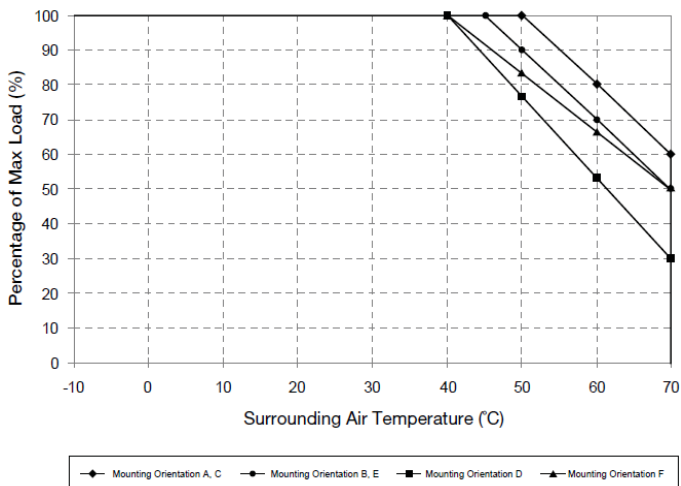

■ Enclosed

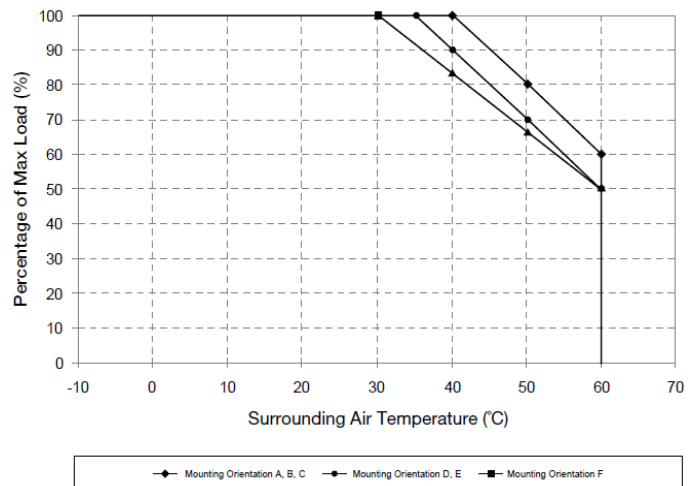

Fig. 1.1 De-rating for Mounting Orientation A, C
 > 50°C de-rate power by 2% / °C
 De-rating for Mounting Orientation B, E
 > 45°C de-rate power by 2% / °C
 De-rating for Mounting Orientation D
 > 40°C de-rate power by 2.33% / °C
 De-rating for Mounting Orientation F
 > 40°C de-rate power by 1.66% / °C

Fig. 1.2 De-rating for Mounting Orientation A, B, C
 > 40°C de-rate power by 2% / °C
 De-rating for Mounting Orientation D, E
 > 30°C de-rate power by 1.66% / °C
 De-rating for Mounting Orientation F
 > 35°C de-rate power by 2% / °C

PJ Open Frame Power Supply

24 V 150 W 1 Phase / PJ-24V150W□□A

Forced Cooling (Air Velocity > 0.7m/s)

Output Load De-rating VS Surrounding Air Temperature

■ Air Flow Direction

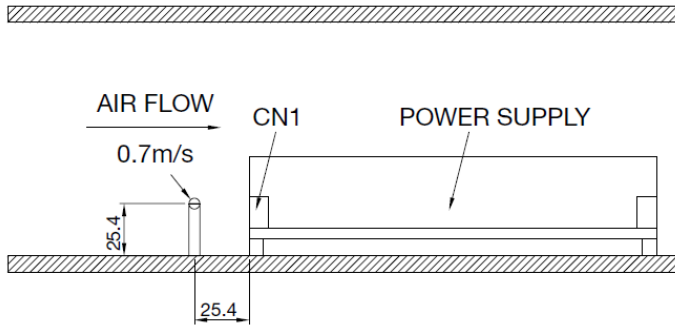

■ Open Frame / L Frame

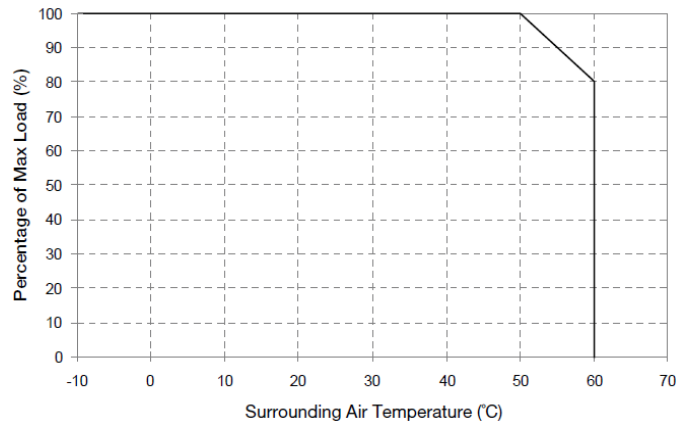
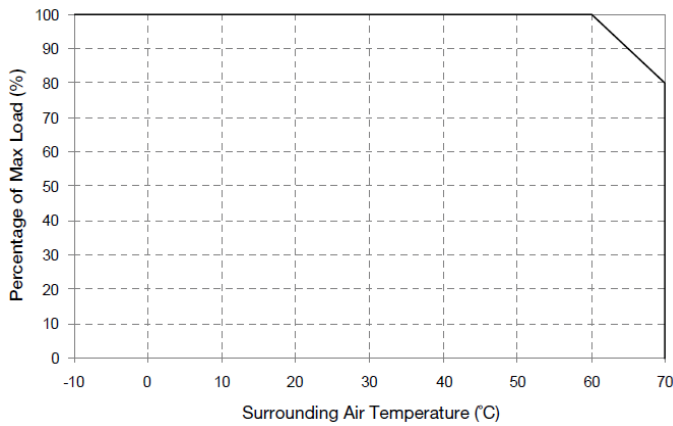

■ Enclosed

Notes

1. Power supply components may degrade, or be damaged, when the power supply is continuously used outside the shaded region, refer to the graphs shown above.
2. If the output capacity is not reduced when the surrounding air temperature is more than the upper limit temperature, the device will run into Over Temperature Protection. When activated, the output voltage will go into bouncing mode and will recover when the surrounding air temperature is lowered or the load is reduced as far as necessary to keep the device in working condition.
3. Depending on the surrounding air temperature and output load delivered by the power supply, the device housing can be very hot!
4. If the device has to be mounted in any other orientation, please do not hesitate to contact info@deltapsu.com for more details.

Fig.1.3 De-rating for Mounting Orientation A to F
> 60°C de-rate power by 2% / °C

Fig.1.4 De-rating for Mounting Orientation A to F
> 50°C de-rate power by 2% / °C

PJ Open Frame Power Supply

24 V 150 W 1 Phase / PJ-24V150W□□A

Output Load De-rating VS. Input Voltage

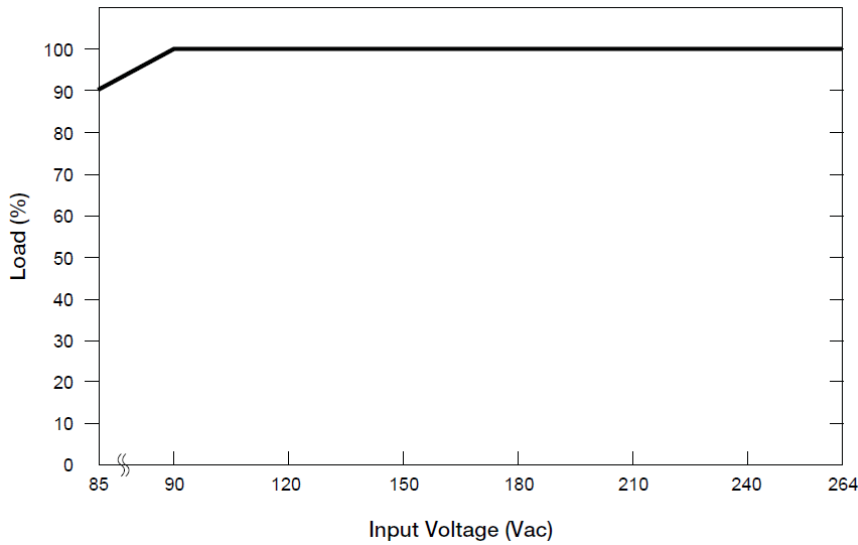

■ No output power de-rating for the input voltage range from 90 Vac to 264 Vac

Functional Manual

Remote ON/OFF Function

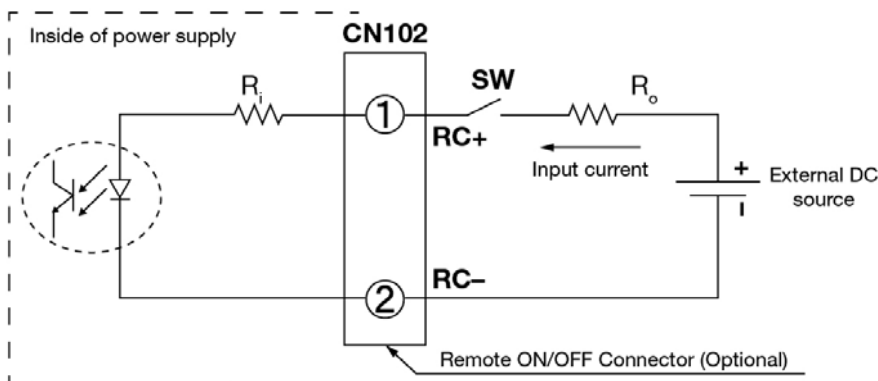

You can remotely control the power supply unit to turn ON/OFF by using an external DC source. Follow the DC power source voltage and current limiting defined in the table below.

| Built-in Resistor R_i (ohm) | Voltage Between RC+ and RC- (V) | | Input Current (mA) |
|-------------------------------|---------------------------------|------------|--------------------|
| | Output ON | Output OFF | |
| 1k | 5-12.5 | 0-0.5 | 20 Max |

Notes

1. Remote ON/OFF circuits are isolated from input, output and PE.
2. Please check if the polarity of the wire connector is the same as the external DC source. If not, the power would not turn on and the internal components may be damaged.
3. You do not need an external resistance R_o for current limit while the output voltage of external DC source is within the range of 5-12.5 V. If the output voltage exceeds 12.5 V, please use the following equation for the value of current limit resistance R_o .

$$R_o = \frac{V_{cc} - (3.5 + 0.006R_i)}{0.006}$$

PJ Open Frame Power Supply

24 V 150 W 1 Phase / PJ-24V150W□□A

Functions

Start-up Time

The time required for the output voltage to reach 90% of its final steady state set value, after the input voltage is applied.

Rise Time

The time required for the output voltage to change from 10% to 90% of its final steady state set value.

Hold-up Time

Time between the collapse of the AC input voltage, and the output falling to 95% of its steady state set value.

■ Graph illustrating the Start-up Time, Rise Time, and Hold-up Time

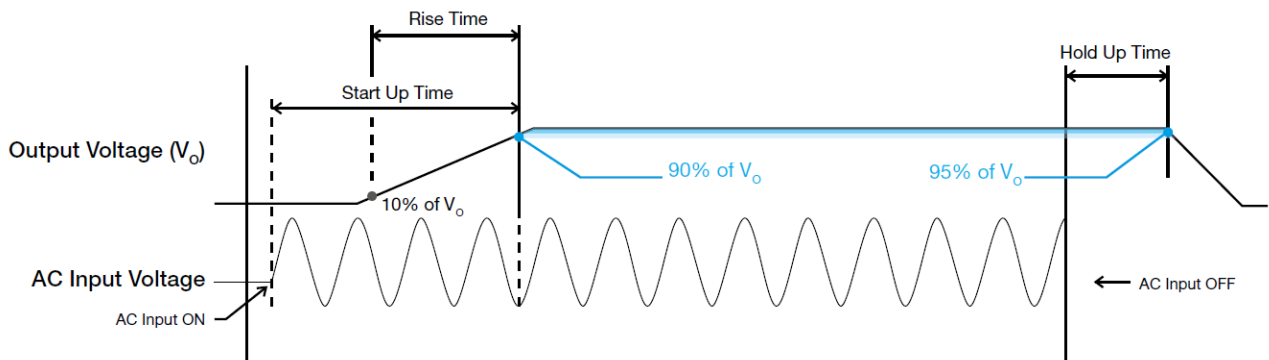

Dynamic Response

The power supply output voltage will remain within $\pm 5\%$ of its steady state value, when subjected to a dynamic load from 0% to 100% of its rated current.

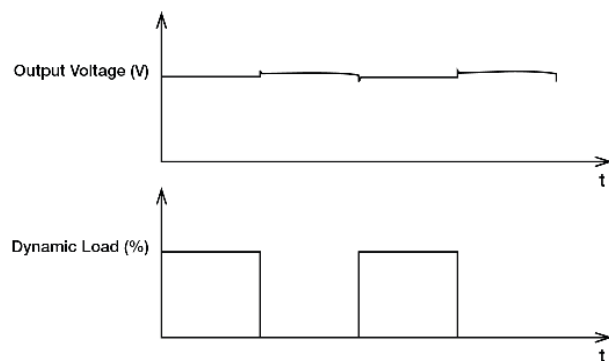

PJ Open Frame Power Supply

24 V 150 W 1 Phase / PJ-24V150W□□A

Inrush Current

Inrush current is the peak, instantaneous, input current measured and, occurs when the input voltage is first applied. For AC input voltages, the maximum peak value of inrush current will occur during the first half cycle of the applied AC voltage. This peak value decreases exponentially during subsequent cycles of AC voltage.

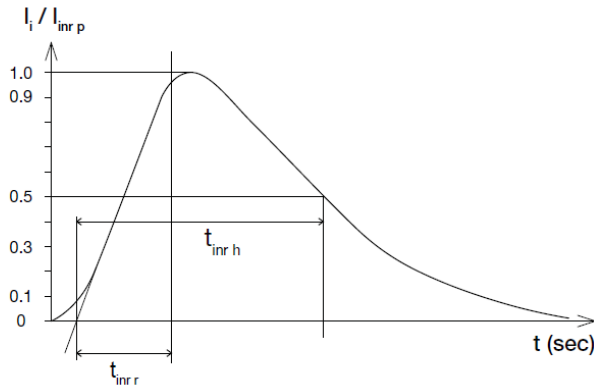

Overvoltage Protection

The power supply's overvoltage circuit will be activated when its internal feedback circuit fails. The output voltage shall not exceed its specifications defined on Page 3 under "Protections".

The power supply should be latch.

Short Circuit Protection (Auto-Recovery)

The power supply's output OLP/OCP function also provides protection against short circuits. When a short circuit is applied, the output current will operate in "Hiccup mode", as shown in the illustration in the OLP/OCP section on this page. The power supply will return to normal operation after the short circuit is removed.

Overload & Overcurrent Protections (Auto-Recovery)

The power supply's Overload (OLP) and Overcurrent (OCP) Protections will be activated when output current exceeds 105% of I_o (Max load). In such occurrence, the V_o will start to droop and once the power supply has reached its maximum power limit, the protection is activated and the power supply will go into "Hiccup mode" (Auto-Recovery). The power supply will recover once the fault condition of the OLP and OCP is removed and I_o is back within the specifications.

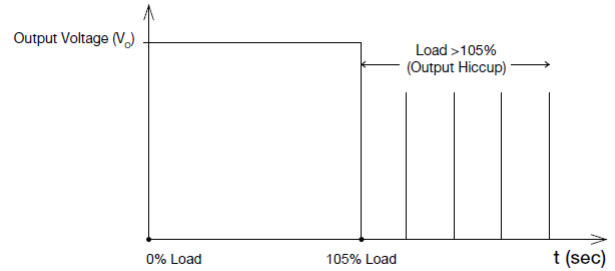

Additionally, if the I_o is $<105%$ but $>100%$ for a prolonged period of time (depending on the load), the Over Temperature Protection (OTP) will be activated due to high temperature on critical components. The power supply will then go into latch mode until the fault is removed and the mains is reapplied.

Over Temperature Protection

As mentioned above, the power supply also has Over Temperature Protection (OTP). This is activated when the overload condition persists for an extended duration and the output current is below the overload trigger point but $>100%$ load. In the event of a higher operating condition at 100% load, the power supply will run into OTP when the surrounding air temperature is higher than the operating temperature. When activated, the output voltage will go into latch mode until the mains is reapplied and the surrounding air temperature drops to its normal operating temperature.

PJ Open Frame Power Supply

24 V 150 W 1 Phase / PJ-24V150W□□A

Others

Conformal Coating



The Protective Coating Technology

Delta Electronics Group has designed the perfect dipping technique which penetrates everywhere including under device, and prevents leakage. The conformal coating dipping can be applied to PCBs or circuit board. The coating preserves the performance of precision electronic primarily by preventing ionizable contaminants such as salt from reaching circuit nodes, where the material slumps around sharp edges. This can be a problem especially in highly conversing atmosphere.

Attention

Delta provides all information in the datasheets on an "AS IS" basis and does not offer any kind of warranty through the information for using the product. In the event of any discrepancy between the information in the catalog and datasheets, the datasheets shall prevail (please refer to www.DeltaPSU.com for the latest datasheets information). Delta shall have no liability of indemnification for any claim or action arising from any error for the provided information in the datasheets. Customer shall take its responsibility for evaluation of using the product before placing an order with Delta.

Delta reserves the right to make changes to the information described in the datasheets without notice.

Manufacturer and Authorized Representatives Information

Manufacturer

Thailand

Delta Electronics (Thailand) PCL.
909 Pattana 1 Rd., Muang, Samutprakarn, 10280 Thailand

Taiwan

Delta Electronics, Inc.
3 Tungyuan Road, Chungli Industrial Zone, Taoyuan County
32063, Taiwan

Authorized Representatives

The Netherlands

Delta Greentech (Netherlands) B.V.
Zandsteen 15, 2132 MZ Hoofddorp, The Netherlands

United Kingdom

Delta Electronics Europe Limited
1 Redwood Court, Peel Park Campus,
East Kilbride, Glasgow, G74 5PF, United Kingdom