

ISOLATION TYPE DC/DC CONVERTER 2DD151008C

■ Overview

2DDxxxxxC series are insulated DC/DC converters for gate drivers such as SiC MOSFET and IGBT. The high breakdown voltage and low parasitic capacitance make it suitable for gate drives such as SiC MOSFET and IGBT.

■ Feature

- Ideal for gate drive power supply
- Ideal for half-bridge operation by dual output
- Gate voltage : +15V/-10V
- Low parasitic capacitance (about 9 pF); highly resistant to common-mode noise.
- Input-to-Output dielectric withstand voltage : AC5000V
- Output-to-Output dielectric withstand voltage : AC4000V
- Input-to-Output insulation distance : 14mm (clearance·creepage)
- Output-to-Output insulation distance : 12mm (clearance·creepage)
- Input voltage : 13.5~26.4V
- Over load protection
- Over heat protection
- Filling structure
- Safety standards:UL508(file no.E243511)



■ Applications

Inverters for industrial equipment, power conditioners, etc...

■ Connection example

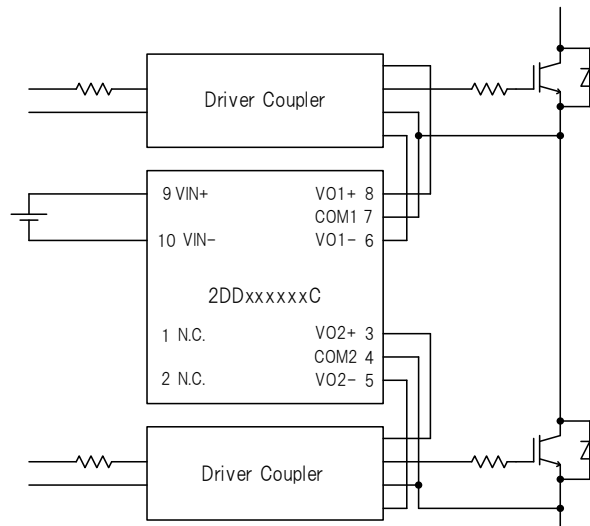

■Block diagram

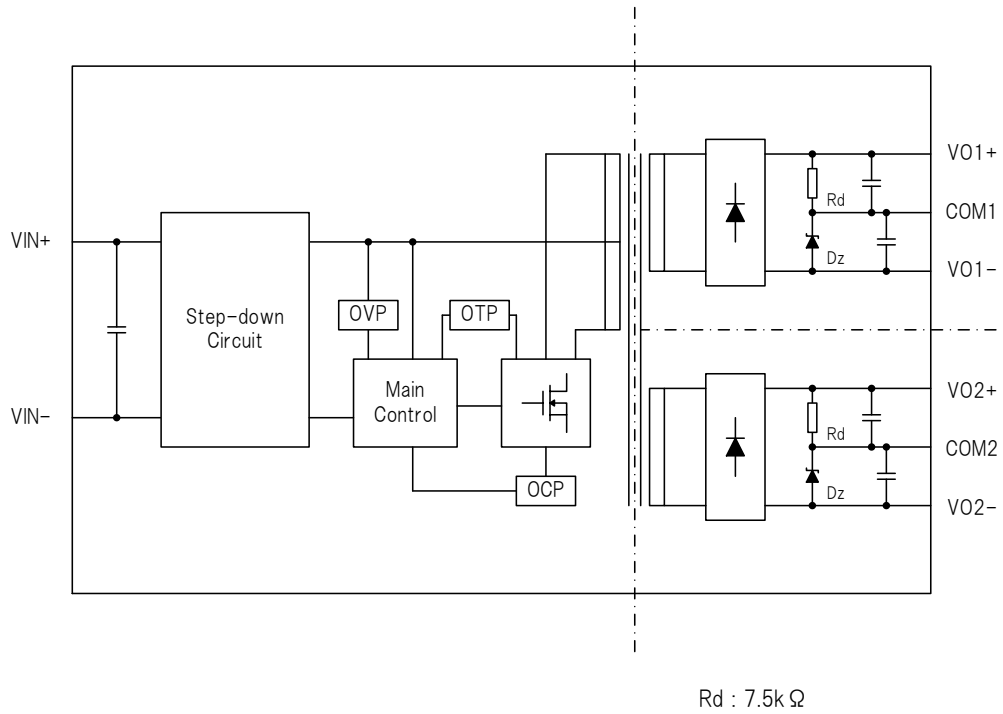

■Pin connection

Pin No.	Name	Explanation of pins
1	N.C.	Unused ※Unable to connect to other circuits
2	N.C.	Unused ※Unable to connect to other circuits
3	V02+	Output2 plus
4	COM2	Output2 common
5	V02-	Output2 minus
6	V01-	Output1 minus
7	COM1	Output1 common
8	V01+	Output1 plus
9	VIN+	Input plus
10	VIN-	Input minus

■ Absolute maximum rating

Item	Symbol	Min	Max	Unit	Conditions·Note
Input voltage	V_{IN}	-0.3	28	Vdc	Between V_{IN+} — V_{IN-}
Output power	$T_a=75/85^{\circ}\text{C}$ P_{OUT}	-	4	W	Per output circuit
	$T_a=60^{\circ}\text{C}$ P_{OUT}	-	5	W	
Output current	$T_a=75/85^{\circ}\text{C}$ $I_{OUT1,2}$	0	160	mA	Per output circuit
	$T_a=60^{\circ}\text{C}$ $I_{OUT1,2}$	0	200	mA	
COM sink current	$I_{COM1,2}$	0	10	mA	Per output circuit
Operating ambient temperature range	$V_{IN}=13\text{V}\sim 18\text{V}$ T_{OP}	-40	85	$^{\circ}\text{C}$	
	$V_{IN}=18\text{V}\sim 28\text{V}$ T_{OP}	-40	75	$^{\circ}\text{C}$	
Operating ambient humidity range	RH_{OP}	20	95	%RH	No condensation
Storage temperature range	T_{STG}	-40	90	$^{\circ}\text{C}$	
Storage humidity range	RH_{STG}	5	95	%RH	No condensation

■ Recommended Operating Voltage

Item	Symbol	Min	Max	Unit	Conditions·Note
Input voltage range	V_{IN}	13.5	26.4	Vdc	By temperature derating
Output power	P_{OUT}	-	4	W	Per output circuit. $I_{COM1}=I_{COM2}=0\text{A}$
Output current	$I_{OUT1,2}$	10	160	mA	Per output circuit. $I_{COM1}=I_{COM2}=0\text{A}$
Number of output circuit	N	-	2	-	

■ Electrical Specification ($V_{IN}=24\text{V}$, $I_{OUT1}=I_{OUT2}=160\text{mA}$, $I_{COM1}=I_{COM2}=0\text{A}$, $T_a=25^{\circ}\text{C}$. Unless otherwise specified)

Item	Symbol	Min	Typ	Max	Unit	Conditions·Note	
Start-up voltage	V_{START}	-	-	13	V		
Efficiency	$V_{IN}=15\text{V}$ Effi	75	80.5	-	%		
	$V_{IN}=24\text{V}$ Effi	75	79.5	-			
Standby power	$V_{IN}=15\text{V}$ P_{STBY}	-	0.7	-	W	No-load	
	$V_{IN}=24\text{V}$ P_{STBY}	-	0.9	1.2			
Output voltage(+)	Range	V_{1+}, V_{2+}	14	15	16	V	$I_{OUT1}=I_{OUT2}=10\sim 160\text{mA}$
		V_{1+}, V_{2+}	14	15	16.5	V	$I_{OUT1}=I_{OUT2}=0\sim 10\text{mA}$
	Input regulation	-	-	50	mV		
	Load regulation	-	-	1000	mV	$I_{OUT1}=I_{OUT2}=10\sim 160\text{mA}$	
		-	-	1200	mV	$I_{OUT1}=I_{OUT2}=0\sim 160\text{mA}$	
	Ripple	-	-	150	mVp-p		
	Ripple noise	-	-	200	mVp-p		
Load imbalance	V_{1+}, V_{2+}	-	-	17	V	$I_{OUT1}=160\text{mA}, I_{OUT2}=0\text{A}$ or $I_{OUT1}=0\text{A}, I_{OUT2}=160\text{mA}$	
Output voltage(-)	Range	V_{1-}, V_{2-}	-11	-10	-9	V	$I_{OUT1}=I_{OUT2}=0\sim 160\text{mA}$
		V_{1-}, V_{2-}	-	-	-	V	
	Input regulation	-	-	20	mV		
	Load regulation	-	-	100	mV		
	Ripple	-	-	100	mVp-p		
	Ripple noise	-	-	150	mVp-p		
	Load imbalance	V_{1-}, V_{2-}	-12	-	-	V	$I_{OUT1}=160\text{mA}, I_{OUT2}=0\text{A}$ or $I_{OUT1}=0\text{A}, I_{OUT2}=160\text{mA}$

■Protection function

Item	Symbol	Min	Typ	Max	Unit	Conditions·Note
Over load protection	-	10.5	-	-	W	Auto recovery
Over heat protection	-	120	-	150	°C	Auto recovery /Case surface temperature

■Insulation

Item	Specification	Conditions·Note
Between Input-Output1,2		
Dielectric withstand voltage	AC5000V	1min, Leak Current 2mA or less
Insulation resistance	100MΩ or more	DC500V
Minimum clearance distances	14mm	
Minimum creepage distances	14mm	
Between Output1-Output2		
Dielectric withstand voltage	AC4000V	1min, Leak Current 2mA or less
Insulation resistance	100MΩ or more	DC500V
Minimum clearance distances	12mm	
Minimum creepage distances	12mm	

■Temperature derating

Load power shall be reduced according to temperature derating.

Output Power 100% = Output Current 160mA

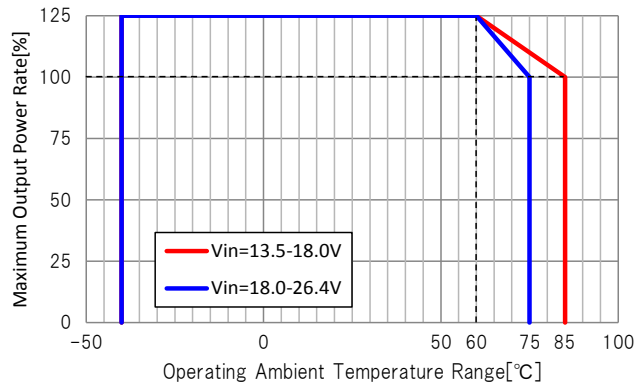

■ Typical characteristics (Ta=25°C, I_{COM1}=I_{COM2}=0A)

Output Current vs. Efficiency

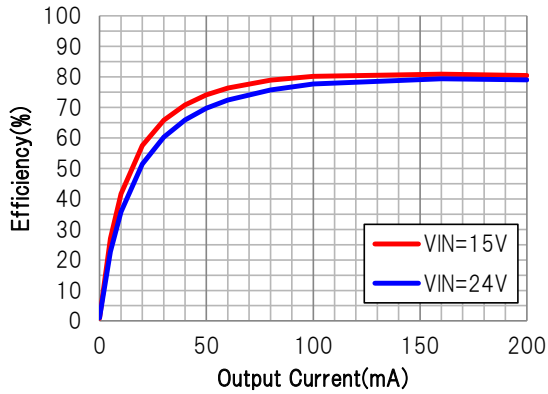

Output Current vs. Input Power

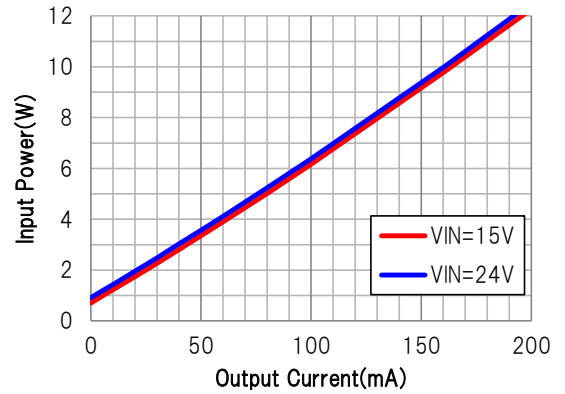

Output Current vs. Output Voltage 1+/2+

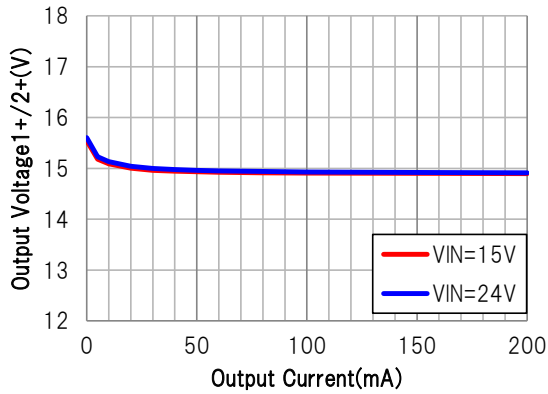

Output Current vs. Output Voltage 1-/2-

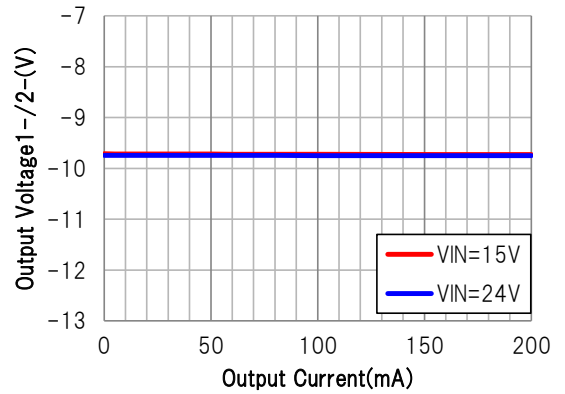

Input Voltage vs. Output Voltage 1+/2+

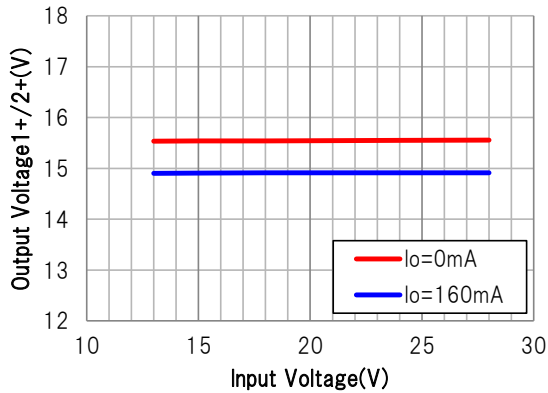

Input Voltage vs. Output Voltage 1-/2-

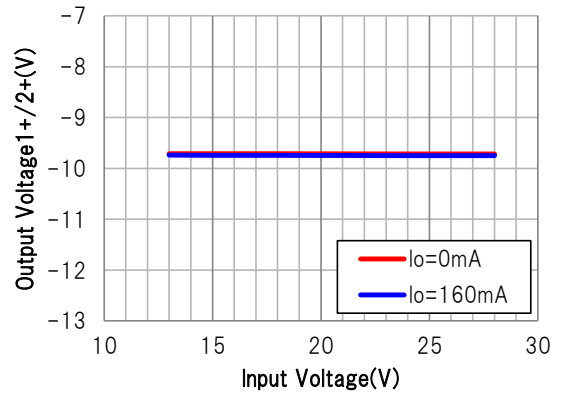

■ Typical characteristics (Ta=25°C, I_{COM1}=I_{COM2}=0A)

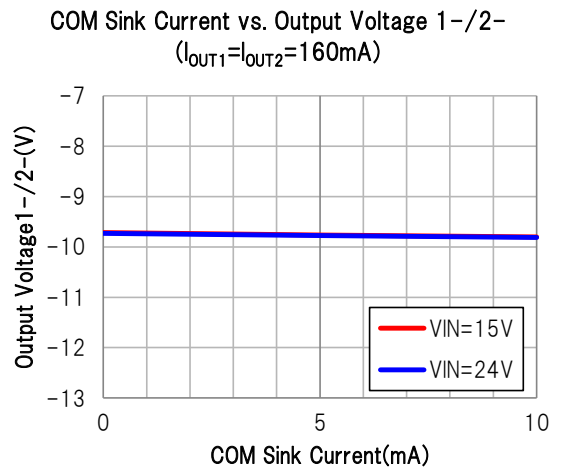
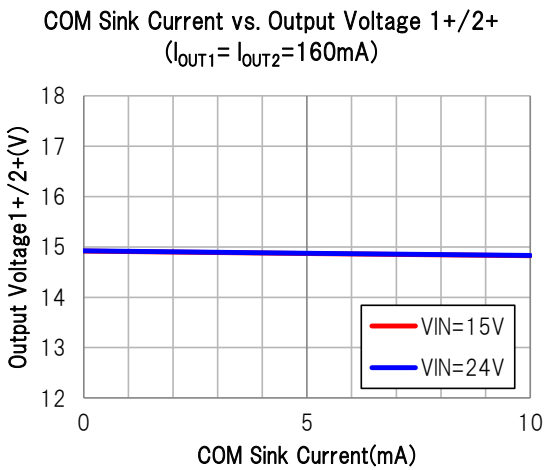
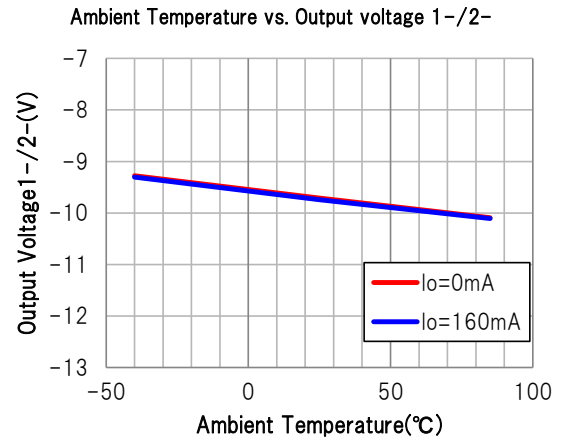
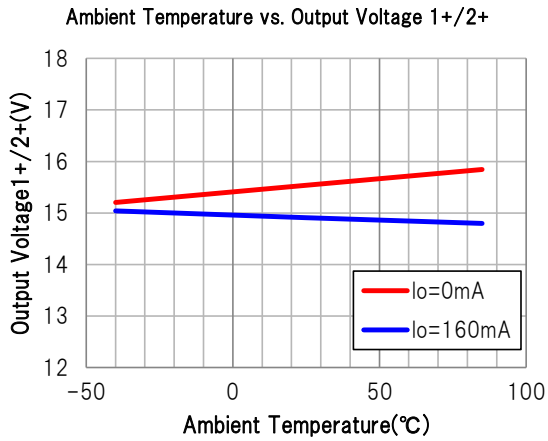

■ Measurement circuit

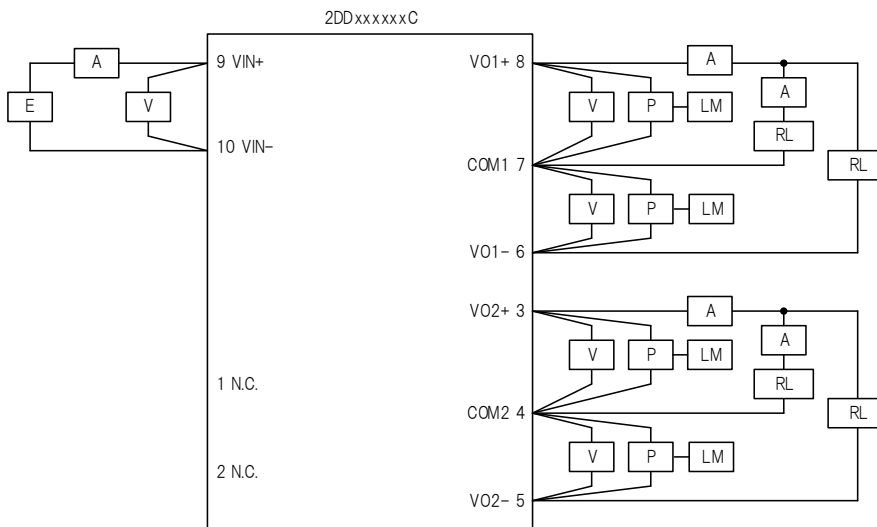

- E : DC power supply
- RL : Electronic load
- V : Voltmeter Class 0.5
- A : Ammeter Class 0.5
- P : Differential probe DP-100(KG)
- LM : Ripple noise meter RM-103(KG)

■ Reliability

Item	Test condition and acceptance criterion
Exposure in high temperature	90°C, 240H, ※
Exposure in low temperature	-40°C, 240H, ※
Exposure in high temperature and high humidity	85°C, 85%RH, 240H, ※
Thermal shock	-40°C/30min to 125°C/30min, 500cycles, ※
Low temperature operation	Input voltage:DC24V, Output current:Rated Load -40°C, 240H, ※
High temperature operation	Input voltage:DC15V, Output current:Rated Load 85°C, 240H, ※
high temperature and high humidity operation	Input voltage:DC15V, Output current:Rated Load 85°C, 85%RH, 240H, ※
Vibration	Vibration amplitude:1.5mm(peak to peak), Vibration Frequency:10 to 55Hz, Sweeping:1min. In each X, Y and Z direction:once, 120min. ※
Impact	Acceleration:490m/s ² (50G), Operating time:11ms In each ±X, Y and Z direction:3 times, ※
Drop test for packaged freights	Dorp to concrete. Height:40cm Dorp surface:1 corner, 3 spines, 6 surfaces, 1 time each.
Solderblity	Sample shall be dipped into the solution of Methanol and Rosin (having 75% Methanol and having 25% Rosin by weight measuring) and shall be dippend into the solder bath having the solder Sn-3Ag-0.5Cu of 250±5°C to the position to 3mm from the end of terminal for 3.0±0.5 seconds, and pulled up. After above treatment, the sample shall be coveredby solder uniformly at more than 75% of circumference and shall not show any unusual appearance.
Resistance to soldering heat	Sample shall be dipped into the solution of Methanol and Rosin (having 75% Methanol and having 25% Rosin by weight measuring) and shall be dippend into the solder bath having the solder Sn-3Ag-0.5Cu of 260±5°C to the position to 3mm from the end of terminal for 10.0±0.5 seconds, and pulled up. After that sample shall be replace in normal ambient for 1~2 hours and shall not show any unusual appearance.

※After each test, exposure at room temperature and humidity condition for 24 hours.

There shall be no abnormality on the electrical specification and appearance.

■Dimensional outline drawing

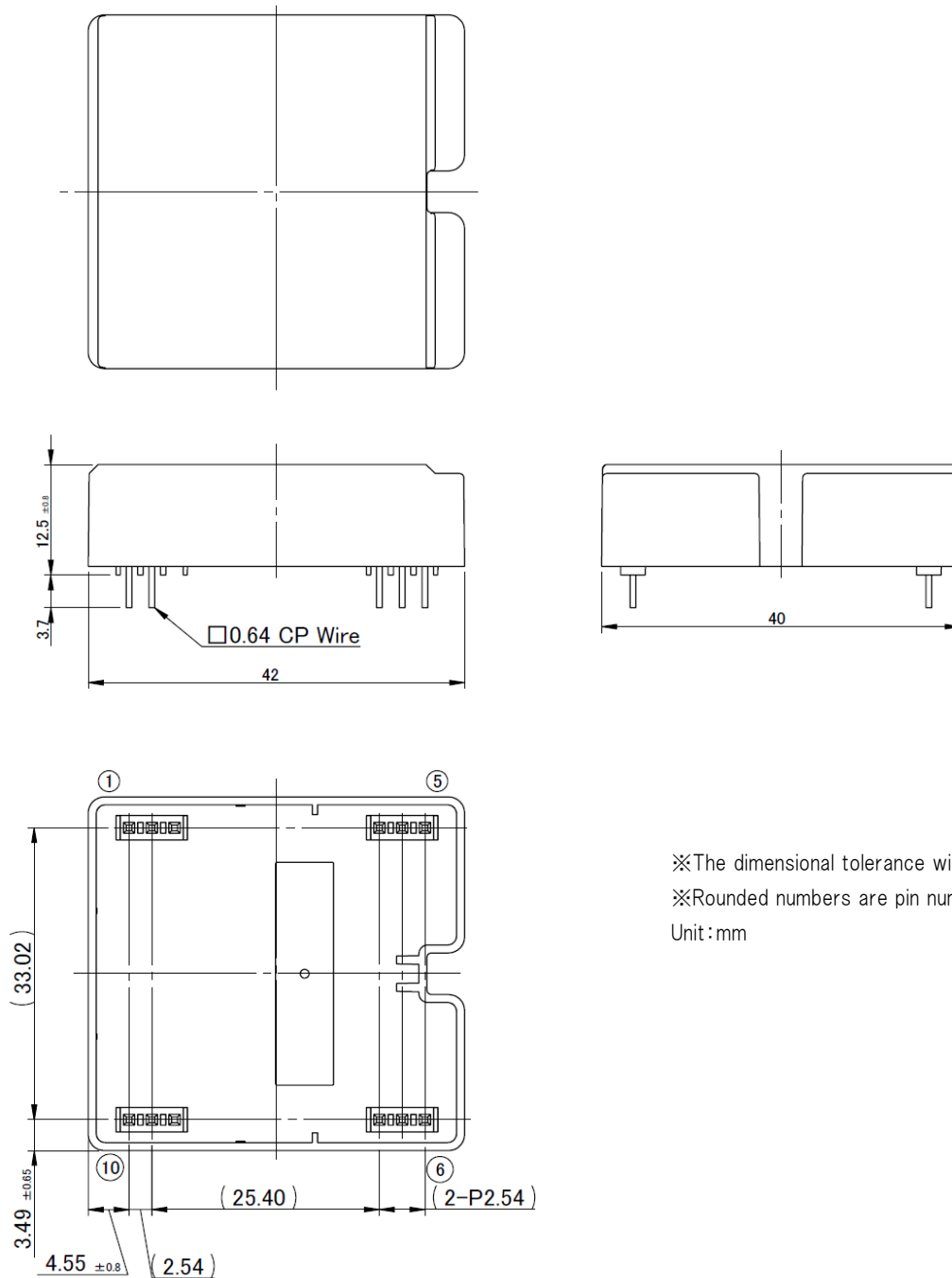

※The dimensional tolerance without directions is ± 0.5 mm.
 ※Rounded numbers are pin numbers.
 Unit : mm

■Product Weight

30g(TYP)

■ Recommended hole diameter and land size

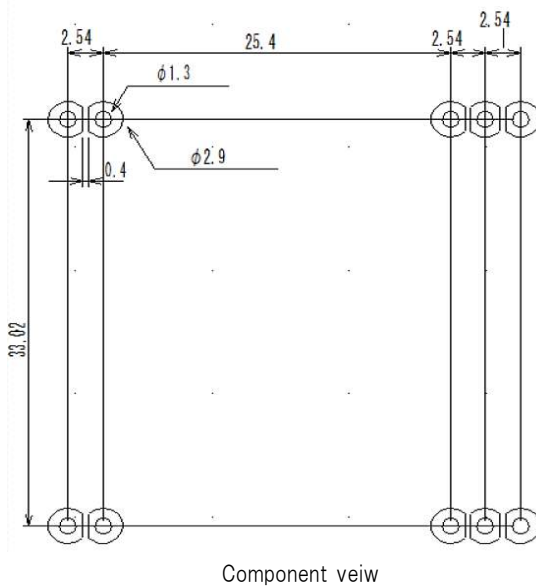

※ 1pin and 2pin are connected by providing land.
Mechanical strength may decrease.

Unit: mm

■ Recommended Soldering Condition

- Flow solder conditions : 255±3°C 5sec or less
Preheat temperature 110°C~130°C
Preheat end 110°C±10°C
- Soldering condition of hand work : 350°C(MAX) 4sec or less

■ Storage condition

Item	Min	Max	Unit	Conditions·Note
Storage temperature	-25	60	°C	Packing condition

※If you want to use past the long period there is a concern that the solder non-wetting by terminal oxidation to occur.
Therefore, please use from taking enough tests.

■ Usage Cautions

- Always mount fuse on the plus side of input for ensuring safety because the fuse is not built-in the product.
Please select the fuse considering conditions such as steady current, inrush current, and ambient temperature.
When using a fuse having large rated current or high capacity input electrolytic condenser, by combining another converter and input line and input electrolytic condenser, fuse may not blow off in the case of abnormality.
Do not combine high voltage line and fuse.
- The output voltage accuracy may be affected by the COM sink current.
If you want to maintain the accuracy of the output voltage, adjust the current value between VO+~COM and COM~Vo- by adding a resistor or the like so that the current value is the same between VO+~COM and COM~VO-.

■ Important Notice

- The content of this information is subject to change without prior notice for the purpose of improvements, etc. Ensure that you are in possession of the most up-to-date information when using this product.
- The operation examples and circuit examples shown in this document are for reference purposes only, and TAMURA Corporation disclaims all responsibility for any violations of industrial property rights, intellectual property rights and any other rights owned by TAMURA Corporation or third parties that these may entail.
- The circuit examples and part constants listed in this document are provided as reference for the verification of characteristics. You are to perform design, verification, and judgment at your own responsibility, taking into account the various conditions.
- TAMURA has evaluated the efficiency and performance of this product in a usage environment determined by us. Depending on your usage environment or usage method, there is the possibility that this product will not perform sufficiently as shown in the specifications, or may malfunction.
When applying this product to your devices or systems, please ensure that you conduct evaluations of their state when integrated with this product. You are responsible for judging its applicability.
TAMURA bears no responsibility whatsoever for any problems with your devices, systems or this product which are caused by your usage environment or usage method.
- TAMURA Corporation constantly strives to improve quality and reliability, but malfunction or failures are bound to occur with some probability in power products. To ensure that failures do not cause accidents resulting in injury or death, fire accidents, social damage, and so on, you are to thoroughly verify the safety of their designs in devices and/or systems, at your own responsibility.
- This product is intended for use in consumer electronics (electric home appliances, business equipment, information equipment, communication terminal equipment, measuring devices, and so on.) If considering use of this product in equipment or devices that require high reliability (medical devices, transportation equipment, traffic signal control equipment, fire and crime prevention equipment, aeronautics and space devices, nuclear power control, fuel control, in-vehicle equipment, safety devices, and so on), please consult a TAMURA sales representative in advance. Do not use this product for such applications without written permission from TAMURA Corporation.
- This product is intended for use in environments where consumer electronics are commonly used. It is not designed for use in special environments such as listed below, and if such use is considered, you are to perform thorough safety and reliability checks at your own responsibility.
 - Use in liquids such as water, oil, chemical solutions, or organic solvents, and use in locations where the product will be exposed to such liquids.
 - Use that involves exposure to direct sunlight, outdoor exposure, or dusty conditions.
 - Use in locations where corrosive gases such as salt air, C12, H2S, NH3, SO2, or NO2, are present.
 - Use in environments with strong static electricity or electromagnetic radiation.
 - Use that involves placing inflammable material next to the product.
 - Use of this product either sealed with a resin filling or coated with resin.
 - Use of water or a water soluble detergent for flux cleaning.
 - Use in locations where condensation is liable to occur.
- This product is not designed to resist radiation.
- This product is not designed to be connected in series or parallel.
Do not operate this product in a series, parallel, or N+1 redundant configuration.
- Do not use or otherwise make available the TAMURA products or the technology described in this document for any military purposes, including without limitation, for the design, development, use, stockpiling or manufacturing of mass destruction weapons (e.g. nuclear, chemical, or biological weapons or missile technology products).
When exporting and re-exporting the products or technology described in this document, you should comply with the applicable export control laws and regulations and follow the procedures required by such laws and regulations including, without limitation, Japan -Foreign Exchange and Foreign Trade Control Law and U.S.- Export Administration Regulations.
The TAMURA products and related technology should not be used for or incorporated into any products or systems whose manufacture, use, or sale is prohibited under any applicable domestic or foreign laws or regulations.
- Please contact your TAMURA sales office for details as to environmental matters such as the RoHS compatibility of product. Please use TAMURA products in compliance with all applicable laws and regulations that regulate the inclusion or use of controlled substances, including without limitation, the EU RoHS Directive.
TAMURA assumes no liability for damages or losses occurring as a result of your noncompliance with applicable laws and regulations.
- TAMURA assumes no liability for damages or losses incurred by you or third parties as a result of unauthorized use of TAMURA products.
- This document and any information herein may not be reproduced in whole or in part without prior written permission from TAMURA.