

TPS798xx-Q1 50 mA, 3 V to 50 V, Micropower, Low-Dropout Linear Regulator

1 Features

- Qualified for Automotive Applications
- Wide Input Voltage Range: 3 V to 50 V
- Low Quiescent Current: 40 μ A (Typical)
- Low Dropout Voltage: 300 mV (Typical)
- Output Current: 50 mA
- No Input Protection Diodes Needed
- Adjustable Output From 1.275 V to 28 V
- 1- μ A Quiescent Current in Shutdown
- Stable With 1- μ F Output Capacitor
- Stable With Aluminum, Tantalum, or Ceramic Capacitors
- Reverse Input-Battery Protection
- Reverse Output Current Flow Protection
- Thermal Limiting
- Available in an 8-Pin MSOP-PowerPAD IC Package

2 Applications

- Low-Current, High-Voltage Regulators
- Regulators for Battery-Powered Systems
- Telecom
- Automotives

3 Description

The TPS798xx-Q1 is the first device in a line of 50-V high-voltage micropower low-dropout (LDO) linear regulators. This device is capable of supplying 50-mA output current with a dropout voltage of only 300 mV. Designed for low quiescent current high voltage (50 V) applications, 40 μ A operating and 1 μ A in shutdown makes the TPS798xx-Q1 an ideal choice for battery-powered or high-voltage systems. Quiescent current is also well-controlled in dropout.

Other features of the TPS798xx-Q1 include the ability to operate with low equivalent series resistance (ESR) ceramic output capacitors. This device is stable with only 1 μ F on the output; most older devices require from 10- μ F to 100- μ F tantalum capacitors for stability. Small ceramic capacitors can be used without the necessary addition of ESR, as is common with other regulators. Internal protection circuitry includes reverse input-battery protection, reverse output current protection, current limiting, and thermal limiting to protect the device in various fault conditions.

This device is available in a fixed output voltage of 5 V (TPS79850) and with an adjustable output voltage with a 1.275-V reference voltage (TPS79801). The TPS798xx-Q1 regulator is available in a 8-pin MSOP-PowerPAD (DGN) package with an exposed pad for enhanced thermal management capability.

Device Information⁽¹⁾

PART NUMBER	PACKAGE	BODY SIZE (NOM)
TPS79801-Q1	MSOP-PowerPAD (8)	3.00 mm × 3.00 mm
TPS79850-Q1		

(1) For all available packages, see the orderable addendum at the end of the data sheet.

Simplified Schematic

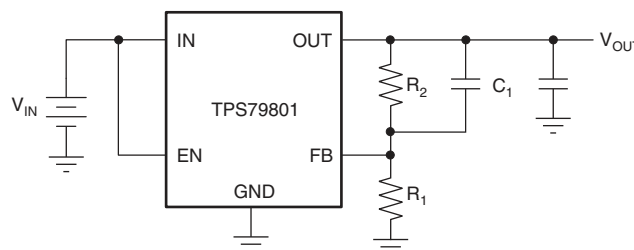

$$V_{OUT} = 1.275 \text{ V} (1 + R_2 / R_1) + I_{FB} R_2$$

$$V_{FB} = 1.275 \text{ V}$$

$$I_{FB} = 0.2 \mu\text{A at } 25^\circ\text{C}$$

$$\text{Output Range} = 1.275 \text{ V to } 28 \text{ V}$$



Table of Contents

1 Features 1 2 Applications 1 3 Description 1 4 Revision History 2 5 Pin Configuration and Functions 3 6 Specifications 3 6.1 Absolute Maximum Ratings 3 6.2 ESD Ratings..... 3 6.3 Recommended Operating Conditions 4 6.4 Thermal Information 4 6.5 Electrical Characteristics..... 5 6.6 Dissipation Ratings 6 6.7 Typical Characteristics 7 7 Detailed Description 9 7.1 Overview 9 7.2 Functional Block Diagram 9 7.3 Feature Description..... 10	7.4 Device Functional Modes..... 12 8 Application and Implementation 13 8.1 Application Information..... 13 8.2 Typical Application 13 9 Power Supply Recommendations 15 9.1 Thermal Considerations 15 10 Layout 15 10.1 Layout Guidelines 15 10.2 Layout Example 15 10.3 Thermal Considerations 15 11 Device and Documentation Support 17 11.1 Related Links 17 11.2 Community Resources..... 17 11.3 Trademarks 17 11.4 Electrostatic Discharge Caution..... 17 11.5 Glossary 17 12 Mechanical, Packaging, and Orderable Information 17
--------------------------------------------------------------------------------------------------------------------------------------------------------------------------------------------------------------------------------------------------------------------------------------------------------------------------------------------------------------------------------------------------------------------------------------------------------------------------------------------------------------------------------------------------------------------------------------------------------------------------------------------	------------------------------------------------------------------------------------------------------------------------------------------------------------------------------------------------------------------------------------------------------------------------------------------------------------------------------------------------------------------------------------------------------------------------------------------------------------------------------------------------------------------------------------------------------------------------------------------------------------------------------------------------------------------------------------------------------------

4 Revision History

NOTE: Page numbers for previous revisions may differ from page numbers in the current version.

Changes from Revision D (August 2011) to Revision E	Page
<ul style="list-style-type: none"> • Added <i>Pin Configuration and Functions</i> section, <i>ESD Ratings</i> table, <i>Feature Description</i> section, <i>Device Functional Modes</i>, <i>Application and Implementation</i> section, <i>Power Supply Recommendations</i> section, <i>Layout</i> section, <i>Device and Documentation Support</i> section, and <i>Mechanical, Packaging, and Orderable Information</i> section 1 	1

5 Pin Configuration and Functions

DGN Package
8-Pin MSOP With PowerPAD™
Top View

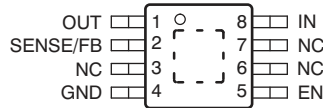

The exposed thermal pad is connected to ground through pin 4 (GND).

Pin Functions

PIN		I/O	DESCRIPTION
NAME	NO.		
EN	5	I	Enable pin. Driving the EN pin high turns on the regulator over full operating range. Driving this pin low puts the regulator into shutdown mode over full operating range.
IN	8	I	Input pin. TI recommends a 0.1- μ F ceramic or greater capacitor from this pin to ground to assure stability. Both input and output capacitor grounds should be tied back to the IC ground with no significant impedance between them.
GND	4	O	Ground. The exposed thermal pad is connected to ground through this pin.
OUT	1	O	Regulated output voltage pin. A small (1 μ F) capacitor is needed from this pin to ground to assure stability.
SENSE/FB	2	I	This pin is the input to the control loop error amplifier; it is used to set the output voltage of the device.
NC	3, 6, 7	—	No internal connection

6 Specifications

6.1 Absolute Maximum Ratings

over operating free-air temperature range (unless otherwise noted)⁽¹⁾

		MIN	MAX	UNIT
V_{IN} Input voltage range	IN ⁽²⁾	-65	60	V
	OUT	-0.3	28	V
	FB	-0.3	7	V
	EN ⁽²⁾	-65	60	V
	Enable to IN differential	0.6	V_{IN}	V
T_J Junction temperature range ⁽³⁾		-40	125	°C
T_{stg} Storage temperature		-65	150	°C

- (1) Stresses beyond those listed under *Absolute Maximum Ratings* may cause permanent damage to the device. These are stress ratings only, which do not imply functional operation of the device at these or any other conditions beyond those indicated under *Recommended Operating Conditions*. Exposure to absolute-maximum-rated conditions for extended periods may affect device reliability.
- (2) Transient: 500 ms for $V_{IN} > 50$ V
- (3) The junction temperature must not exceed 125°C. See [Figure 1](#) to determine the maximum ambient operating temperature versus the supply voltage and load current. The safe operating area curves assume a 50°C/W thermal impedance and may need to be adjusted to match actual system thermal performance.

6.2 ESD Ratings

		VALUE	UNIT
$V_{(ESD)}$ Electrostatic discharge	Human body model (HBM), per AEC Q100-002 ⁽¹⁾	± 2000	V
	Charged device model (CDM), per AEC Q100-011	± 1000	

- (1) AEC Q100-002 indicates HBM stressing is done in accordance with the ANSI/ESDA/JEDEC JS-001 specification.

6.3 Recommended Operating Conditions

		MIN	MAX	UNIT	
V_{IN}	Input voltage	IN	-65	50	V
		OUT	-0.3	28	
		FB	-0.3	7	
		EN	-65	50	
I_{OUT}	Output current		50	mA	
T_J	Operating junction temperature ^{(1) (2) (3)}	-40	125	°C	
T_A	Ambient free-air temperature	-40	105	°C	

- (1) Operating conditions are limited by maximum junction temperature. The regulated output voltage specification does not apply for all possible combinations of input voltage and output current. When operating at maximum input voltage, the output current range must be limited. When operating at maximum output current, the input voltage range must be limited.
- (2) The TPS798xx-Q1 is specified to meet performance specifications from -40°C to 125°C operating junction temperature. Specifications over the full operating junction temperature range are specified by design, characterization, and correlation with statistical process controls.
- (3) This device includes overtemperature protection that is intended to protect the device during momentary overload conditions. Junction temperature exceeds 125°C (minimum) when overtemperature protection is active. Continuous operation above the specified maximum operating junction temperature may impair device reliability.

6.4 Thermal Information

THERMAL METRIC ⁽¹⁾		TPS79801-Q1, TPS79850-Q1	
		DGN (MSOP-PowerPAD)	
		8 PINS	
			UNIT
$R_{\theta JA}$	Junction-to-ambient thermal resistance (JEDEC 51-5 ⁽²⁾)	57.1	°C/W
	Junction-to-ambient thermal resistance (JEDEC 51-7 ⁽³⁾)	130	°C/W
$R_{\theta JC(top)}$	Junction-to-case (top) thermal resistance	50.3	°C/W
$R_{\theta JB}$	Junction-to-board thermal resistance	30.6	°C/W
Ψ_{JT}	Junction-to-top characterization parameter	1.5	°C/W
Ψ_{JB}	Junction-to-board characterization parameter	30.3	°C/W
$R_{\theta JC(bot)}$	Junction-to-case (bottom) thermal resistance	6.5	°C/W

- (1) For more information about traditional and new thermal metrics, see the *Semiconductor and IC Package Thermal Metrics* application report, [SPRA953](#).
- (2) The thermal data is based on using JEDEC 51-5. The copper pad is soldered to the thermal land pattern and using 5 by 8 thermal array (vias). Correct attachment procedure must be incorporated.
- (3) The thermal data is based on using JEDEC 51-7. The copper pad is soldered to the thermal land. No thermal vias. Correct attachment procedure must be incorporated.

6.5 Electrical Characteristics

$V_{IN} = V_{OUT(NOM)} + 1\text{ V}$ or 4 V (whichever is greater for either fixed or adjustable versions), $I_{LOAD} = 1\text{ mA}$, $V_{EN} = 3\text{ V}$, $C_{OUT} = C_{IN} = 2.2\text{ }\mu\text{F}$ (unless otherwise noted). For TPS79801, FB pin tied to V_{OUT} . Typical values are at $T_J = 25^\circ\text{C}$.

PARAMETER		TEST CONDITIONS		$T_J^{(1)}$	MIN	TYP	MAX	UNIT		
V_{IN}	Minimum input voltage	$I_{LOAD} = 50\text{ mA}$		Full range		3	4	V		
Fixed V_{OUT}	Initial output voltage accuracy	$V_{IN} = V_{OUT\text{ nom}} + 0.5\text{ V}$		25°C	-1.5%		1.5%			
	Output voltage accuracy over line, load, and full temperature range	$V_{IN} = V_{OUT\text{ nom}} + 1\text{ V to }50\text{ V}$, $I_{LOAD} = 1\text{ mA to }50\text{ mA}$		Full range	-3%		3%			
Adjustable V_{OUT}	Initial output voltage accuracy	$V_{IN} = 3\text{ V}$		25°C	1.256	1.275	1.294	V		
	Output voltage accuracy over line, load, and full temperature range	$V_{IN} = 4\text{ V to }50\text{ V}$, $I_{LOAD} = 1\text{ mA to }50\text{ mA}$		Full range	1.237	1.275	1.313	V		
$\Delta V_{OUT}/\Delta V_{IN}$	Line regulation, adjustable V_{OUT}	$\Delta V_{IN} = 3\text{ V to }50\text{ V}$		Full range				13	mV	
	Line regulation, TPS79850	$V_{IN} = V_{OUT\text{ nom}} + 0.5\text{ V to }50\text{ V}$						15	mV	
$\Delta V_{OUT}/\Delta I_{OUT}$	Load regulation, adjustable V_{OUT}	$\Delta I_{LOAD} = 1\text{ mA to }50\text{ mA}$		25°C				20	mV	
				Full range				32		
	Load regulation, fixed V_{OUT}	$\Delta I_{LOAD} = 1\text{ mA to }50\text{ mA}$		25°C				50	mV	
				Full range				90		
Adjustable V_{OUT}	Output voltage range ^{(2) (3)}			Full range	1.275		28	V		
V_{DO}	Dropout voltage ^{(4) (5)}	$V_{IN} = V_{OUT(NOM)} - 0.1\text{ V}$		25°C				85	150	
				Full range				190		
		$I_{LOAD} = 10\text{ mA}$, $V_{IN} = V_{OUT(NOM)} - 0.1\text{ V}$		25°C				170	260	
				Full range				350		
$I_{LOAD} = 50\text{ mA}$, $V_{IN} = V_{OUT(NOM)} - 0.1\text{ V}$		25°C				300	370			
		Full range				550				
I_{GND}	GND pin current ⁽⁶⁾	$V_{IN} = V_{OUT(NOM)}$		$I_{LOAD} = 0\text{ mA}$	Full range			30	80	
				$I_{LOAD} = 1\text{ mA}$	Full range			100		180
				$I_{LOAD} = 10\text{ mA}$	Full range			400	700	
				$I_{LOAD} = 50\text{ mA}$	Full range			1.8		3.3
V_N	Output voltage noise	$C_{OUT} = 10\text{ }\mu\text{F}$, $I_{LOAD} = 50\text{ mA}$, $BW = 10\text{ Hz to }100\text{ kHz}$, $V_{IN} = 4.3\text{ V}$, $V_{OUT} = 3.3\text{ V}$ (adjustable used)		25°C				100	μV_{RMS}	
I_{FB}	FB pin bias current ⁽⁷⁾	$V_{IN} = 3\text{ V}$		25°C				0.05	0.2	μA
V_{EN}	EN pin high (enabled) ⁽⁸⁾	OFF to ON, $V_{IN} = 6\text{ V}$		Full range				1.5	V	
	EN pin low (shutdown) ⁽⁸⁾	ON to OFF, $V_{IN} = 6\text{ V}$		25°C	0.4 V				V	
	EN pin low (shutdown) ⁽⁸⁾	ON to OFF, $V_{IN} = 6\text{ V}$		Full range	0.2 V				V	
I_{EN}	EN pin current ⁽⁸⁾	$V_{EN} = 0\text{ V}$, $V_{IN} = 6\text{ V}$, $I_{LOAD} = 0\text{ mA}$		Full range	0.4			2	μA	
		$V_{EN} = 3\text{ V}$, $V_{IN} = 6\text{ V}$, $I_{LOAD} = 0\text{ mA}$		Full range	0.4			0.5		
$I_{shutdown}$	GND pin current ⁽⁶⁾	$V_{IN} = 6\text{ V}$, $V_{EN} = 0\text{ V}$, $I_{LOAD} = 0\text{ mA}$		Full range	3			25	μA	
PSRR	Power-supply rejection ratio	$V_{IN} = 4.3\text{ V}$, $V_{OUT} = 3.3\text{-V}$, $V_{RIPPLE} = 0.5\text{ V}_{PP}$, $f_{RIPPLE} = 120\text{ Hz}$, $I_{LOAD} = 50\text{ mA}$		25°C	65				dB	
I_{LIMIT}	Fixed current limit ⁽⁹⁾	$\Delta V_{OUT} = V_{OUT(NOM)} - 0.1\text{ V}$		Full range	60			200	mA	
	Adjustable current limit	$\Delta V_{OUT} = V_{OUT(NOM)} - 0.1\text{ V}$		Full range	60			200	mA	

(1) Full range $T_J = -40^\circ\text{C}$ to 125°C

(2) This parameter is tested and specified under pulse load conditions such that $T_J = T_A$. This device is 100% production tested at $T_A = 25^\circ\text{C}$. Performance at full range is specified by design, characterization, bench to ATE correlation testing, and other statistical process controls.

(3) This device is limited by a maximum junction temperature of $T_J = 125^\circ\text{C}$. The regulated output voltage specification cannot be applied to all combinations of various V_{IN} , V_{OUT} , ambient temperature, and I_{OUT} conditions. When operating with large voltage differentials across the device, the output load must be limited so as not to violate the maximum junction temperature for a given ambient temperature.

(4) In the adjustable version test, the output uses an external voltage divider. This resistor voltage divider is made up of $R_1 = 215\text{ k}\Omega$ and R_2 (bottom resistor) = $340\text{ k}\Omega$. This configuration preloads the output with $6\text{ }\mu\text{A}$.

(5) By definition, dropout voltage is the minimum input voltage needed to maintain a given output voltage at a specific load current. For dropout testing, minimum $V_{IN} = V_{OUT(NOM)} \times 0.96$. This specification ensures that the device is in dropout and takes into account the output voltage tolerance over the full temperature range.

(6) Ground pin current is tested with $V_{IN} = V_{OUT(NOM)}$ or 3 V , whichever is greater.

(7) FB pin current flows into the FB pin.

(8) EN pin current flows into the EN pin.

(9) Current limit is tested with $V_{IN} = V_{OUT(NOM)} + 0.5\text{ V}$ or 3 V , whichever is greater. V_{OUT} is forced to $V_{OUT(NOM)} - 0.1\text{ V}$ and the output current is measured.

Electrical Characteristics (continued)

$V_{IN} = V_{OUT(NOM)} + 1\text{ V}$ or 4 V (whichever is greater for either fixed or adjustable versions), $I_{LOAD} = 1\text{ mA}$, $V_{EN} = 3\text{ V}$, $C_{OUT} = C_{IN} = 2.2\text{ }\mu\text{F}$ (unless otherwise noted). For TPS79801, FB pin tied to V_{OUT} . Typical values are at $T_J = 25^\circ\text{C}$.

PARAMETER	TEST CONDITIONS	$T_J^{(1)}$	MIN	TYP	MAX	UNIT		
I_{RL}	Input reverse leakage current (reverse battery test)	$V_{IN} = -60\text{ V}$, $V_{OUT} = \text{open}$, C_{IN} open	Full range			6	mA	
I_{RO}	Reverse output current ⁽¹⁰⁾	$V_{OUT} = V_{OUT(NOM)}$, $V_{IN} = \text{ground}$	25°C			19	25	μA
T_{SD}	Thermal shutdown temperature (T_J) ⁽¹¹⁾	Shutdown, temperature increasing	135			°C		
		Reset, temperature decreasing	135					

(10) Reverse output current is tested with the IN pin tied to ground and the output forced to $V_{OUT(NOM)} + 0.1\text{ V}$. This current flows into the OUT pin and out of the GND pin and then measured.

(11) Specified by design

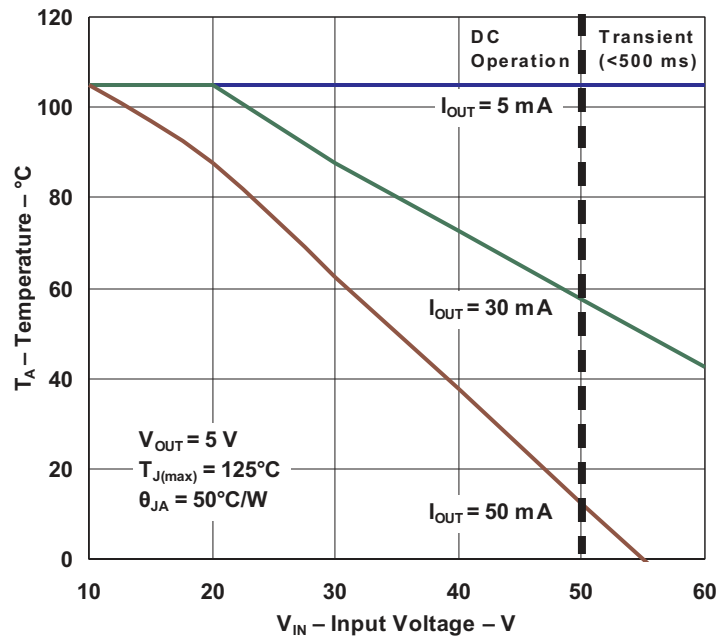

Figure 1. Safe Operating Area

6.6 Dissipation Ratings⁽¹⁾

BOARD	PACKAGE	DERATING FACTOR ABOVE $T_A = 25^\circ\text{C}$	$T_A \leq 25^\circ\text{C}$ POWER RATING	$T_A = 70^\circ\text{C}$ POWER RATING	$T_A = 85^\circ\text{C}$ POWER RATING
High-K ⁽²⁾	DGN	16.6 mW/°C	1.83 W	1.08 W	0.833 W

(1) See [Thermal Considerations](#) for more information related to thermal design.

(2) The JEDEC High-K (1s) board design used to derive this data was a 4.5-inch \times 3-inch, 2-layer board with 2-ounce copper traces on top of the board.

6.7 Typical Characteristics

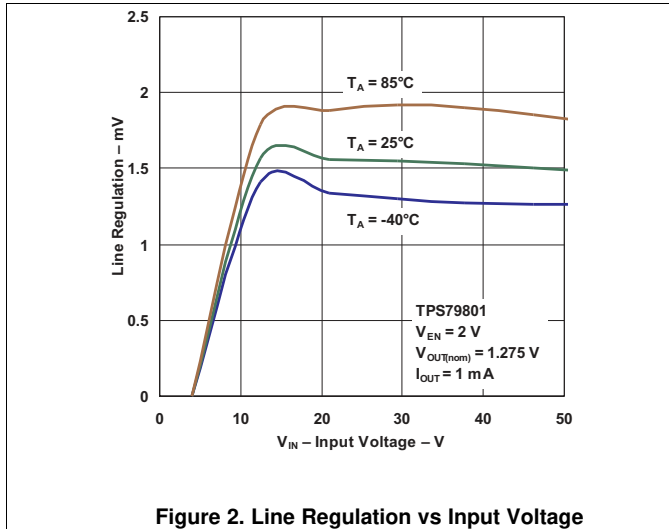

Figure 2. Line Regulation vs Input Voltage

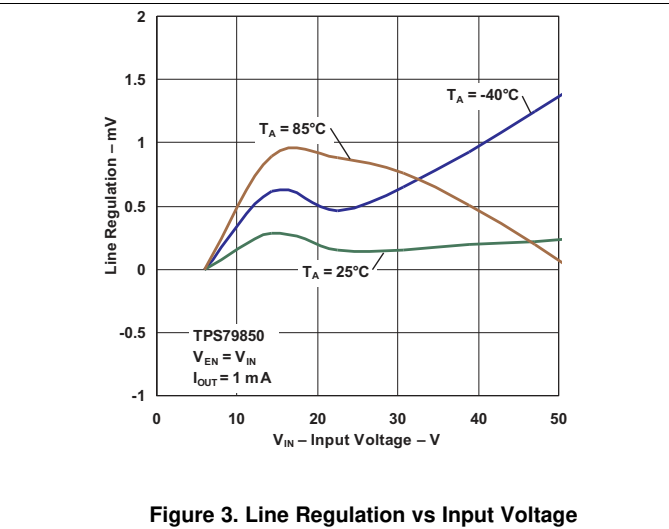

Figure 3. Line Regulation vs Input Voltage

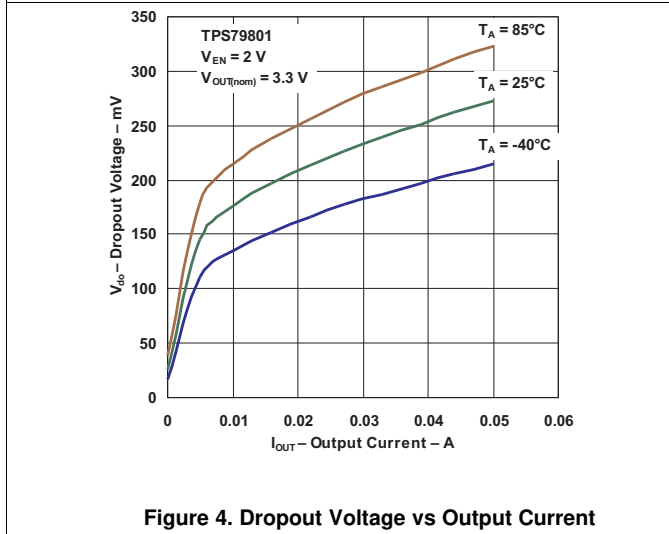

Figure 4. Dropout Voltage vs Output Current

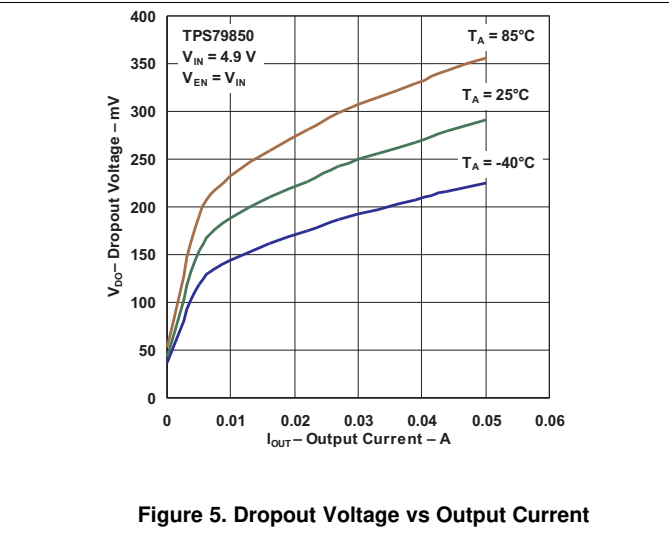

Figure 5. Dropout Voltage vs Output Current

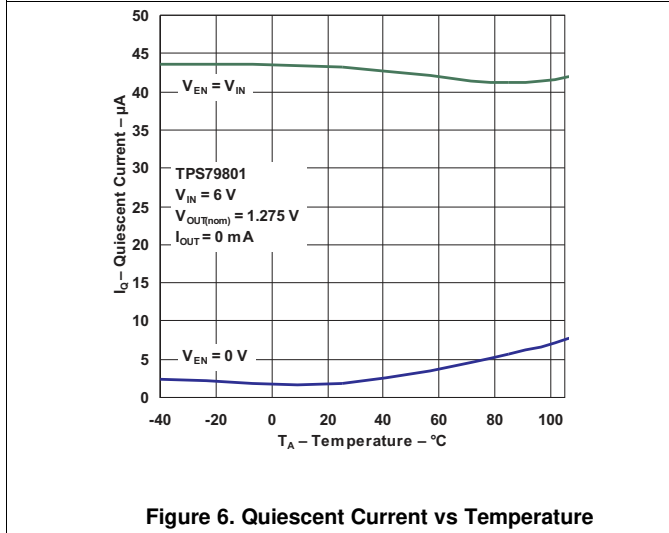

Figure 6. Quiescent Current vs Temperature

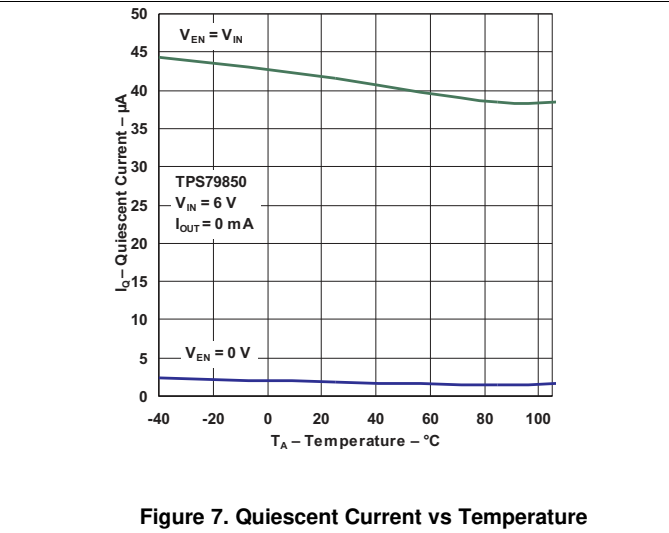

Figure 7. Quiescent Current vs Temperature

Typical Characteristics (continued)

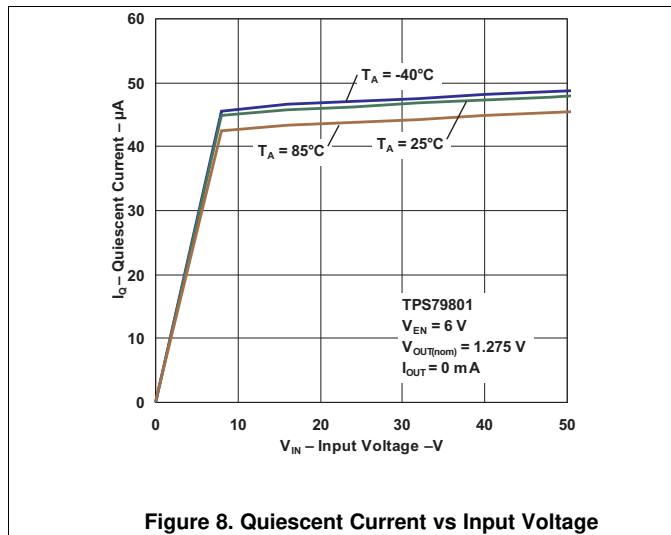

Figure 8. Quiescent Current vs Input Voltage

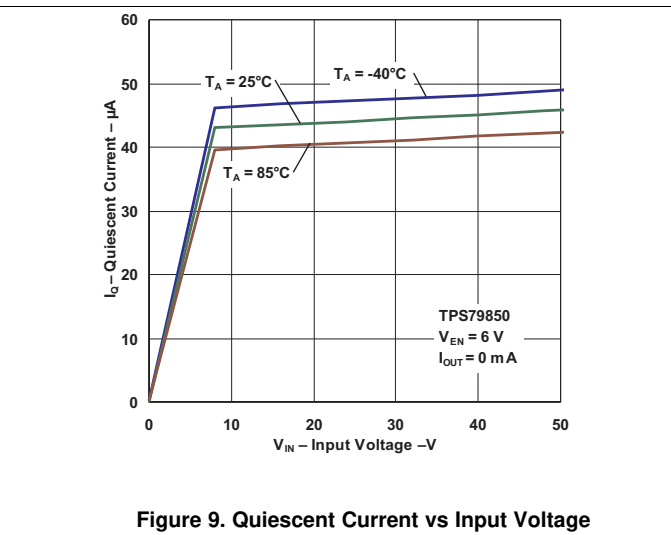

Figure 9. Quiescent Current vs Input Voltage

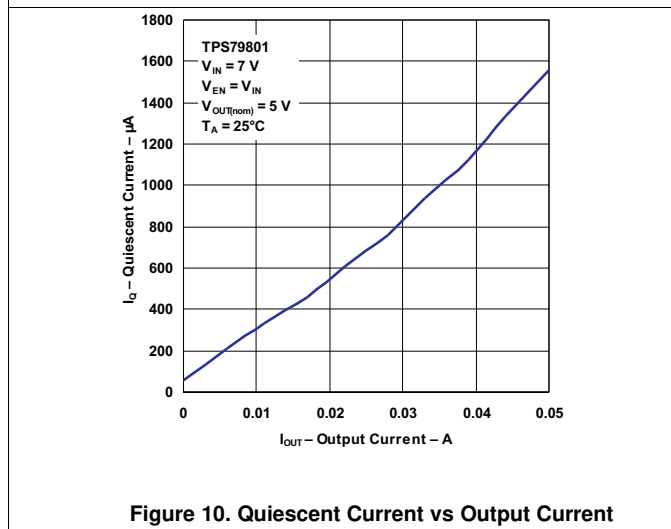

Figure 10. Quiescent Current vs Output Current

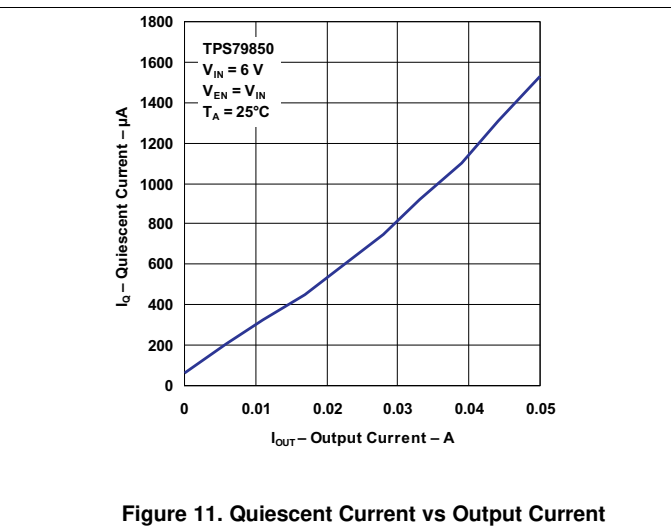

Figure 11. Quiescent Current vs Output Current

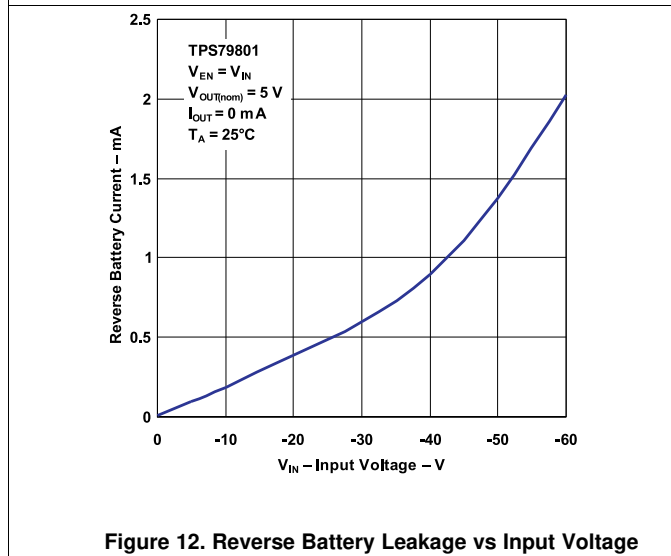

Figure 12. Reverse Battery Leakage vs Input Voltage

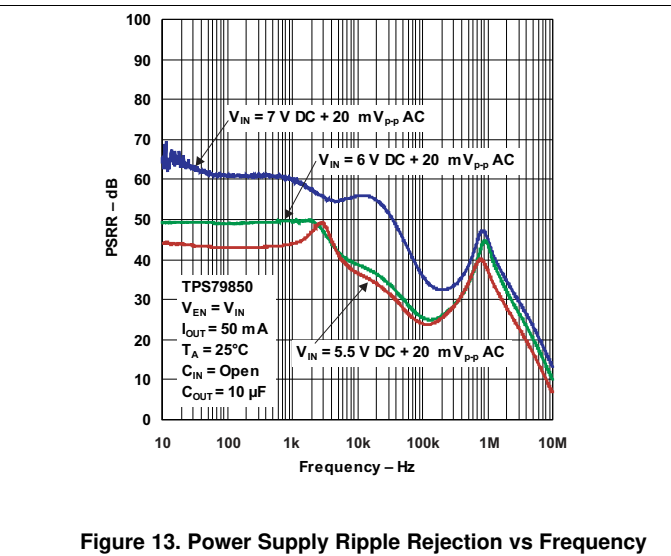

Figure 13. Power Supply Ripple Rejection vs Frequency

7 Detailed Description

7.1 Overview

The TPS798xx-Q1 is a 50-mA high-voltage LDO regulator with micropower quiescent current and shutdown. The device is capable of supplying 50 mA at a dropout voltage of 300 mV (typical). The low operating quiescent current (40 μ A) drops to 1 μ A in shutdown. In addition to the low quiescent current, the TPS798xx-Q1 incorporates several protection features that make it ideal for battery-powered applications.

The device is protected against both reverse-input and reverse-output voltages. In battery-backup applications, where the output can be held up by a backup battery when the input is pulled to ground, the TPS798xx-Q1 acts as if it has a diode in series with its output and prevents reverse current flow. Figure 14 and Figure 15 illustrate two typical applications.

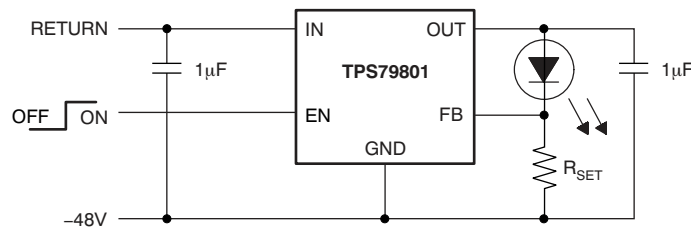

$$I_{LED} = 1.275 \text{ V}/R_{SET}$$

-48 V can vary from -4 V to -50 V

Figure 14. Constant Brightness for Indicator LED Over Wide Input Voltage Range

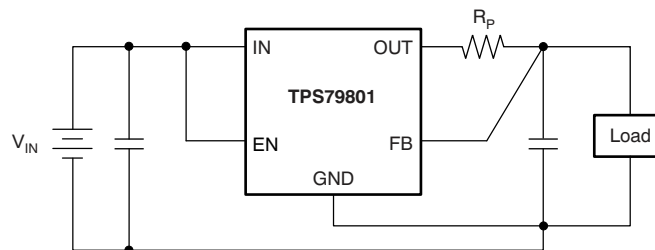

Figure 15. Kelvin Sense Connection

7.2 Functional Block Diagram

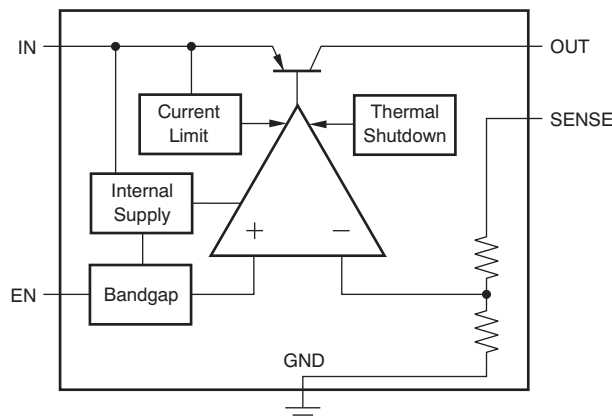

Figure 16. Fixed Voltage Output Version

Functional Block Diagram (continued)

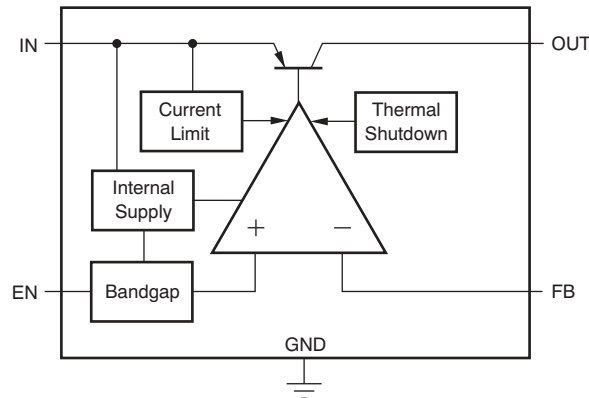
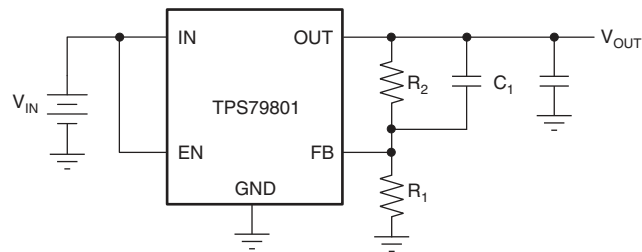

Figure 17. Adjustable Voltage Output Version

7.3 Feature Description

7.3.1 Adjustable Operation

The TPS798xx-Q1 has an output voltage range of 1.275 V to 28 V. The output voltage is set by the ratio of two external resistors as shown in Figure 18. The feedback loop monitors the output to maintain the voltage at the adjust pin at 1.275 V referenced to ground. The current in R_1 is then equal to $1.275 \text{ V}/R_1$, and the current in R_2 is the current in R_1 plus the FB pin bias current. The FB pin bias current, $0.2 \mu\text{A}$ at 25°C , flows through R_2 into the FB pin. The output voltage can be calculated using the formula in Figure 18. The value of R_1 should be less than $250 \text{ k}\Omega$ to minimize errors in the output voltage caused by the FB pin bias current. Note that in shutdown, the output is turned off and the divider current is zero.



$$V_{\text{OUT}} = 1.275 \text{ V} \left(1 + \frac{R_2}{R_1} \right) + I_{\text{FB}} R_2$$

$$V_{\text{FB}} = 1.275 \text{ V}$$

$$I_{\text{FB}} = 0.2 \mu\text{A at } 25^\circ\text{C}$$

$$\text{Output Range} = 1.275 \text{ V to } 28 \text{ V}$$

Figure 18. Adjustable Operation

A 100-pF capacitor (C_1) placed in parallel with the top resistor (R_2) of the output divider is necessary for stability and transient performance of the adjustable TPS798xx-Q1. The impedance of C_1 at 10 kHz should be less than the value of R_2 .

The adjustable device is tested and specified with the FB pin tied to the OUT pin and a 1 mA-DC load (unless otherwise specified) for an output voltage of 1.275 V . Specifications for output voltages greater than 1.275 V are proportional to the ratio of the desired output voltage to 1.275 V ($V_{\text{OUT}}/1.275 \text{ V}$). For example, load regulation for an output current change of 1 mA to 50 mA is -10 mV (typical) at $V_{\text{OUT}} = 1.275 \text{ V}$.

At $V_{\text{OUT}} = 12 \text{ V}$, load regulation is:

$$(12 \text{ V}/1.275 \text{ V}) \times (-10 \text{ mV}) = -94 \text{ mV} \quad (1)$$

Feature Description (continued)

7.3.2 Output Capacitance and Transient Response

The TPS798xx-Q1 is designed to be stable with a wide range of output capacitors. The ESR of the output capacitor affects stability, most notably with small capacitors. To prevent oscillations, TI recommends a minimum output capacitor of 1 μF with an ESR of 3 Ω or less. The TPS798xx-Q1 is a micropower device, and output transient response is a function of output capacitance. Larger values of output capacitance decrease the peak deviations and provide improved transient response for larger load current changes. Bypass capacitors, used to decouple individual components powered by the TPS798xx-Q1, increase the effective output capacitor value.

Extra consideration must be given to the use of ceramic capacitors. Ceramic capacitors are manufactured with a variety of dielectrics, each with different behavior over temperature and applied voltage. The most common dielectrics used are Z5U, Y5 V, X5R, and X7R. The Z5U and Y5 V dielectrics are good for providing high capacitances in a small package, but exhibit strong voltage and temperature coefficients. When used with a 5 V regulator, a 10- μF Y5 V capacitor can exhibit an effective value as low as 1 μF to 2 μF over the operating temperature range. The X5R and X7R dielectrics result in more stable characteristics and are more suitable for use as the output capacitor. The X7R type has better stability across temperature, while the X5R is less expensive and is available in higher values.

Voltage and temperature coefficients are not the only sources of problems. Some ceramic capacitors have a piezoelectric response. A piezoelectric device generates voltage across its terminals because of mechanical stress, similar to the way a piezoelectric accelerometer or microphone works. For a ceramic capacitor, the stress can be induced by vibrations in the system or thermal transients.

7.3.3 Calculating Junction Temperature

Given an output voltage of 5 V, an input voltage range of 15 V to 24 V, an output current range of 0 mA to 50 mA, and a maximum ambient temperature of 50°C, the maximum junction temperature is calculated as follows.

The power dissipated (P_{DISS}) by the DGN package is equal to:

$$I_{\text{OUT(MAX)}}(V_{\text{IN(MAX)}} - V_{\text{OUT}}) + I_{\text{GND}}(V_{\text{IN(MAX)}})$$

where

- $I_{\text{OUT(MAX)}} = 50 \text{ mA}$
 - $V_{\text{IN(MAX)}} = 24 \text{ V}$
 - $V_{\text{OUT}} = 5 \text{ V}$
 - I_{GND} at ($I_{\text{OUT}} = 50 \text{ mA}$, $V_{\text{IN}} = 24 \text{ V}$) = 1 mA
- (2)

Therefore,

$$P_{\text{DISS}} = 50 \text{ mA} (24 \text{ V} - 5 \text{ V}) + 1 \text{ mA} (24 \text{ V}) = 0.974 \text{ W}$$
(3)

The thermal resistance is approximately 60°C/W, based on JEDEC 51-5 profile. Therefore, the junction temperature rise above ambient is approximately equal to:

$$0.974 \text{ W} \times 60^\circ\text{C/W} = 58.44^\circ\text{C}$$
(4)

The maximum junction temperature is then equal to the maximum junction temperature rise above ambient plus the maximum ambient temperature or:

$$T_{\text{J max}} = 50^\circ\text{C} + 58.44^\circ\text{C} = 108.44^\circ\text{C}$$
(5)

7.3.4 Protection Features

The TPS798xx-Q1 incorporates several protection features that make it ideal for use in battery-powered circuits. In addition to the normal protection features associated with monolithic regulators, such as current limiting and thermal limiting, the device is protected against reverse-input voltages, and reverse currents from output to input.

Current limit protection and thermal-overload protection are intended to protect the device against current overload conditions at the output of the device. The junction temperature should not exceed 125°C.

The input of the device withstands reverse voltages of –60 V. Current flow into the device is limited to less than 6 mA (typically, less than 100 μA), and no negative voltage appears at the output. The device protects both itself and the load. This architecture also provides protection against batteries that may be plugged in backwards.

Feature Description (continued)

The FB pin of the adjustable device can be pulled above or below ground by as much as 7 V without damaging the device. If the input is left open or grounded, the FB pin behaves as an open circuit when pulled below ground, or as a large resistor (typically, 100 k Ω) in series with a diode when pulled above ground. If the input is powered by a voltage source, pulling the FB pin below the reference voltage increases the output voltage. This configuration causes the output to go to a unregulated high voltage. Pulling the FB pin above the reference voltage turns off all output current.

In situations where the FB pin is connected to a resistor divider that would pull the FB pin above its 7-V clamp voltage if the output is pulled high, the FB pin input current must be limited to less than 5 mA. For example, a resistor divider provides a regulated 1.5-V output from the 1.275-V reference when the output is forced to 28 V. The top resistor of the resistor divider must be chosen to limit the current into the FB pin to less than 5 mA when the FB pin is at 7 V. The 21-V difference between the OUT and FB pins divided by the 5-mA maximum current into the FB pin yields a minimum top resistor value of 5.8 k Ω .

In circuits where a backup battery is required, several different input/output conditions can occur. The output voltage may be held up while the input is either pulled to ground, pulled to some intermediate voltage, or is left open. The rise in reverse output current above 7 V occurs from the breakdown of the 7-V clamp on the FB pin. With a resistor divider on the regulator output, this current is reduced, depending on the size of the resistor divider.

When the IN pin of the TPS798xx-Q1 is forced below the OUT pin, or the OUT pin is pulled above the IN pin, input current typically drops to less than 0.6 mA. This scenario can occur if the input of the TPS798xx-Q1 is connected to a discharged (low voltage) battery and the output is held up by either a backup battery or a second regulator circuit. The state of the EN pin has no effect on the reverse output current when the output is pulled above the input.

7.4 Device Functional Modes

7.4.1 Low-Voltage Tracking

At low input voltages, the regulator drops out of regulation and the output voltage tracks input minus a voltage based on the load current and switch resistance. This allows for a smaller input capacitor and can possibly eliminate the need of using a boost convertor during cold-crank conditions.

8 Application and Implementation

NOTE

Information in the following applications sections is not part of the TI component specification, and TI does not warrant its accuracy or completeness. TI's customers are responsible for determining suitability of components for their purposes. Customers should validate and test their design implementation to confirm system functionality.

8.1 Application Information

Figure 19 shows typical application circuits for the TPS79801-Q1 device. Based on the end-application, different values of external components can be used.

8.2 Typical Application

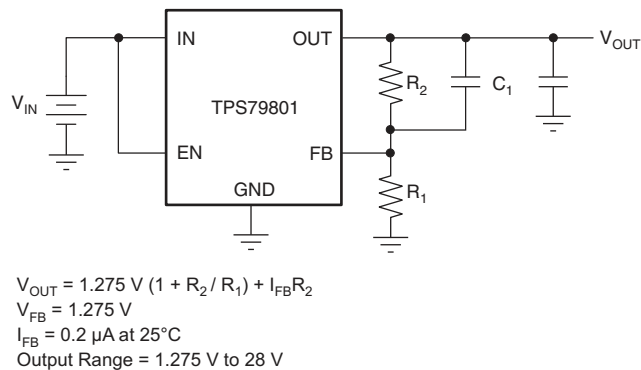

Figure 19. Adjustable Operation Example

8.2.1 Design Requirements

Table 1 lists the design parameters for this example.

Table 1. Design Parameters

DESIGN PARAMETER	EXAMPLE VALUE
Input voltage range	3 V to 50 V
Output voltage	5 V
Output current rating	50 mA
Output capacitor range	1 μF to 100 μF

8.2.2 Detailed Design Procedure

To begin the design process, determine the following:

1. Input voltage range
2. Output voltage
3. Output current rating
4. Output capacitor

8.2.3 Application Curves

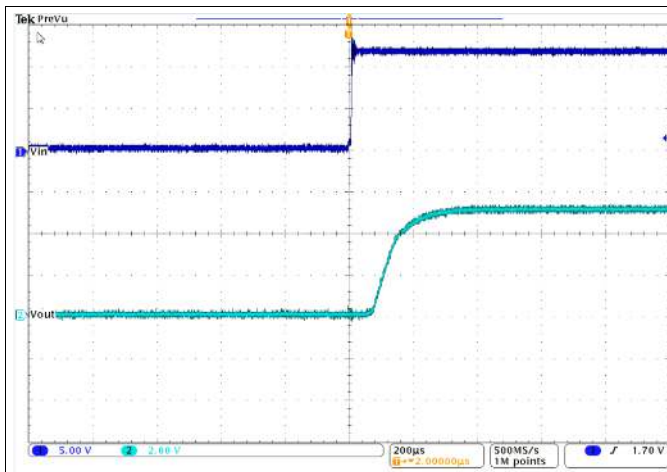

Figure 20. CH1: Vin, CH2: Vout Power-Up Waveform (Load = 50 mA)

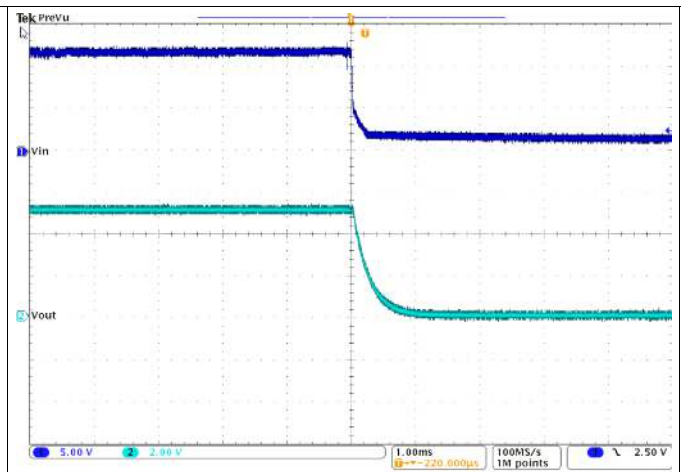

Figure 21. CH1: Vin, CH2: Vout Power-Down Waveform (Load = 50 mA)

9 Power Supply Recommendations

9.1 Thermal Considerations

The power handling capability of the device is limited by the maximum rated junction temperature (125°C). The power dissipated by the device consists of two components:

- Output current multiplied by the input/output voltage differential: $I_{OUT} \times (V_{IN} - V_{OUT})$
- GND pin current multiplied by the input voltage: $I_{GND} \times V_{IN}$

The GND pin current can be found by examining the GND pin current curves in the *Typical Characteristics*. Power dissipation is equal to the sum of the two components listed previously.

The TPS798xx-Q1 series regulators have internal thermal limiting designed to protect the device during overload conditions. Do not exceed the maximum junction temperature rating of 125°C. It is important to carefully consider all sources of thermal resistance from junction to ambient. Additional heat sources mounted nearby must also be considered.

For surface-mount devices, heat sinking is accomplished by using the heat-spreading capabilities of the printed-circuit-board (PCB) and its copper traces. Copper board stiffeners and plated through-holes can also be used to spread the heat generated by power devices.

10 Layout

10.1 Layout Guidelines

- Do not place any of the capacitors on the opposite side of the PCB from where the regulator is installed. TI strongly discourages using vias and long traces because of the negative impact on system performance. Vias and long traces can also cause instability.
- Equivalent series inductance (ESL) and ESR must be minimized to maximize performance and ensure stability. Every capacitor must be placed as close to the device as possible and on the same side of the PCB as the regulator.

10.2 Layout Example

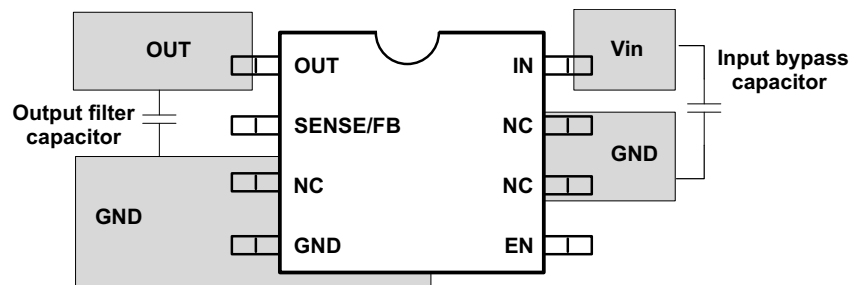

10.3 Thermal Considerations

The amount of heat that an LDO linear regulator generates is directly proportional to the amount of power it dissipates during operation. All integrated circuits have a maximum allowable junction temperature ($T_J \text{ max}$) above which normal operation is not assured. The operating environment must be designed so that the operating junction temperature (T_J) does not exceed the maximum junction temperature ($T_J \text{ max}$). The two primary environmental variables that can be used to improve thermal performance are air flow and external heatsinks. The purpose of this section is to help the designer to determine the proper operating environment for a linear regulator that operates at a specific power level.

Thermal Considerations (continued)

In general, the maximum expected power ($P_D \text{ max}$) consumed by a linear regulator is computed as shown in Equation 6:

$$P_{D \text{ max}} = (V_{IN(\text{avg})} - V_{OUT(\text{avg})}) \times I_{OUT(\text{avg})} + V_{I(\text{avg})} \times I_Q$$

where

- $V_{IN(\text{avg})}$ is the average input voltage.
- $V_{OUT(\text{avg})}$ is the average output voltage.
- $I_{OUT(\text{avg})}$ is the average output current.
- I_Q is the quiescent current.

(6)

For most TI LDO regulators, the quiescent current is insignificant compared to the average output current; therefore, the term $V_{IN(\text{avg})} \times I_Q$ can be ignored. The operating junction temperature is computed by adding the ambient temperature (T_A) and the increase in temperature as a result of the regulator power dissipation. The temperature rise is computed by multiplying the maximum expected power dissipation by the sum of the thermal resistances between the junction and the case ($R_{\theta JC}$), the case to heatsink ($R_{\theta CS}$), and the heatsink to ambient ($R_{\theta SA}$). Thermal resistances are measurements of how effectively an object dissipates heat. Typically, the larger the device, the more surface area available for power dissipation and the lower the device thermal resistance.

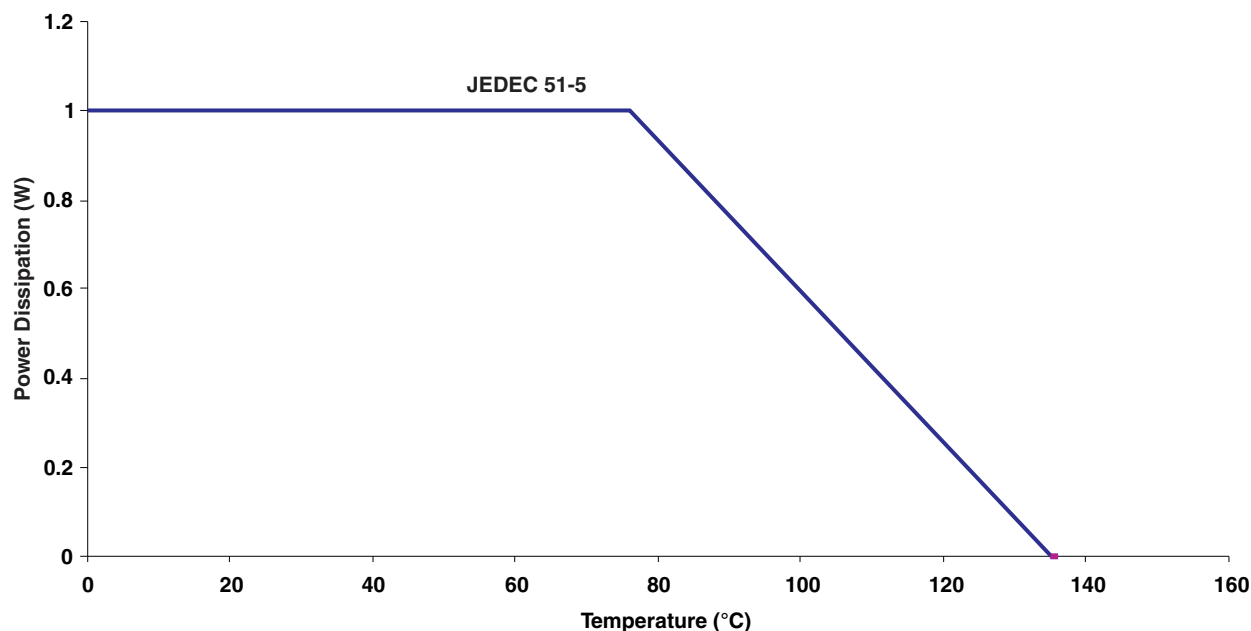

Figure 22. Power Dissipation vs Temperature

11 Device and Documentation Support

11.1 Related Links

The following table lists quick access links. Categories include technical documents, support and community resources, tools and software, and quick access to sample or buy.

Table 2. Related Links

PARTS	PRODUCT FOLDER	SAMPLE & BUY	TECHNICAL DOCUMENTS	TOOLS & SOFTWARE	SUPPORT & COMMUNITY
TPS79801-Q1	Click here	Click here	Click here	Click here	Click here
TPS79850-Q1	Click here	Click here	Click here	Click here	Click here

11.2 Community Resources

The following links connect to TI community resources. Linked contents are provided "AS IS" by the respective contributors. They do not constitute TI specifications and do not necessarily reflect TI's views; see TI's [Terms of Use](#).

TI E2E™ Online Community *TI's Engineer-to-Engineer (E2E) Community*. Created to foster collaboration among engineers. At e2e.ti.com, you can ask questions, share knowledge, explore ideas and help solve problems with fellow engineers.

Design Support *TI's Design Support* Quickly find helpful E2E forums along with design support tools and contact information for technical support.

11.3 Trademarks

PowerPAD, E2E are trademarks of Texas Instruments.
All other trademarks are the property of their respective owners.

11.4 Electrostatic Discharge Caution



These devices have limited built-in ESD protection. The leads should be shorted together or the device placed in conductive foam during storage or handling to prevent electrostatic damage to the MOS gates.

11.5 Glossary

SLYZ022 — *TI Glossary*.

This glossary lists and explains terms, acronyms, and definitions.

12 Mechanical, Packaging, and Orderable Information

The following pages include mechanical, packaging, and orderable information. This information is the most current data available for the designated devices. This data is subject to change without notice and revision of this document. For browser-based versions of this data sheet, refer to the left-hand navigation.

PACKAGING INFORMATION

Orderable Device	Status (1)	Package Type	Package Drawing	Pins	Package Qty	Eco Plan (2)	Lead finish/ Ball material (6)	MSL Peak Temp (3)	Op Temp (°C)	Device Marking (4/5)	Samples
TPS79801QDGNRQ1	ACTIVE	HVSSOP	DGN	8	2500	RoHS & Green	NIPDAUAG	Level-2-260C-1 YEAR	-40 to 125	PMRQ	Samples
TPS79850QDGNRQ1	ACTIVE	HVSSOP	DGN	8	2500	RoHS & Green	NIPDAUAG	Level-2-260C-1 YEAR	-40 to 125	OOLQ	Samples

(1) The marketing status values are defined as follows:

ACTIVE: Product device recommended for new designs.

LIFEBUY: TI has announced that the device will be discontinued, and a lifetime-buy period is in effect.

NRND: Not recommended for new designs. Device is in production to support existing customers, but TI does not recommend using this part in a new design.

PREVIEW: Device has been announced but is not in production. Samples may or may not be available.

OBSOLETE: TI has discontinued the production of the device.

(2) **RoHS:** TI defines "RoHS" to mean semiconductor products that are compliant with the current EU RoHS requirements for all 10 RoHS substances, including the requirement that RoHS substance do not exceed 0.1% by weight in homogeneous materials. Where designed to be soldered at high temperatures, "RoHS" products are suitable for use in specified lead-free processes. TI may reference these types of products as "Pb-Free".

RoHS Exempt: TI defines "RoHS Exempt" to mean products that contain lead but are compliant with EU RoHS pursuant to a specific EU RoHS exemption.

Green: TI defines "Green" to mean the content of Chlorine (Cl) and Bromine (Br) based flame retardants meet JS709B low halogen requirements of <=1000ppm threshold. Antimony trioxide based flame retardants must also meet the <=1000ppm threshold requirement.

(3) MSL, Peak Temp. - The Moisture Sensitivity Level rating according to the JEDEC industry standard classifications, and peak solder temperature.

(4) There may be additional marking, which relates to the logo, the lot trace code information, or the environmental category on the device.

(5) Multiple Device Markings will be inside parentheses. Only one Device Marking contained in parentheses and separated by a "~" will appear on a device. If a line is indented then it is a continuation of the previous line and the two combined represent the entire Device Marking for that device.

(6) Lead finish/Ball material - Orderable Devices may have multiple material finish options. Finish options are separated by a vertical ruled line. Lead finish/Ball material values may wrap to two lines if the finish value exceeds the maximum column width.

Important Information and Disclaimer:The information provided on this page represents TI's knowledge and belief as of the date that it is provided. TI bases its knowledge and belief on information provided by third parties, and makes no representation or warranty as to the accuracy of such information. Efforts are underway to better integrate information from third parties. TI has taken and continues to take reasonable steps to provide representative and accurate information but may not have conducted destructive testing or chemical analysis on incoming materials and chemicals. TI and TI suppliers consider certain information to be proprietary, and thus CAS numbers and other limited information may not be available for release.

In no event shall TI's liability arising out of such information exceed the total purchase price of the TI part(s) at issue in this document sold by TI to Customer on an annual basis.

TAPE AND REEL INFORMATION

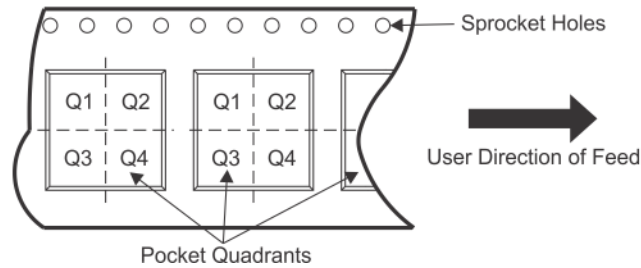
QUADRANT ASSIGNMENTS FOR PIN 1 ORIENTATION IN TAPE

*All dimensions are nominal

Device	Package Type	Package Drawing	Pins	SPQ	Reel Diameter (mm)	Reel Width W1 (mm)	A0 (mm)	B0 (mm)	K0 (mm)	P1 (mm)	W (mm)	Pin1 Quadrant
TPS79801QDGNRQ1	HVSSOP	DGN	8	2500	330.0	12.4	5.3	3.3	1.3	8.0	12.0	Q1
TPS79850QDGNRQ1	HVSSOP	DGN	8	2500	330.0	12.4	5.3	3.3	1.3	8.0	12.0	Q1

TAPE AND REEL BOX DIMENSIONS

*All dimensions are nominal

Device	Package Type	Package Drawing	Pins	SPQ	Length (mm)	Width (mm)	Height (mm)
TPS79801QDGNRQ1	HVSSOP	DGN	8	2500	367.0	367.0	38.0
TPS79850QDGNRQ1	HVSSOP	DGN	8	2500	367.0	367.0	38.0

GENERIC PACKAGE VIEW

DGN 8

PowerPAD VSSOP - 1.1 mm max height

3 x 3, 0.65 mm pitch

SMALL OUTLINE PACKAGE

This image is a representation of the package family, actual package may vary.
Refer to the product data sheet for package details.

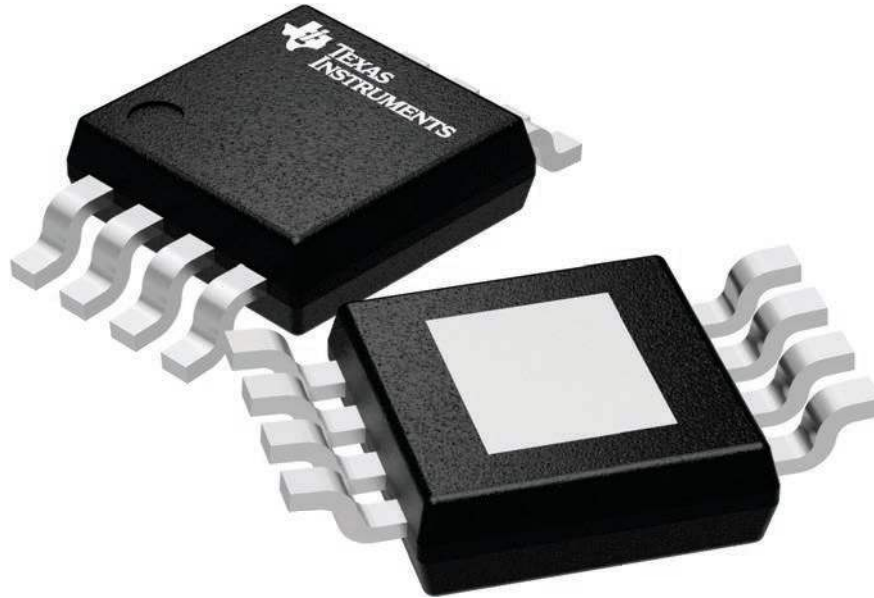

4225482/A

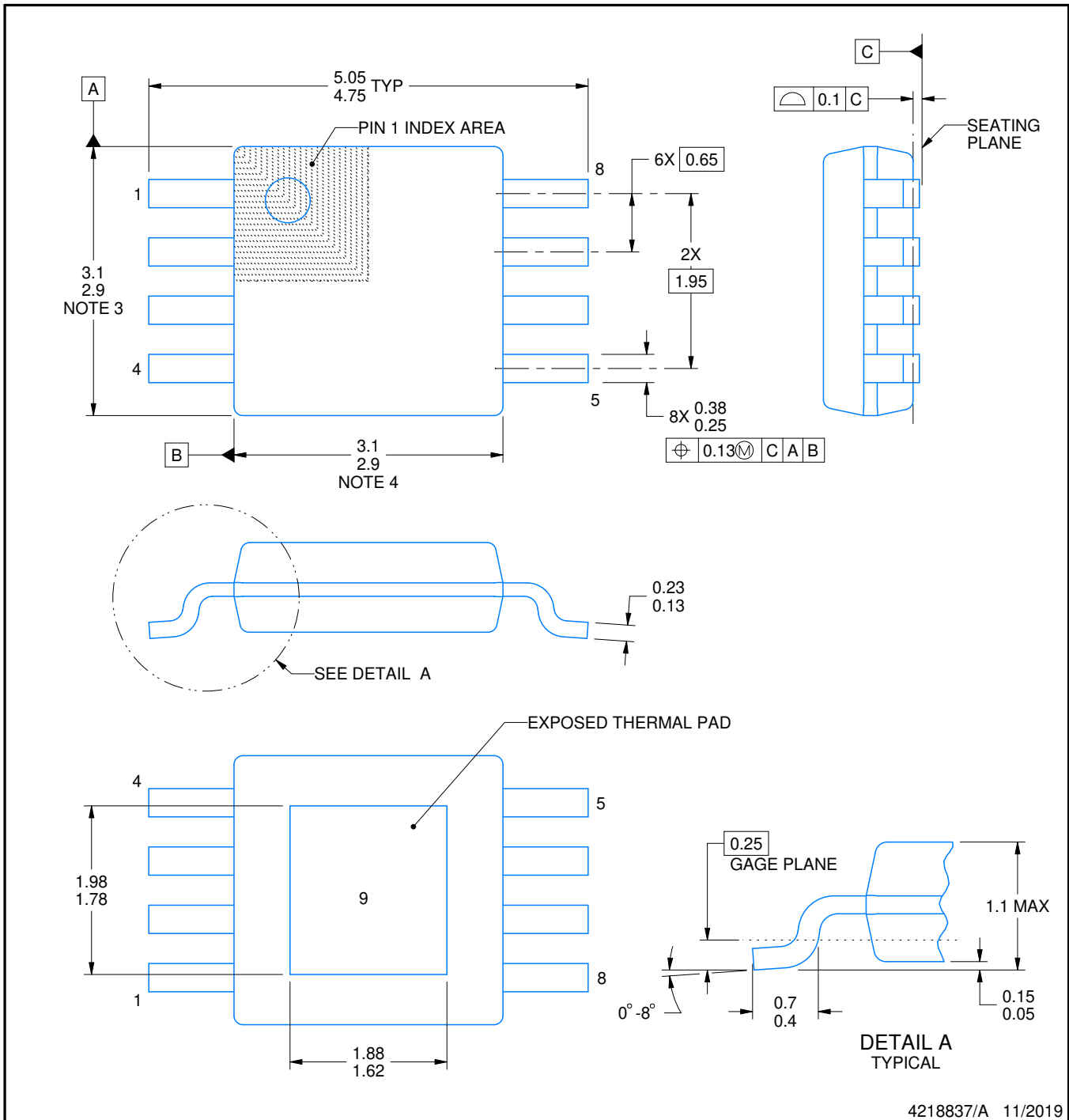
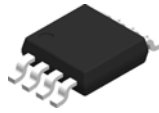

4218837/A 11/2019

PowerPAD is a trademark of Texas Instruments.

NOTES:

1. All linear dimensions are in millimeters. Any dimensions in parenthesis are for reference only. Dimensioning and tolerancing per ASME Y14.5M.
2. This drawing is subject to change without notice.
3. This dimension does not include mold flash, protrusions, or gate burrs. Mold flash, protrusions, or gate burrs shall not exceed 0.15 mm per side.
4. This dimension does not include interlead flash. Interlead flash shall not exceed 0.25 mm per side.
5. Reference JEDEC registration MO-187.

EXAMPLE BOARD LAYOUT

DGN0008B

PowerPAD™ VSSOP - 1.1 mm max height

SMALL OUTLINE PACKAGE

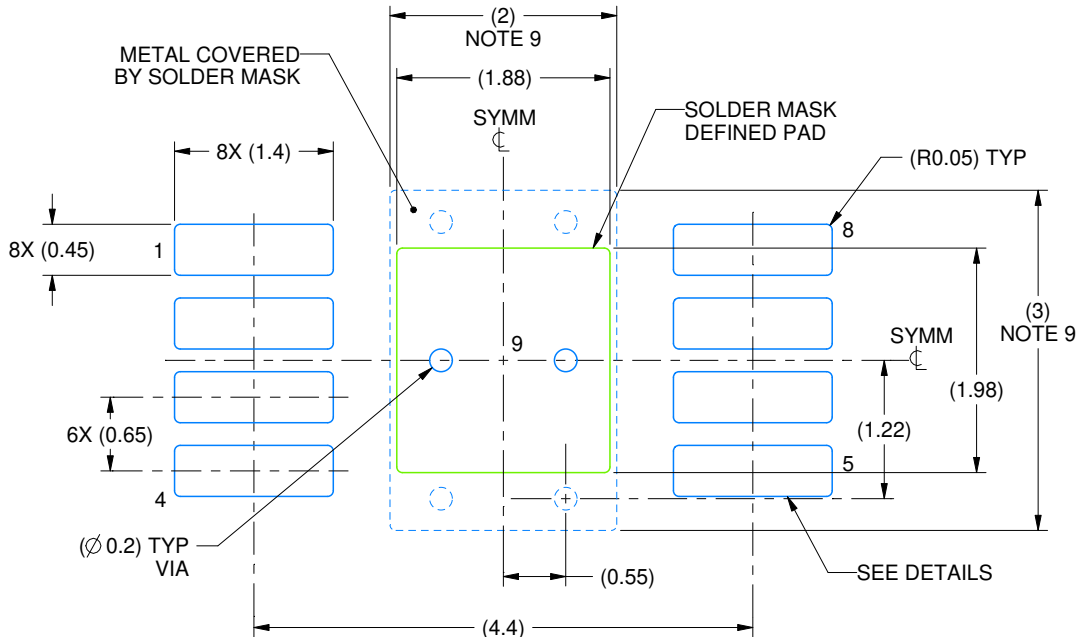

LAND PATTERN EXAMPLE
EXPOSED METAL SHOWN
SCALE: 15X

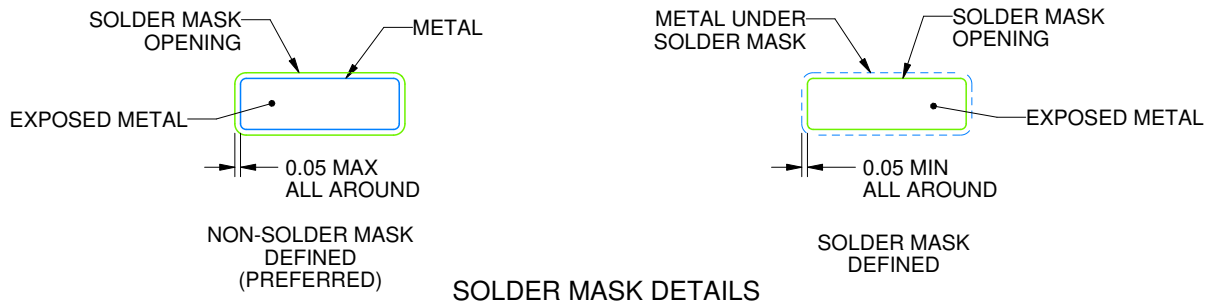

4218837/A 11/2019

NOTES: (continued)

- 6. Publication IPC-7351 may have alternate designs.
- 7. Solder mask tolerances between and around signal pads can vary based on board fabrication site.
- 8. Vias are optional depending on application, refer to device data sheet. If any vias are implemented, refer to their locations shown on this view. It is recommended that vias under paste be filled, plugged or tented.
- 9. Size of metal pad may vary due to creepage requirement.

EXAMPLE STENCIL DESIGN

DGN0008B

PowerPAD™ VSSOP - 1.1 mm max height

SMALL OUTLINE PACKAGE

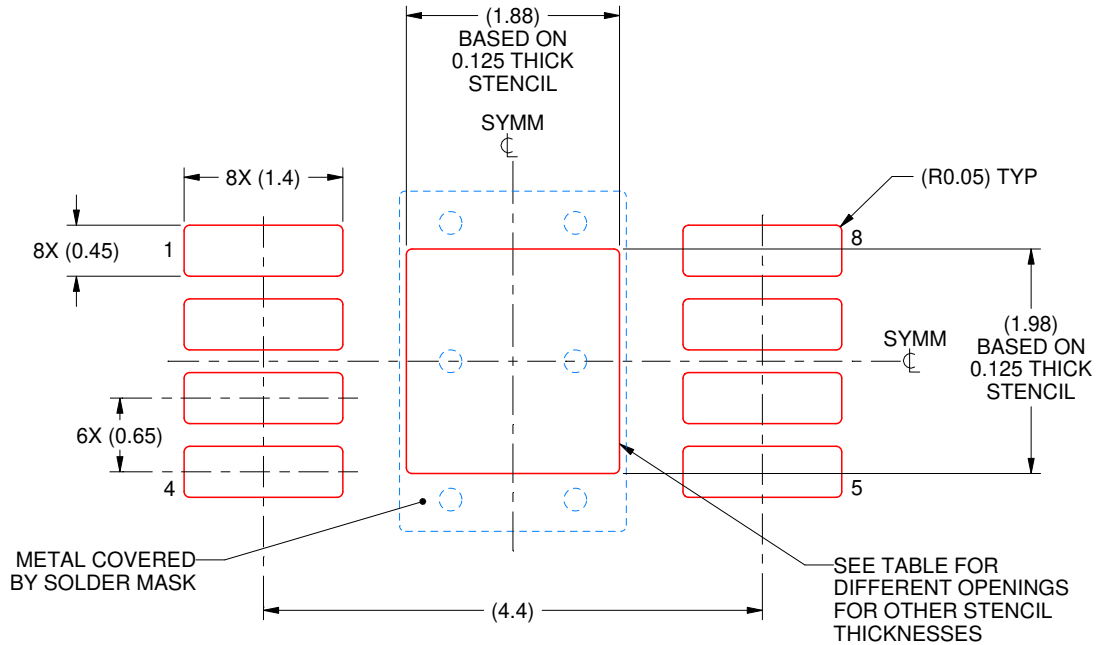

SOLDER PASTE EXAMPLE
EXPOSED PAD 9:
100% PRINTED SOLDER COVERAGE BY AREA
SCALE: 15X

STENCIL THICKNESS	SOLDER STENCIL OPENING
0.1	2.10 X 2.21
0.125	1.88 X 1.98 (SHOWN)
0.15	1.72 X 1.81
0.175	1.59 X 1.67

4218837/A 11/2019

NOTES: (continued)

10. Laser cutting apertures with trapezoidal walls and rounded corners may offer better paste release. IPC-7525 may have alternate design recommendations.
11. Board assembly site may have different recommendations for stencil design.

IMPORTANT NOTICE AND DISCLAIMER

TI PROVIDES TECHNICAL AND RELIABILITY DATA (INCLUDING DATASHEETS), DESIGN RESOURCES (INCLUDING REFERENCE DESIGNS), APPLICATION OR OTHER DESIGN ADVICE, WEB TOOLS, SAFETY INFORMATION, AND OTHER RESOURCES "AS IS" AND WITH ALL FAULTS, AND DISCLAIMS ALL WARRANTIES, EXPRESS AND IMPLIED, INCLUDING WITHOUT LIMITATION ANY IMPLIED WARRANTIES OF MERCHANTABILITY, FITNESS FOR A PARTICULAR PURPOSE OR NON-INFRINGEMENT OF THIRD PARTY INTELLECTUAL PROPERTY RIGHTS.

These resources are intended for skilled developers designing with TI products. You are solely responsible for (1) selecting the appropriate TI products for your application, (2) designing, validating and testing your application, and (3) ensuring your application meets applicable standards, and any other safety, security, or other requirements. These resources are subject to change without notice. TI grants you permission to use these resources only for development of an application that uses the TI products described in the resource. Other reproduction and display of these resources is prohibited. No license is granted to any other TI intellectual property right or to any third party intellectual property right. TI disclaims responsibility for, and you will fully indemnify TI and its representatives against, any claims, damages, costs, losses, and liabilities arising out of your use of these resources.

TI's products are provided subject to TI's Terms of Sale (<https://www.ti.com/legal/termsofsale.html>) or other applicable terms available either on [ti.com](https://www.ti.com) or provided in conjunction with such TI products. TI's provision of these resources does not expand or otherwise alter TI's applicable warranties or warranty disclaimers for TI products.

Mailing Address: Texas Instruments, Post Office Box 655303, Dallas, Texas 75265
Copyright © 2021, Texas Instruments Incorporated