

RECOMMENDED PCB LAYOUT
AS VIEWED FROM COMPONENT SIDE

Specification 规格:

Electrical 电气规格:

- Voltage Rating 电压额定值: 125 V AC (RMS)
- Current Rating 电流额定值: 1.5 Amp
- Contact Resistance 接触电阻值: 35mΩ Max.
- Insulation Resistance 绝缘电阻值: 1000MΩ Min. @ 500 VDC
- Dielectric Strength 电介质强度: 1000 VAC RMS 60Hz, 1 Min.

Material 物料规格:

- Housing Material 塑胶外壳: High Temp Nylon UL94V-0 or Glass Filled Polyester, Black
- Contact Material 端子材料: Phosphor Bronze 0.35mm Thickness
- Plating 电镀规格: Gold Plating over Nickel
- Operating Life 使用寿命: 750 Cycles Min.
- PCB Retention Force After Solder 焊接后保持力: 10 LBS Min.

Environmental 环境的:

- Storage Temperature 储存温度: -40°C to +85°C
- Operation Temperature 使用温度: -40°C to +85°C

Ordering Grid

MJ3106-88-X-X

No. of Positions/ Positions Loaded
88 = 8/8

Contact Plating
2 = 6μ" Gold (Standard)
4 = 30μ" Gold

Insulator Material
N = High Temp Nylon (Standard)
P = Glass Filled Polyester

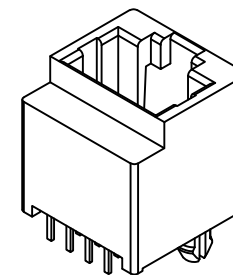

| | | | | | | | | |
|-------------------|----------|--|--------------|--|--|----------------|--|-------------|
| Part Number | | Product Description | | | This drawing is confidential and copyright of Global Connector Technology, Ltd (GCT). This drawing must not be copied or disclosed without written consent. E & OE | www.gct.co | | |
| MJ3106 8 Position | | Modular Jack Connector | | | | | | |
| Drawing Date | | 8 Position, Category 3, Vertical, Through Hole | | | | | | |
| 21st April 2010 | | | | | | | | |
| By | CC | Tolerances (Except as Noted) | | | | | | Units: |
| Detail | Obsolete | Length | Angle | | | | | Metric (mm) |
| Revision | X | X.X ± 0.20 | ± 5° | | | | | |
| Date | 25/07/22 | X.XX ± 0.15 | X.XXX ± 0.10 | | | | | |

1. Packing Material 包材 - Tray 1 PC

Quantity 數量 - 1*100=100 PCS

Tray: Body and Cover 真空盒上下蓋各 - 1PC Each
Label 标签 - 1 PC

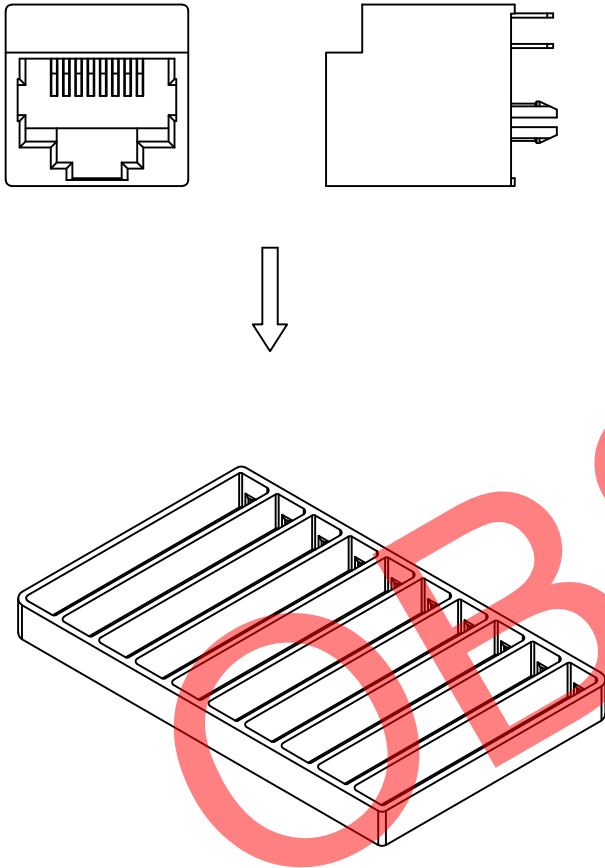



2. Packing Material 包材 - Carton - 380*315*290 - 1 PC

Quantity 數量 - 100*28=2800 PCS

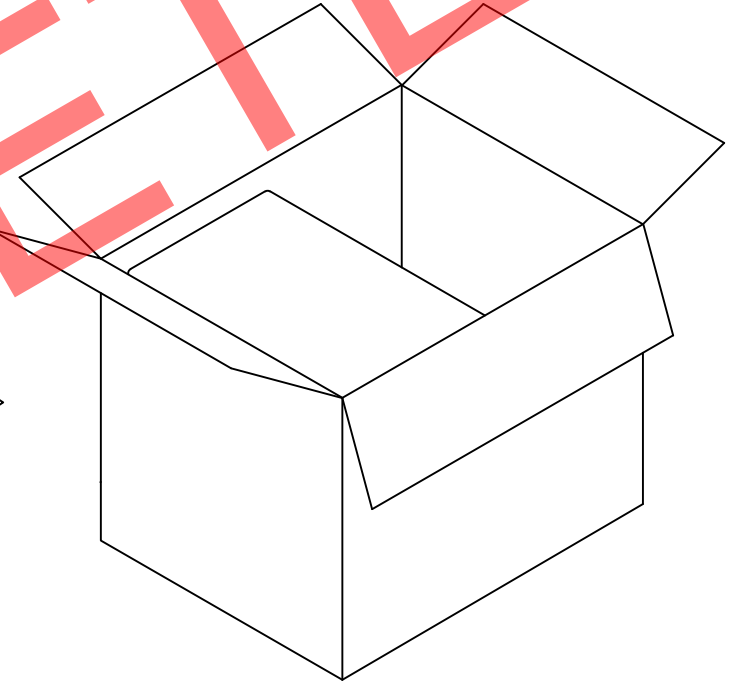
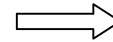
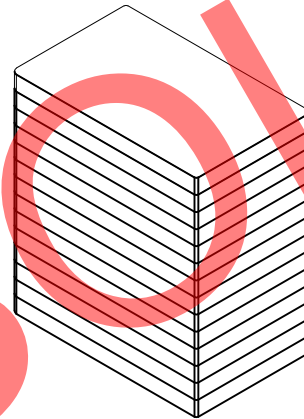
| Part Number 零部件料号 | Net Weight 淨重 | Gross Weight 毛重 | Q'TY 數量 |
|----------------------|------------------|--------------------|------------|
| MJ3105-88-X-X | 8.98Kg | 10.25Kg | 2800 |



| | | | | |
|----------------------------------|--|--|--|---|
| Part Number MJ3106 8 Position | | Product Description Modular Jack Connector 8 Position, Category 3, Vertical, Through Hole | |  www.gct.co |
| Drawing Date 21st April 2010 | | | | |
| By CC | Tolerances (Except as Noted) Length | Units: Metric (mm) |  This drawing is confidential and copyright of Global Connector Technology, Ltd (GCT). This drawing must not be copied or disclosed without written consent. E & OE | |
| Detail Obsolete | Angle |  3rd Angle Projection | | |
| Revision X | Date 25/07/22 | | | Not to Scale Drawn By PKN Sheet No. 2/2 |