

Evaluating the **ADT7320/ADT7420** Temperature Sensors

FEATURES

Supports the **ADT7320** and **ADT7420** temperature sensors

Powered from USB port—no additional power supply required

PC software for control of temperature sensors

Supported operating systems: Windows 2000 and higher

Additional external evaluation board for remote temperature measurements (ADT7x20MBZ)

Additional external flex boards for faster thermal response

EVALUATION KIT CONTENTS

Fully fitted printed circuit board (PCB) with USB interface

Additional external PCB

Evaluation software CD

USB cable

Documentation

Wiring guide

OPTIONAL EQUIPMENT

ADT7320FBZ flex board

ADT7420FBZ flex board

GENERAL DESCRIPTION

This user guide describes the EVAL-ADT7x20EBZ, ADT7320FBZ, and ADT7420FBZ evaluation board hardware and software and includes detailed schematics and PCB layout artwork. The ADT7x20 (EVAL-ADT7x20EBZ) evaluation board is a compact, easy-to-use platform for evaluating all features of the **ADT7320** and **ADT7420** temperature sensors.

The ADT7x20FBZ flex boards are optional extras to the evaluation kit, which can be used as an extension to the ADT7x20 evaluation board or as standalone devices for interfacing with a microcontroller or FPGA.

The evaluation kit allows the user to evaluate the performance of the **ADT7320** and **ADT7420** temperature sensors using a PC. The kit consists of two boards; a main board connected to the PC through the USB port and an external board. The external board and flex board are attached to the main board using wires that can withstand high temperatures, and can be used for remote temperature measurements in oil baths or ovens where the temperature exceeds the specifications of the USB cable.

The evaluation software allows the user to select the main board or the external board, as well as the desired temperature sensor device.

When using the ADT7x20 evaluation board, in addition to this user guide, the user should also consult the **ADT7320** and **ADT7420** data sheets (available at the Analog Devices, Inc., website, www.analog.com).



Figure 1. ADT7x20 Evaluation Board—Main Board

TABLE OF CONTENTS

Features	1	Device Selection	4
Evaluation Kit Contents.....	1	Board Selection.....	4
Optional Equipment.....	1	Device Evaluation Software	5
General Description	1	Wiring Guidelines	8
Revision History	2	Evaluation Board Schematics and Artwork.....	9
External Board Photographs.....	3	Ordering Information.....	15
Evaluation Board Software.....	4	Bill of Materials.....	15
Software Installation	4	Related Links.....	16
Using the ADT7x20 Evaluation Software	4		

REVISION HISTORY

10/14—Rev. A to Rev. B

Changes to Table 2.....	8
Changed Figure 25, Figure 26, Figure 27 Captions.....	14

8/13—Rev. 0 to Rev. A

Added Optional ADT7320FBZ and ADT7420FBZ Flex Boards	Universal
---	-----------

12/12—Revision 0: Initial Version

EXTERNAL BOARD PHOTOGRAPHS

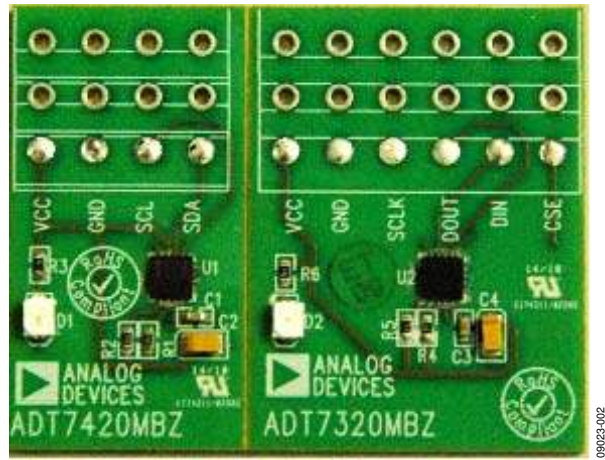

Figure 2. ADT7x20 Evaluation Board—External Board



Figure 3. ADT7320FBZ Evaluation Board—External Board

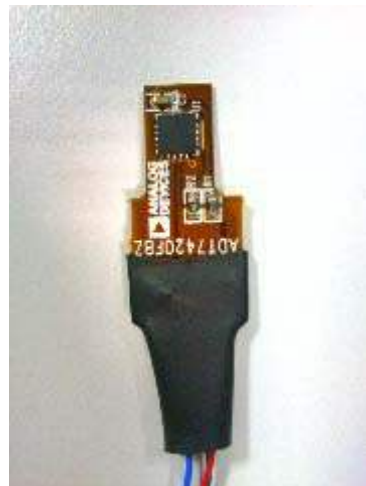

Figure 4. ADT7420FBZ Evaluation Board—External Board

EVALUATION BOARD SOFTWARE

SOFTWARE INSTALLATION

The ADT7x20 evaluation kit includes the evaluation software on a CD-ROM. The software is compatible with Windows® 2000/XP, Vista, and Windows 7. The evaluation software must be installed before connecting the evaluation board to the USB port of the PC to ensure that Windows recognizes it and to ensure that the driver is installed correctly. To install the software, run the **ADT7x20 Evaluation Software Install.exe** file from the CD-ROM.

After the installation has completed, connect the ADT7x20 evaluation board to the PC USB port using the cable supplied.

When the evaluation board is detected by the operating system, proceed through any dialog boxes that appear to finalize the installation.

USING THE ADT7x20 EVALUATION SOFTWARE

During installation, a shortcut to the evaluation software is installed in the **Start** menu. From the **Start** menu, select **All Programs**, then **Analog Devices**, and click **ADT7x20 Evaluation Software**. You can launch the software using either this shortcut or by running the **ADT7x20 Evaluation Software.exe** file from the installation directory.

DEVICE SELECTION

When the evaluation software is launched, a window appears prompting you to select the desired device, as shown in Figure 5.

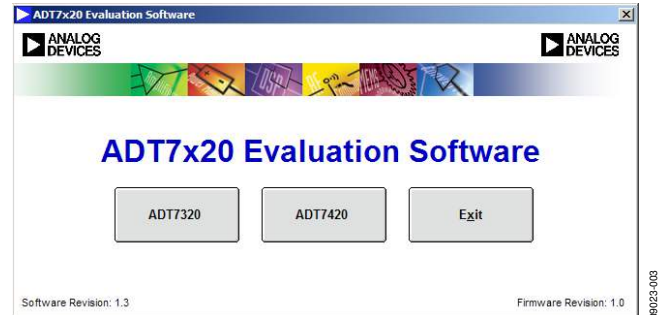

Figure 5. Device Selection Window

The ADT7320 uses the SPI interface whereas the ADT7420 uses the I²C. Other than the control interface, the two devices are identical in performance.

BOARD SELECTION

The device selected at the previous step in the Device Selection section can be located either on the main board or on the external board.

After the desired device is selected, a window appears prompting you to select the location of the device (see Figure 6).

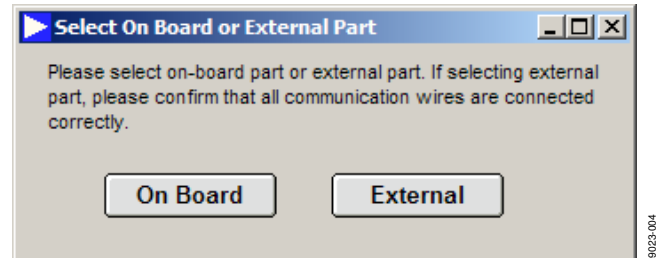

Figure 6. On-Board/External Device Selection Window

DEVICE EVALUATION SOFTWARE

After you complete the device and board selections, the evaluation software loads, allowing full control over the selected device. The software layout is the same for both the [ADT7320](#) and [ADT7420](#). There are three tabs in the evaluation software:

- Configuration Register
- Temperature Monitor
- ADT7x20 Registers

The evaluation software also has **Easy Setup** and **Close** options.

Configuration Register

This tab allows you full control over the configuration register of the selected device, as shown in Figure 7. At startup, the evaluation software initializes the configuration register to the default value of 0x90 (hexadecimal). For more details on how to set the configuration register, consult the device data sheet.

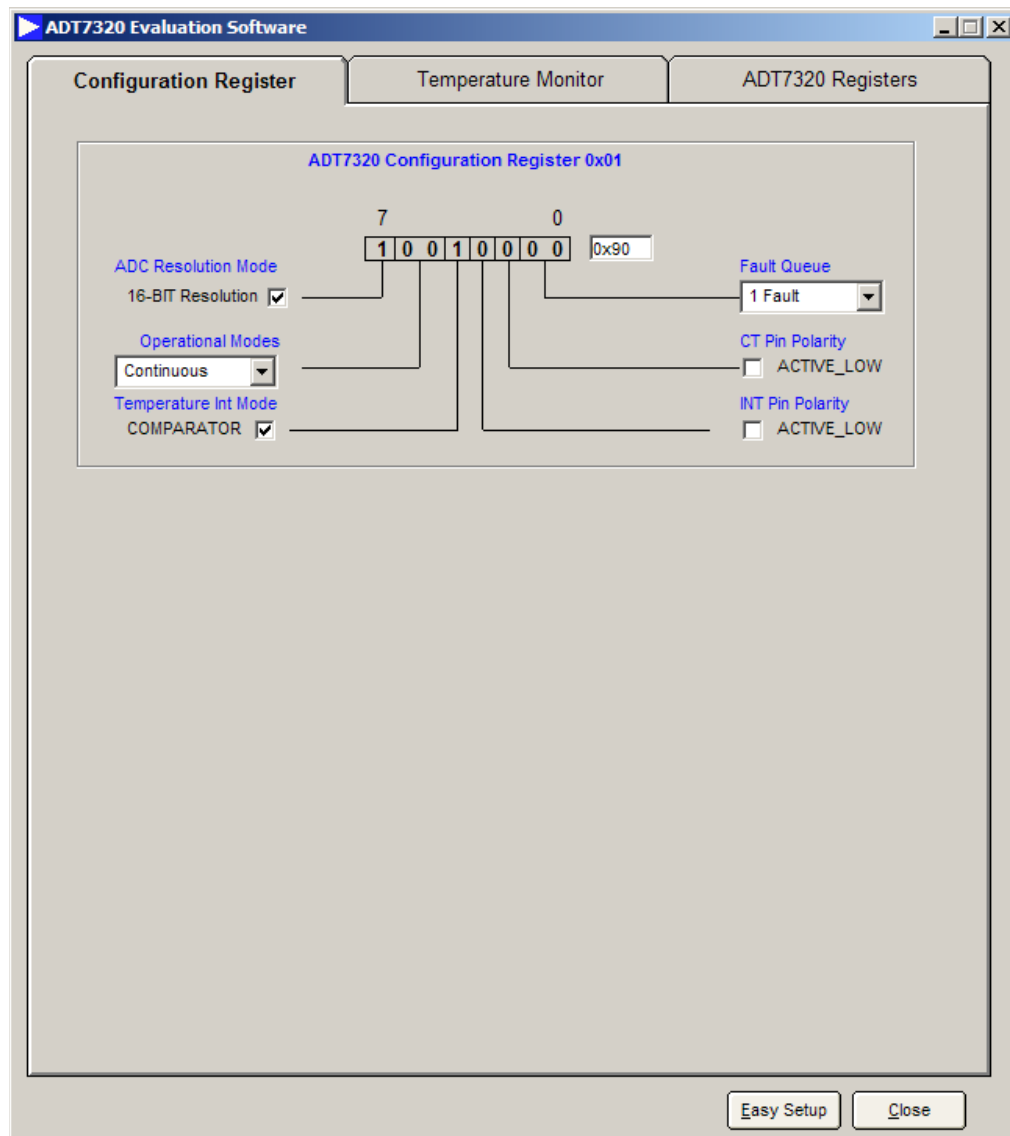

Figure 7. Configuration Register Tab

Temperature Monitor

This tab displays the temperature reading from the selected device as well as the status of the alarms. This tab includes five control options (see Figure 8):

- Temperature Threshold
- Temperature Value
- Set Temperature Limits
- Log Data
- Temperature Values

Temperature Threshold

If the temperature goes above or below the high and low limits defined in the **Set Temperature Limits** section or above the critical threshold, the **Temperature High Limit Threshold**, **Temperature Low Limit Threshold**, and **Temperature Critical Threshold** indicators appear green.

Temperature Value

This displays the actual ADC temperature in twos complement and degrees Celsius respectively.

Set Temperature Limits

This section allows you to update the high, low, critical, and hysteresis limits. These ADC values are loaded into the device. Because the conversion format is twos complement, any value over 4095 is a negative number. To change the value, you can use the arrow keys or type a number in the box to update the limits. The graph labeled **Temperature Conversion Measurement** displays the variation in time of the high and low temperature limits as well as the current temperature in twos complement format. At startup, the evaluation software initializes the temperature limits registers (T_{HIGH} , T_{LOW} , T_{CRIT} , and T_{HYST}) to the default values shown in Figure 6.

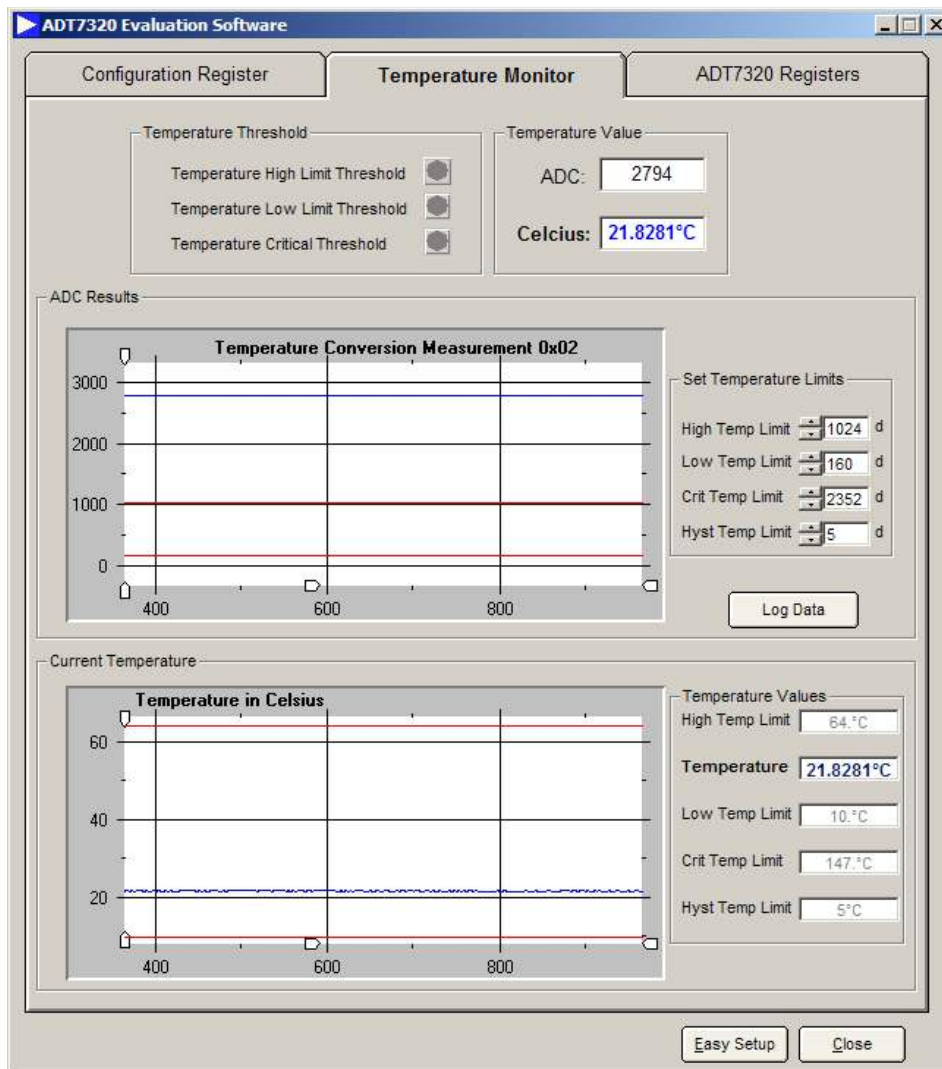

Figure 8. Temperature Monitor

Log Data

The software can save the acquired data into an Excel or text file by clicking the **Log Data** button, which opens the dialog box shown in Figure 7 From this window, you can choose to log the ADC, the Celsius value, or both, as well as set the logging interval (see Figure 7).

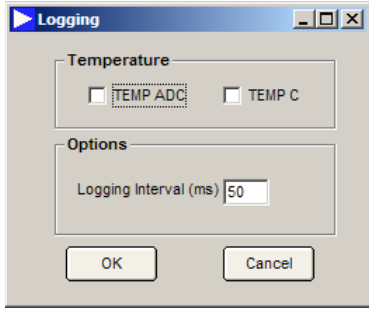

Figure 9. Data Logging

Temperature Values

This section gives you an update of all the temperature limits and the temperature reading of the part. These values are a replica of the ADC values in the **Set Temperature Limits** section, converted into degrees Celsius. The graph labeled **Temperature in Celsius** displays the variation in time of the high and low temperature limits as well as the current temperature in degrees Celsius.

Register Map

This section displays all the register values for the part. You can read or write to any register by using the **Read** and **Write** buttons (see Figure 8).

Easy Setup

The **Easy Setup** button restores all registers with default values.

Close

This button closes the current window and returns to the selection window (see Figure 3).

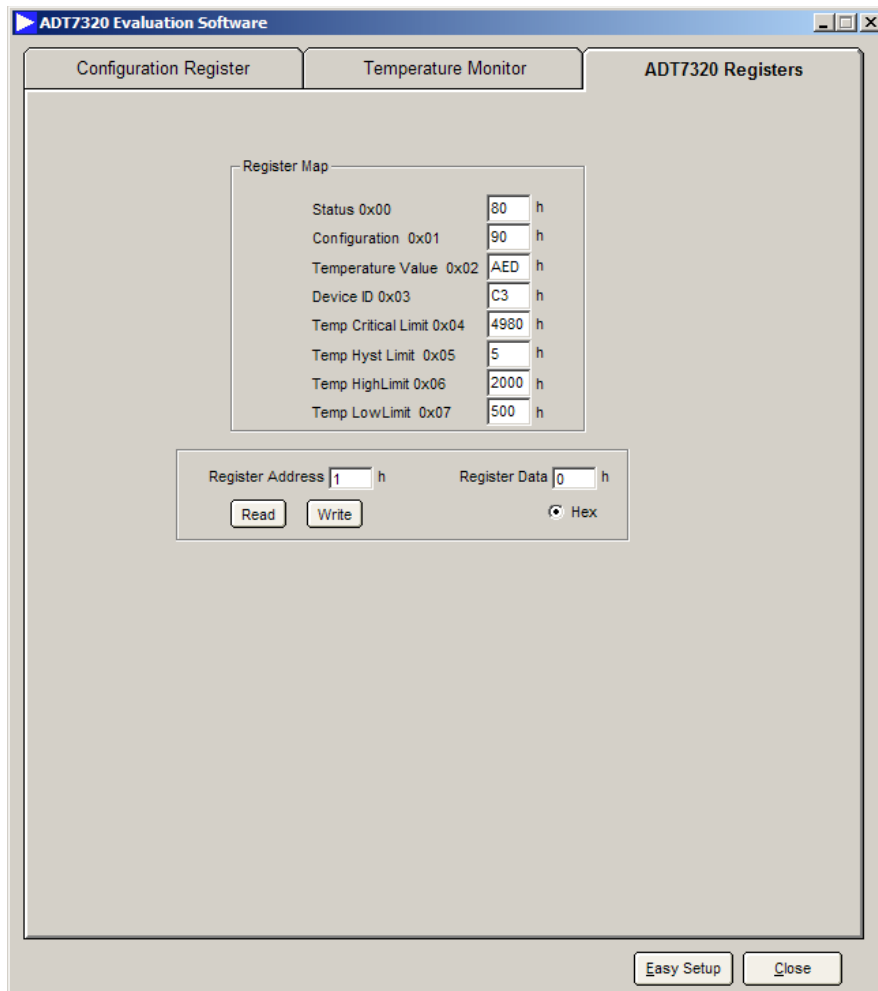

Figure 10. Register Map

WIRING GUIDELINES

Table 1 is a wiring guide for the ADT7320FBZ and Table 2 is a wiring guide for the ADT7420FBZ.

Table 1. ADT7320FBZ Wiring Guide

Color	Reference Designator
Red	VCC
Black	Ground
White	SCLK
Blue	DOUT
Green	DIN
Yellow	\overline{CS}

Table 2. ADT7420FBZ Wiring Guide

Color	Reference Designator
Red	VCC
Black	Ground
White	SCL
Blue	SDA

09023-010

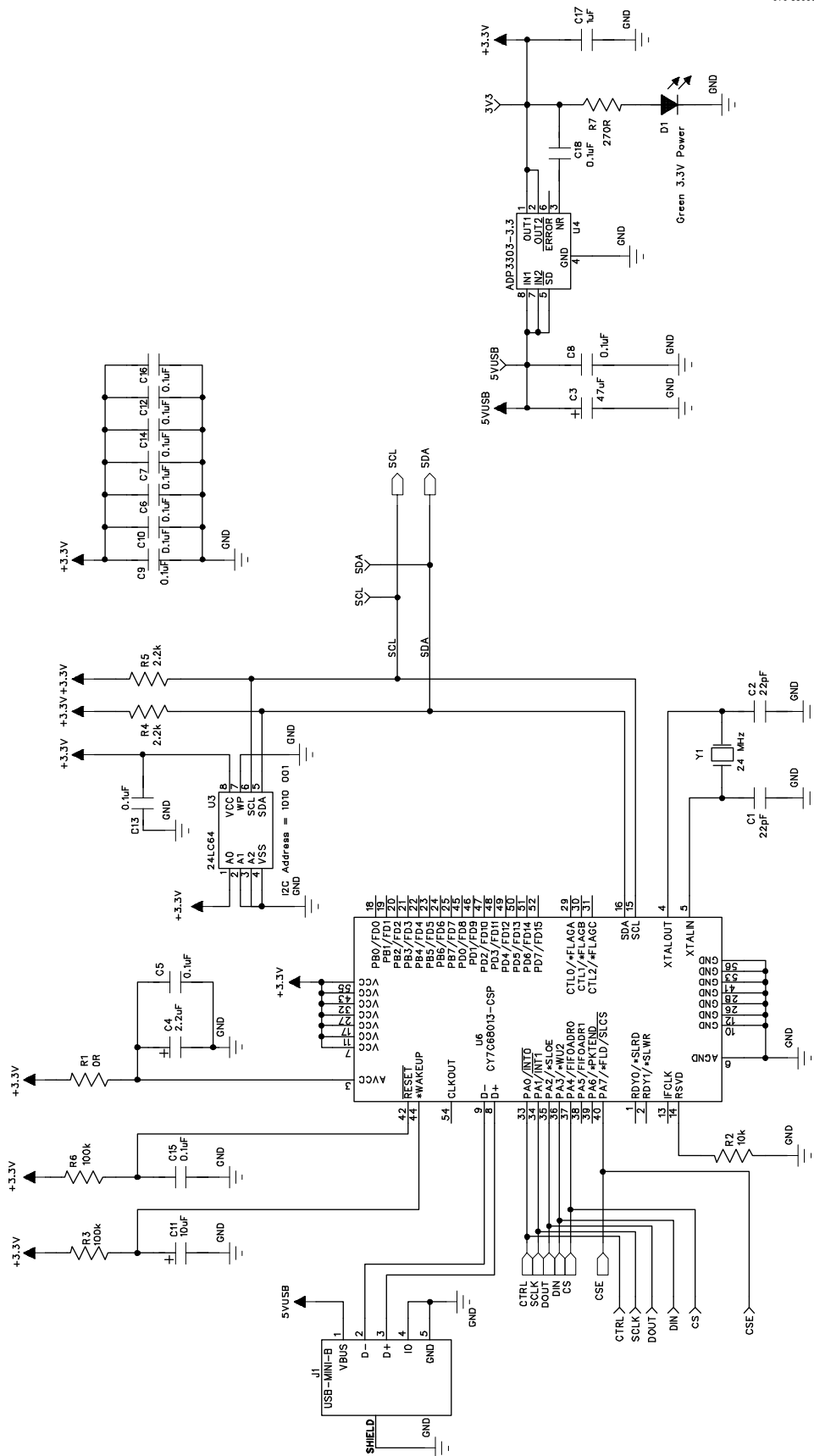

Figure 12. ADT7x20 Evaluation Board Schematic—Main Board USB Controller Circuit

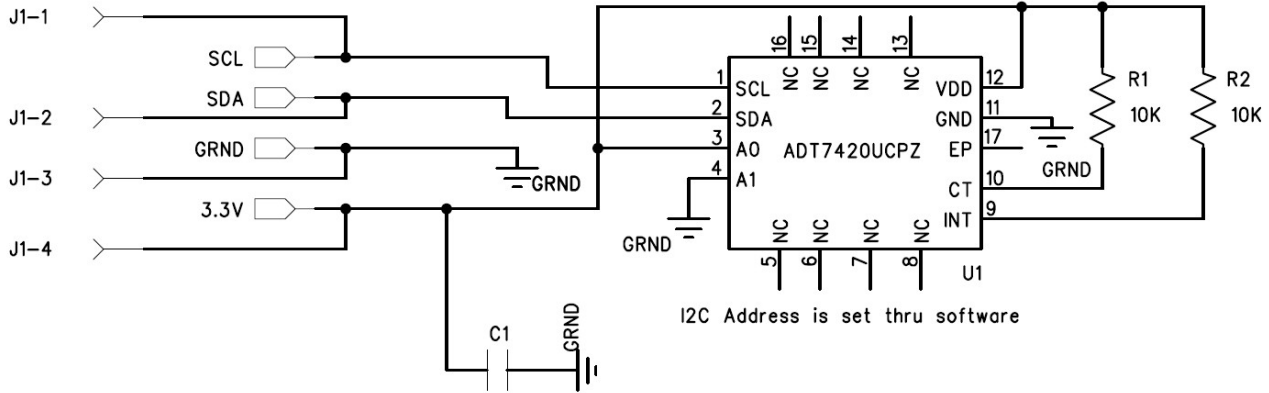

Figure 14. ADT7420FBZ Flex Board

09023-114

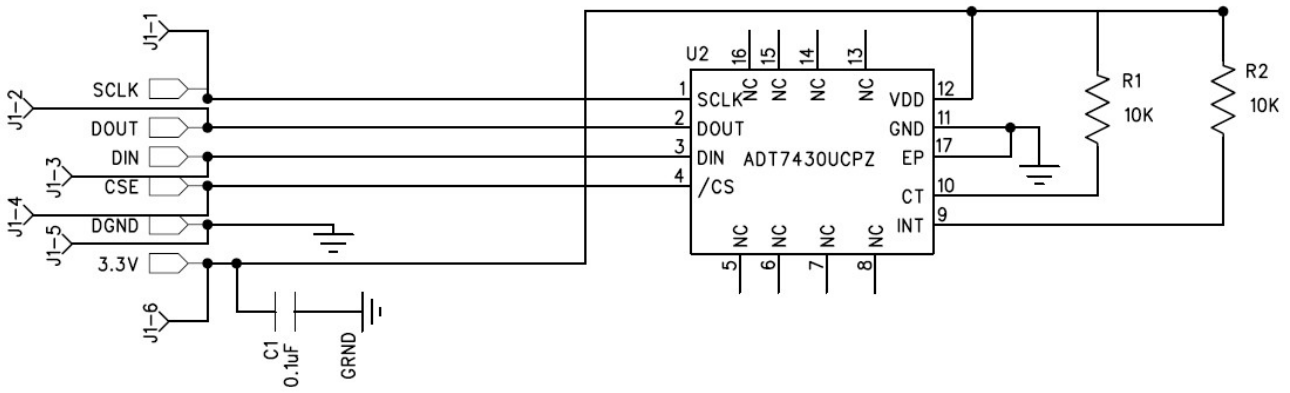

Figure 15. ADT7320FBZ Flex Board

09023-115

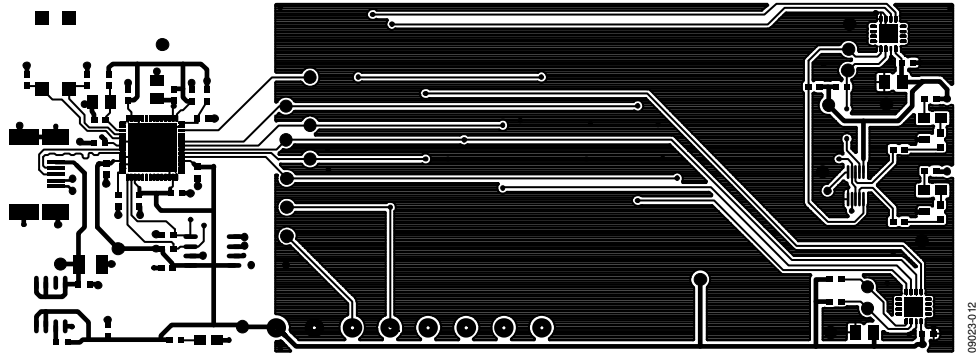

Figure 16. ADT7x20 Evaluation Board—Main Board Component Side (Layer 1)

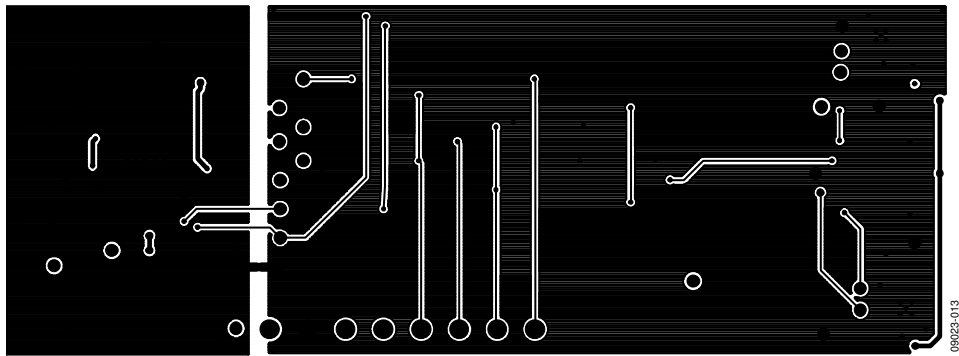

Figure 17. ADT7x20 Evaluation Board—Main Board Solder Side (Layer 2)

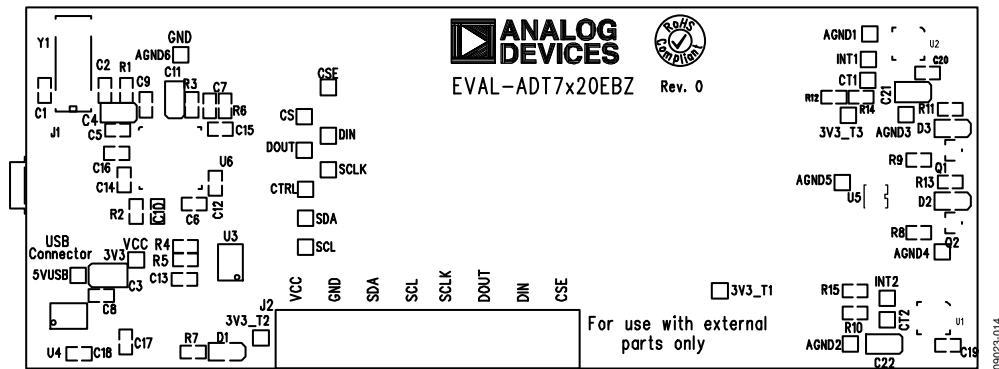

Figure 18. ADT7x20 Evaluation Board—Main Board Silkscreen

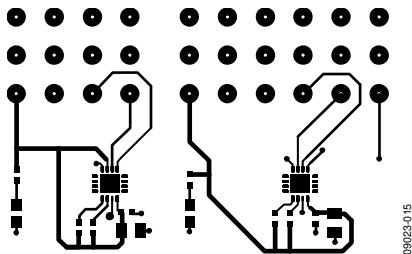

Figure 19. ADT7x20 Evaluation Board External Board Component Side (Layer 1)

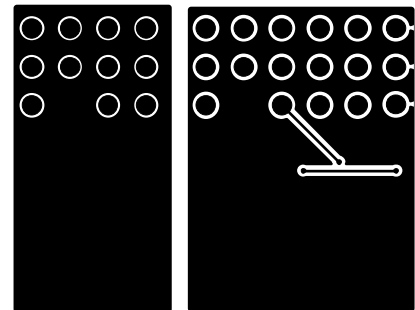

Figure 20. ADT7x20 Evaluation Board External Board Solder Side (Layer 2)

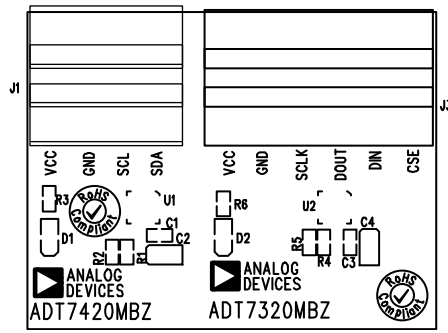

Figure 21. ADT7x20 Evaluation Board External Board Silkscreen

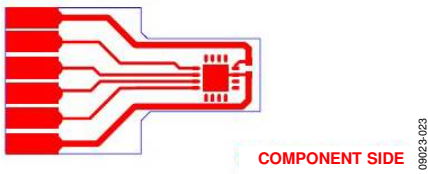

Figure 22. ADT7320FBZ Component Side (Layer 1)

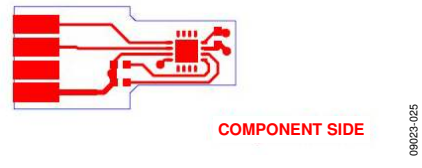

Figure 25. ADT7420FBZ Component Side (Layer 1)

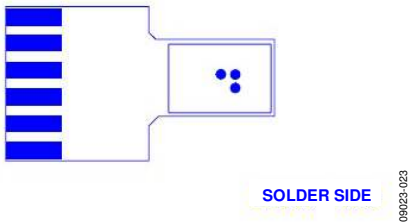

Figure 23. ADT7320FBZ Solder Side (Layer 2)

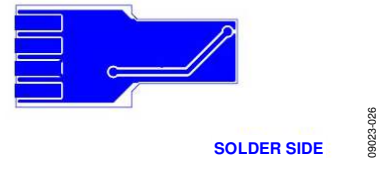

Figure 26. ADT7420FBZ Solder Side (Layer 2)

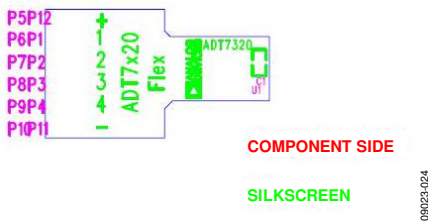

Figure 24. ADT7320FBZ Silkscreen

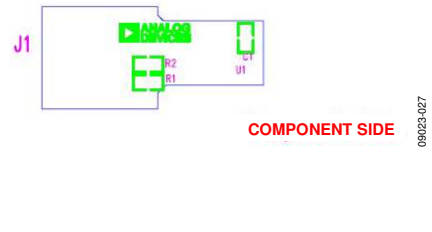

Figure 27. ADT7420FBZ Silkscreen

ORDERING INFORMATION

BILL OF MATERIALS

Table 3. Component Listing—Main Board

Qty.	Reference Designator	Description	Value	Supplier/Ordering No.
2	C1, C2	50 V NPO SMD ceramic capacitor	22 pF	Farnell 722005
1	C3	10 V SMD tantalum capacitor	47 µF	Farnell 1432591
1	C4	10 V SMD tantalum capacitor	2.2 µF	Farnell 498646
14	C5, C6, C7, C8, C9, C10, C12, C13, C14, C15, C16, C18, C19, C20	16 V X7R multilayer ceramic capacitor	0.1 µF	Farnell 1216538
3	C11, C21, C22	10 V SMD tantalum capacitor	10 µF	Farnell 197130
1	C17	10 V dc Y5V ceramic capacitor	1 µF	Farnell 3188840
1	D1	Green LED	VLMP31G2J1	Farnell 1328320
2	D2, D3	Red LED	VLMS31J1K2	Farnell 1328350
1	J1	USB mini-B connector	54819-0579	Digi-Key WM17116CT-ND
1	J2	10-pin terminal block	N/A	Farnell 9632179
2	Q1, Q2	Low power bipolar transistor	BC807	Farnell 1081222
1	R1	SMD resistor	0 Ω	Farnell 772227
1	R2	SMD resistor	10 kΩ	Farnell 9330399
2	R3, R6	SMD resistor	100 kΩ	Farnell 911471
2	R4, R5	SMD resistor	2.2 kΩ	Farnell 196319
3	R7, R11, R13	SMD resistor	270 Ω	Farnell 9331964
6	R8, R9, R10, R12, R14, R15	SMD resistor	10 kΩ	Farnell 911355
1	U1	Temperature sensor IC	ADT7320UPCZ	Analog Devices ADT7320UPCZ
1	U2	Temperature sensor IC	ADT7420UPCZ	Analog Devices ADT7420UPCZ
1	U3	64 kB I ² C serial EEPROM	24LC64	Digi-Key 24LC64-I/SN-ND
1	U4	Precision low dropout voltage regulator	ADP3303AR-3.3	Analog Devices ADP3303ARZ-3.3
1	U5	Dual SPDT switch	ADG787BRMZ	Analog Devices ADG787BRMZ
1	U6	USB microcontroller	CY7C6813-56LFC	Embassy CY7C68013-56LFC
1	Y1	SMD crystal	24 MHz	Farnell 9509658

Table 4. Component Listing—External Board

Qty.	Reference Designator	Description	Value	Supplier/Ordering number
2	C1, C3	16 V X7R multilayer ceramic capacitor	0.1 µF	Farnell 1216538
2	C2, C4	10 V SMD tantalum capacitor	10 µF	Farnell 197130
2	D1, D2	Green LED	VLMP31G2J1	Farnell 1328320
4	R1, R2, R4, R5	SMD resistor	10 kΩ	Farnell 9330399
2	R3, R6	SMD resistor	270 Ω	Farnell 9331964
1	U1	Temperature sensor IC	ADT7320UPCZ	Analog Devices ADT7320UPCZ
1	U2	Temperature sensor IC	ADT7420UPCZ	Analog Devices ADT7420UPCZ

Table 3. Component Listing—ADT7320FBZ Flexi Board

Qty.	Reference Designator	Description	Value	Supplier/Ordering number
1	C1	16 V X7R multilayer ceramic capacitor	0.1 µF	Farnell 1216538
2	R1, R2	SMD resistor	10 kΩ	Farnell 9330399
1	U1	Temperature sensor IC	ADT7320UPCZ	Analog Devices ADT7320UPCZ

Table 4. Component Listing—ADT7420FBZ Flexi Board

Qty.	Reference Designator	Description	Value	Supplier/Ordering number
1	C1	16 V X7R multilayer ceramic capacitor	0.1 µF	Farnell 1216538
2	R1, R2	SMD resistor	10 kΩ	Farnell 9330399
1	U1	Temperature sensor IC	ADT7420UPCZ	Analog Devices ADT7420UPCZ

RELATED LINKS

Resource	Description
ADT7320	Product Page, $\pm 0.25^{\circ}\text{C}$ Accurate, 16-Bit Digital SPI Temperature Sensor
ADT7420	Product Page, $\pm 0.25^{\circ}\text{C}$ Accurate, 16-Bit Digital I ² C Temperature Sensor

I²C refers to a communications protocol originally developed by Philips Semiconductors (now NXP Semiconductors).

**ESD Caution**

ESD (electrostatic discharge) sensitive device. Charged devices and circuit boards can discharge without detection. Although this product features patented or proprietary protection circuitry, damage may occur on devices subjected to high energy ESD. Therefore, proper ESD precautions should be taken to avoid performance degradation or loss of functionality.

Legal Terms and Conditions

By using the evaluation board discussed herein (together with any tools, components documentation or support materials, the "Evaluation Board"), you are agreeing to be bound by the terms and conditions set forth below ("Agreement") unless you have purchased the Evaluation Board, in which case the Analog Devices Standard Terms and Conditions of Sale shall govern. Do not use the Evaluation Board until you have read and agreed to the Agreement. Your use of the Evaluation Board shall signify your acceptance of the Agreement. This Agreement is made by and between you ("Customer") and Analog Devices, Inc. ("ADI"), with its principal place of business at One Technology Way, Norwood, MA 02062, USA. Subject to the terms and conditions of the Agreement, ADI hereby grants to Customer a free, limited, personal, temporary, non-exclusive, non-sublicensable, non-transferable license to use the Evaluation Board FOR EVALUATION PURPOSES ONLY. Customer understands and agrees that the Evaluation Board is provided for the sole and exclusive purpose referenced above, and agrees not to use the Evaluation Board for any other purpose. Furthermore, the license granted is expressly made subject to the following additional limitations: Customer shall not (i) rent, lease, display, sell, transfer, assign, sublicense, or distribute the Evaluation Board; and (ii) permit any Third Party to access the Evaluation Board. As used herein, the term "Third Party" includes any entity other than ADI, Customer, their employees, affiliates and in-house consultants. The Evaluation Board is NOT sold to Customer; all rights not expressly granted herein, including ownership of the Evaluation Board, are reserved by ADI. CONFIDENTIALITY. This Agreement and the Evaluation Board shall all be considered the confidential and proprietary information of ADI. Customer may not disclose or transfer any portion of the Evaluation Board to any other party for any reason. Upon discontinuation of use of the Evaluation Board or termination of this Agreement, Customer agrees to promptly return the Evaluation Board to ADI. ADDITIONAL RESTRICTIONS. Customer may not disassemble, decompile or reverse engineer chips on the Evaluation Board. Customer shall inform ADI of any occurred damages or any modifications or alterations it makes to the Evaluation Board, including but not limited to soldering or any other activity that affects the material content of the Evaluation Board. Modifications to the Evaluation Board must comply with applicable law, including but not limited to the RoHS Directive. TERMINATION. ADI may terminate this Agreement at any time upon giving written notice to Customer. Customer agrees to return to ADI the Evaluation Board at that time. LIMITATION OF LIABILITY. THE EVALUATION BOARD PROVIDED HEREUNDER IS PROVIDED "AS IS" AND ADI MAKES NO WARRANTIES OR REPRESENTATIONS OF ANY KIND WITH RESPECT TO IT. ADI SPECIFICALLY DISCLAIMS ANY REPRESENTATIONS, ENDORSEMENTS, GUARANTEES, OR WARRANTIES, EXPRESS OR IMPLIED, RELATED TO THE EVALUATION BOARD INCLUDING, BUT NOT LIMITED TO, THE IMPLIED WARRANTY OF MERCHANTABILITY, TITLE, FITNESS FOR A PARTICULAR PURPOSE OR NON-INFRINGEMENT OF INTELLECTUAL PROPERTY RIGHTS. IN NO EVENT WILL ADI AND ITS LICENSORS BE LIABLE FOR ANY INCIDENTAL, SPECIAL, INDIRECT, OR CONSEQUENTIAL DAMAGES RESULTING FROM CUSTOMER'S POSSESSION OR USE OF THE EVALUATION BOARD, INCLUDING BUT NOT LIMITED TO LOST PROFITS, DELAY COSTS, LABOR COSTS OR LOSS OF GOODWILL. ADI'S TOTAL LIABILITY FROM ANY AND ALL CAUSES SHALL BE LIMITED TO THE AMOUNT OF ONE HUNDRED US DOLLARS (\$100.00). EXPORT. Customer agrees that it will not directly or indirectly export the Evaluation Board to another country, and that it will comply with all applicable United States federal laws and regulations relating to exports. GOVERNING LAW. This Agreement shall be governed by and construed in accordance with the substantive laws of the Commonwealth of Massachusetts (excluding conflict of law rules). Any legal action regarding this Agreement will be heard in the state or federal courts having jurisdiction in Suffolk County, Massachusetts, and Customer hereby submits to the personal jurisdiction and venue of such courts. The United Nations Convention on Contracts for the International Sale of Goods shall not apply to this Agreement and is expressly disclaimed.

©2012–2014 Analog Devices, Inc. All rights reserved. Trademarks and registered trademarks are the property of their respective owners. UG09023-0-10/14(B)



www.analog.com