

PAGE 1/2	ISSUE 22-11-16D	SERIES ATTENUATEUR	PART NUMBER R411716124
----------	-----------------	-----------------------	------------------------

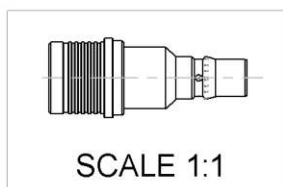

All dimensions are in mm.

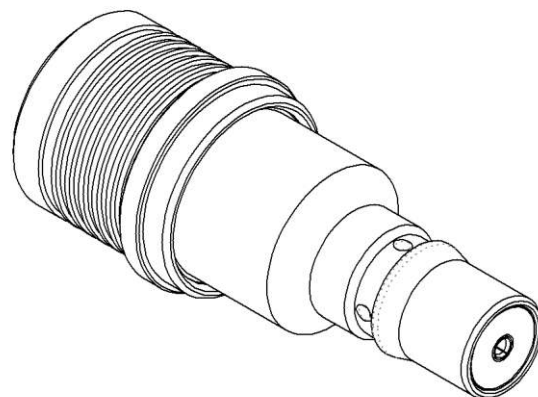
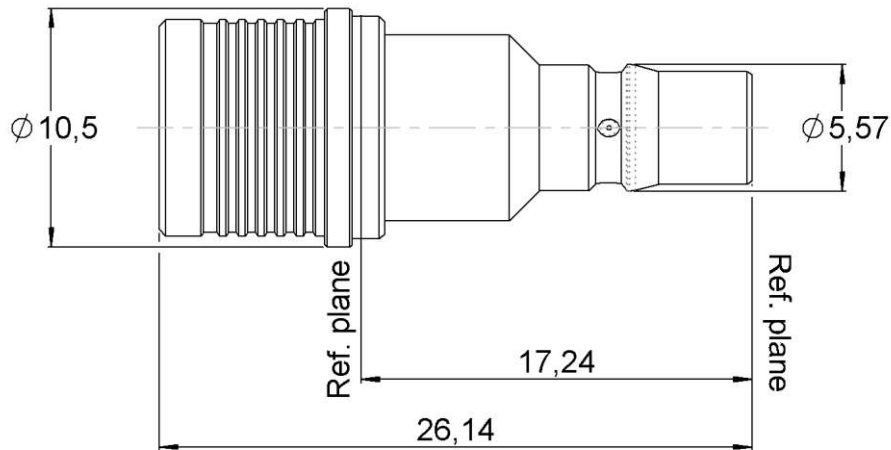
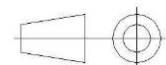

COMPONENTS	MATERIALS	PLATING ( $\mu\text{m}$ )
Body	<b>BRASS</b>	<b>BBR</b>
Male center contact	<b>BRASS</b>	<b>GOLD OVER COPPER</b>
Female center contact	<b>BERYLLIUM COPPER</b>	<b>GOLD OVER COPPER</b>
Outer contact	<b>BRONZE</b>	<b>BBR</b>
Insulator	<b>PTFE</b>	
Gasket	-	
Substrate	<b>ALUMINA</b>	
Resistor	<b>THICK FILM</b>	
Others parts	-	

PAGE 2/2	ISSUE <b>22-11-16D</b>	SERIES <b>ATTENUATEUR</b>	PART NUMBER <b>R411716124</b>
----------	------------------------	------------------------------	-------------------------------

**ELECTRICAL CHARACTERISTICS**

Frequency (GHz)	<b>DC - 2</b>	<b>2 - 6</b>
V.S.W.R (≤)	<b>1.20</b>	<b>1.30</b>
Deviation(±dB)	<b>0.70</b>	<b>0.70</b>

Operating Frequency Range	<b>DC - 6</b>	GHz
Impedance	<b>50</b>	Ω
Nominal Attenuation	<b>16</b>	dB
Peak power at 25°C (1μs, 1%)	<b>100</b>	W
Average power at 25°C	<b>1</b>	W (Free Air Cooled)
		W (Conduction Cooled)

**MECHANICAL CHARACTERISTICS**

Connectors	<b>QMA</b>	<b>Male Female</b>
Weight	<b>6,2610</b> g	

**ENVIRONMENTAL CHARACTERISTICS**

Operating temperature range	<b>-40/+85</b> °C
Storage temperature range	<b>-40/+85</b> °C

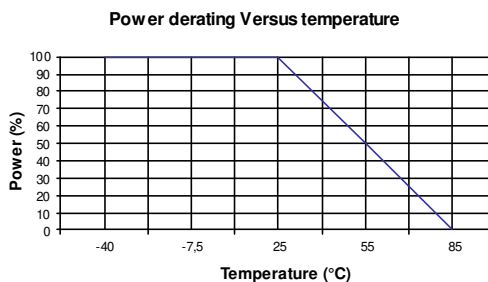

**SPECIFICATION**

**OTHER CHARACTERISTICS**