

42731-2 ✓ ACTIVE

FASTON | FASTON 250

TE Internal #: 42731-2

Quick Disconnects, Receptacle, 22 – 18 AWG Wire Size, .32 – .82 mm² Wire Size, Mating Tab Width 6.35 mm [.25 in], Straight, Brass, FASTON 250

[View on TE.com >](#)



Terminals & Splices > Quick Disconnects

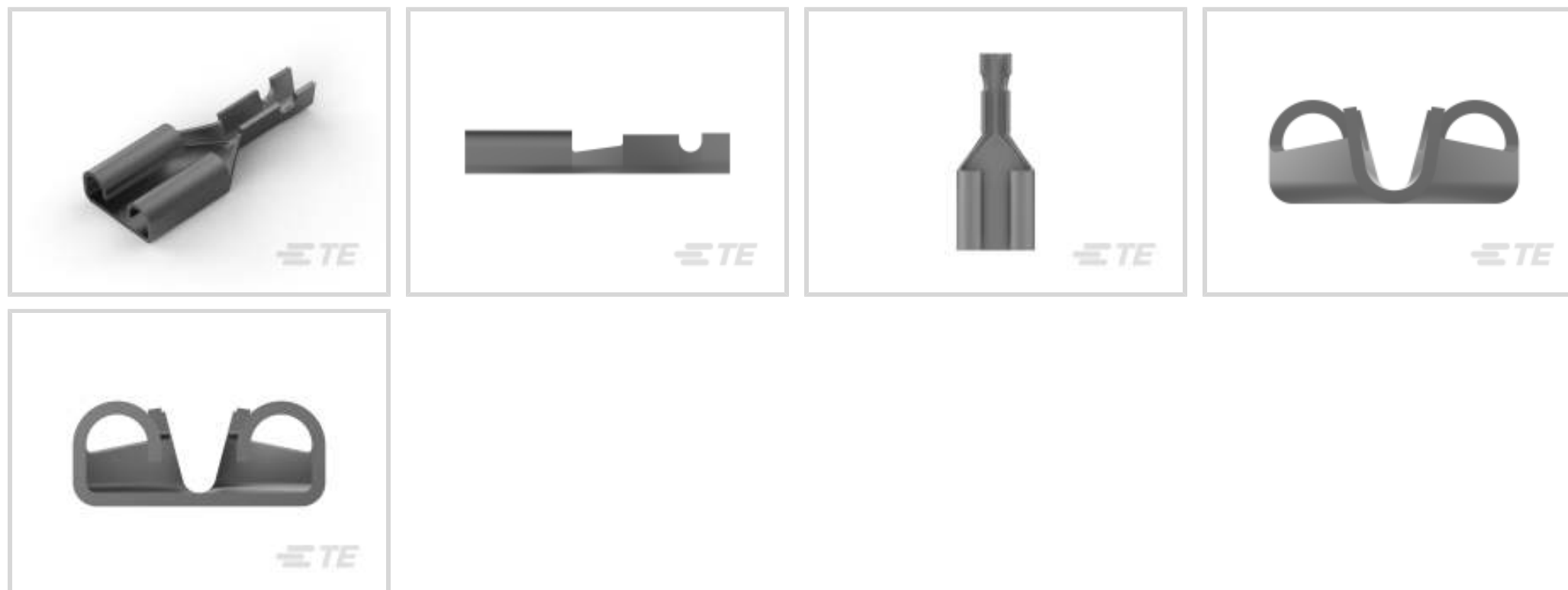

Quick Disconnect Terminal Type: **Receptacle**

Wire Size: .32 – .82 mm²

Mating Tab Width: 6.35 mm [.25 in]

Mating Tab Thickness: .81 mm [.032 in]

Features

Product Type Features

Insertion Force	Low
-----------------	-----

Configuration Features

Connection Capacity	Single
---------------------	--------

Compatible With Wire & Cable Type	Discrete Wire
-----------------------------------	---------------

Contact Features

Quick Disconnect Terminal Type	Receptacle
--------------------------------	------------

Mating Tab Width	6.35 mm [.25 in]
------------------	------------------

Mating Tab Thickness	.81 mm [.032 in]
----------------------	------------------

Terminal Orientation	Straight
----------------------	----------

Contact Base Material	Brass
-----------------------	-------

Terminal Plating Material	Tin
---------------------------	-----

Crimp Type	F-Crimp
------------	---------

Barrel Type	Open
-------------	------

Termination Features



Product Terminates To	Wire & Cable
-----------------------	--------------

Mechanical Attachment

Wire Insulation Support	With
Mating Retention Type	Dimple

Dimensions

Terminal Material Thickness	.41 mm[.016 in]
Product Length	20.32 mm[.8 in]
Compatible Insulation Diameter Range	1.52 – 2.54 mm[.06 – .1 in]
Wire Size	.32 – .82 mm ²

Usage Conditions

Insulation Option	Uninsulated
Operating Temperature Range	-40 – 110 °C[-40 – 230 °F]

Industry Standards

Agency/Standard	CSA, UL
-----------------	---------

Packaging Features

Packaging Quantity	500
Packaging Method	Loose Piece/Carton

Other

Line	Premier
------	---------

Product Compliance

[For compliance documentation, visit the product page on TE.com>](#)

EU RoHS Directive 2011/65/EU	Compliant
EU ELV Directive 2000/53/EC	Compliant
China RoHS 2 Directive MIIT Order No 32, 2016	No Restricted Materials Above Threshold
EU REACH Regulation (EC) No. 1907/2006	Current ECHA Candidate List: JUNE 2023 (235) Candidate List Declared Against: JUNE 2023 (235) Does not contain REACH SVHC
Halogen Content	Low Halogen - Br, Cl, F, I < 900 ppm per homogenous material. Also BFR/CFR/PVC Free
Solder Process Capability	Not applicable for solder process capability

Product Compliance Disclaimer

This information is provided based on reasonable inquiry of our suppliers and represents our current actual knowledge based on the information they provided. This information is subject to change. The part numbers that TE has identified as EU RoHS compliant have a maximum concentration of 0.1% by weight in homogenous materials for lead, hexavalent chromium, mercury, PBB, PBDE, DBP, BBP, DEHP, DIBP, and 0.01% for cadmium, or qualify for an exemption to these limits as defined in the Annexes of Directive 2011/65/EU (RoHS2). Finished electrical and electronic equipment products will be CE marked as required by Directive 2011/65/EU. Components may not be CE marked. Additionally, the part numbers that TE has identified as EU ELV compliant have a maximum concentration of 0.1% by weight in homogenous materials for lead, hexavalent chromium, and mercury, and 0.01% for cadmium, or qualify for an exemption to these limits as defined in the Annexes of Directive 2000/53/EC (ELV). Regarding the REACH Regulation, the information TE provides on SVHC in articles for this part number is based on the latest European Chemicals Agency (ECHA) 'Guidance on requirements for substances in articles' posted at this URL: <https://echa.europa.eu/guidance-documents/guidance-on-reach>

Compatible Parts



TE Part # 42025-4
250 FASTON REC 18-16 AWG TPBR



TE Part # 2-171706-1
FASTON 250 INS POD NYLON NAT



TE Part # 5-160563-2
250 FASTON REC 18-16 AWG TPBR



TE Part # 90166-1
DAHT 250 FASTON REC 22-18 ASSY



TE Part # 91514-1
CCII FASTON 250 REC 22-18 ASSY

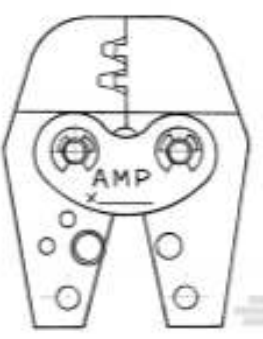

TE Part # 752856-1
DIES 90166-1

Also in the Series | FASTON 250



Compression Connectors(4)



Crimp Terminal Housings(142)



Insertion & Extraction Tools(6)



Magnet Wire Terminals(1)



PCB Terminals(135)

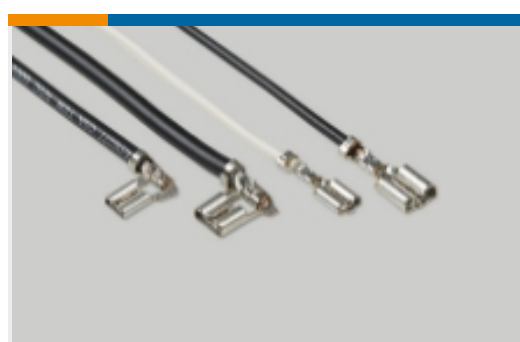

Quick Disconnects(445)



Splices(4)

Customers Also Bought

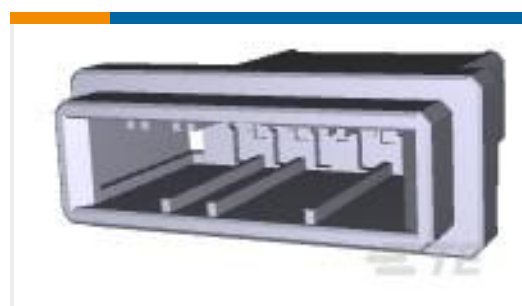

TE Part #1-177648-5
D3100S DYNAMIC W-T-W TAB HSG



TE Part #5-160321-2
FASTON 110 REC 22-20 AWG
ELECTRO TPBR

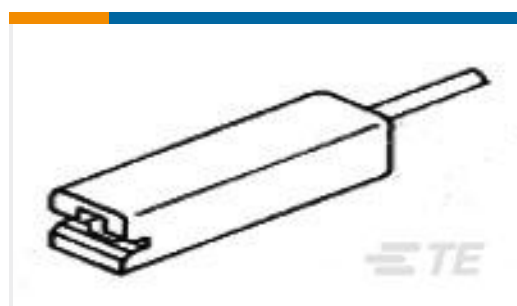

TE Part #1-480417-0
110 FASTON HSG.,REC.,1 POS,
NATRUAL



TE Part #280232-8
250 FASTON POST INS.,REC.,1 POS,
NATRUAL



TE Part #1939588-1
DYNAMIC D-1000 KEYING PLUG

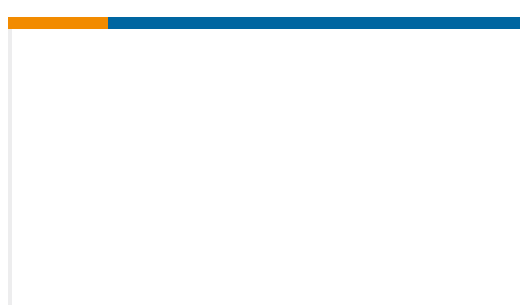

TE Part #1762130-1
SAHT DYNAMIC D4-M 16-14 ASSY

Documents

Product Drawings

[FASTON 250 REC TERMINAL 22-18 TPBR LP](#)

English

CAD Files

[3D PDF](#)

3D

Customer View Model

[ENG_CVM_CVM_42731-2_H.2d_dxf.zip](#)

English

Customer View Model

[ENG_CVM_CVM_42731-2_H.3d_igs.zip](#)

English

Customer View Model

[ENG_CVM_CVM_42731-2_H.3d_stp.zip](#)

English

[3D PDF](#)



English

Customer View Model

[ENG_CVM_42731-2_B.2d_dxf.zip](#)

English

Customer View Model

[ENG_CVM_42731-2_B.3d_igs.zip](#)

English

Customer View Model

[ENG_CVM_42731-2_B.3d_stp.zip](#)

English

By downloading the CAD file I accept and agree to the [Terms and Conditions](#) of use.

Product Specifications

[.110,.187 & 250 Series FASTON Terminals](#)

English

Product Specification

English

Product Environmental Compliance

Product Compliance

English

Product Compliance

English

Instruction Sheets

Instruction Sheet (U.S.)

English

Crimping Head for FASTON Terminals

English