

# GenX3™ 600V IGBTs with Diode

## IXGH60N60C3D1 IXGT60N60C3D1\*

\*Obsolete Part Number

$V_{CES} = 600V$   
 $I_{C110} = 60A$   
 $V_{CE(sat)} \leq 2.5V$   
 $t_{fi} (typ) = 50ns$

High Speed PT IGBTs for  
40-100kHz switching

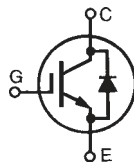

Symbol	Test Conditions	Maximum Ratings	
$V_{CES}$	$T_J = 25^\circ C$ to $150^\circ C$	600	V
$V_{CGR}$	$T_J = 25^\circ C$ to $150^\circ C$ , $R_{GE} = 1M\Omega$	600	V
$V_{GES}$	Continuous	$\pm 20$	V
$V_{GEM}$	Transient	$\pm 30$	V
$I_{C25}$	$T_C = 25^\circ C$ , (Limited by Leads)	75	A
$I_{C110}$	$T_C = 110^\circ C$	60	A
$I_{F110}$	$T_C = 110^\circ C$	26	A
$I_{CM}$	$T_C = 25^\circ C$ , 1ms	300	A
$I_A$	$T_C = 25^\circ C$	40	A
$E_{AS}$	$T_C = 25^\circ C$	400	mJ
<b>SSOA</b> <b>(RBSOA)</b>	$V_{GE} = 15V$ , $T_{VJ} = 125^\circ C$ , $R_G = 3\Omega$ Clamped Inductive Load	$I_{CM} = 125$ $V_{CE} \leq V_{CES}$	A
$P_C$	$T_C = 25^\circ C$	380	W
$T_J$		-55 ... +150	$^\circ C$
$T_{JM}$		150	$^\circ C$
$T_{stg}$		-55 ... +150	$^\circ C$
$T_L$	Maximum Lead Temperature for Soldering	300	$^\circ C$
$T_{SOLD}$	1.6 mm (0.062in.) from Case for 10s	260	$^\circ C$
$M_d$	Mounting Torque (TO-247)	1.13/10	Nm/lb.in.
<b>Weight</b>	TO-268	4	g
	TO-247	6	g

TO-247 (IXGH)

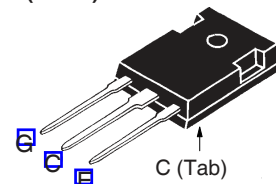

TO-268 (IXGT)

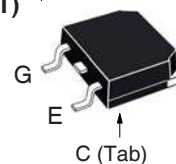

G = Gate      C = Collector  
E = Emitter    Tab = Collector

### Features

- Optimized for Low Switching Losses
- Square RBSOA
- High Avalanche Capability
- Anti-Parallel Ultra Fast Diode
- International Standard Packages

### Advantages

- High Power Density
- Low Gate Drive Requirement

### Applications

- High Frequency Power Inverters
- UPS
- Motor Drives
- SMPS
- PFC Circuits
- Battery Chargers
- Welding Machines
- Lamp Ballasts

Symbol	Test Conditions ( $T_J = 25^\circ C$ , Unless Otherwise Specified)	Characteristic Values		
		Min.	Typ.	Max.
$V_{GE(th)}$	$I_C = 250\mu A$ , $V_{CE} = V_{GE}$	3.0		5.5 V
$I_{CES}$	$V_{CE} = V_{CES}$ , $V_{GE} = 0V$ $T_J = 125^\circ C$			50 $\mu A$ 1 mA
$I_{GES}$	$V_{CE} = 0V$ , $V_{GE} = \pm 20V$			$\pm 100$ nA
$V_{CE(sat)}$	$I_C = 40A$ , $V_{GE} = 15V$ $T_J = 125^\circ C$		2.2 1.7	2.5 V V

Symbol	Test Conditions ( $T_J = 25^\circ\text{C}$ , Unless Otherwise Specified)	Characteristic Values		
		Min.	Typ.	Max.
$g_{fs}$	$I_C = 40\text{A}$ , $V_{CE} = 10\text{V}$ , Note 1	23	38	S
$C_{ies}$	$V_{CE} = 25\text{V}$ , $V_{GE} = 0\text{V}$ , $f = 1\text{MHz}$		2810	pF
$C_{oes}$			210	pF
$C_{res}$			80	pF
$Q_g$	$I_C = 40\text{A}$ , $V_{GE} = 15\text{V}$ , $V_{CE} = 0.5 \cdot V_{CES}$		115	nC
$Q_{ge}$			22	nC
$Q_{gc}$			43	nC
$t_{d(on)}$	<b>Inductive Load, <math>T_J = 125^\circ\text{C}</math></b> $I_C = 40\text{A}$ , $V_{GE} = 15\text{V}$ $V_{CE} = 480\text{V}$ , $R_G = 3\Omega$ Note 2		21	ns
$t_{ri}$			33	ns
$E_{on}$			0.80	mJ
$t_{d(off)}$			70	110 ns
$t_{fi}$			50	ns
$E_{off}$			0.45	0.80 mJ
$t_{d(on)}$	<b>Inductive Load, <math>T_J = 125^\circ\text{C}</math></b> $I_C = 40\text{A}$ , $V_{GE} = 15\text{V}$ $V_{CE} = 480\text{V}$ , $R_G = 3\Omega$ Note 2		21	ns
$t_{ri}$			33	ns
$E_{on}$			1.25	mJ
$t_{d(off)}$			112	ns
$t_{fi}$			86	ns
$E_{off}$			0.80	mJ
$R_{thJC}$			0.33	$^\circ\text{C/W}$
$R_{thCK}$		0.21		$^\circ\text{C/W}$

**TO-268 (IXGT) Outline**

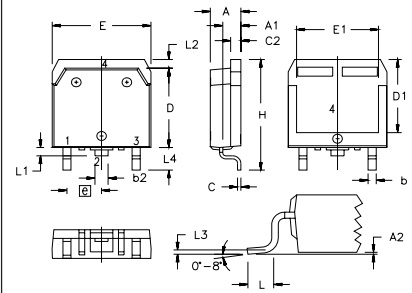

Terminals: 1 - Gate 2 - Collector  
3 - Emitter Tab - Collector

SYM	INCHES		MILLIMETERS	
	MIN	MAX	MIN	MAX
A	.193	.201	4.90	5.10
A1	.106	.114	2.70	2.90
A2	.001	.010	0.02	0.25
b	.045	.057	1.15	1.45
b2	.075	.083	1.90	2.10
C	.016	.026	0.40	0.65
C2	.057	.063	1.45	1.60
D	.543	.551	13.80	14.00
D1	.488	.500	12.40	12.70
E	.624	.632	15.85	16.05
E1	.524	.535	13.30	13.60
e	.215 BSC		5.45 BSC	
H	.736	.752	18.70	19.10
L	.094	.106	2.40	2.70
L1	.047	.055	1.20	1.40
L2	.039	.045	1.00	1.15
L3	.010 BSC		0.25 BSC	
L4	.150	.161	3.80	4.10

**Reverse Diode (FRED)**

Symbol	Test Conditions ( $T_J = 25^\circ\text{C}$ , Unless Otherwise Specified)	Characteristic Values		
		Min.	Typ.	Max.
$V_F$	$I_F = 30\text{A}$ , $V_{GE} = 0\text{V}$ , Note 1 $T_J = 150^\circ\text{C}$		1.6	2.7 V
$I_{RM}$	$I_F = 30\text{A}$ , $V_{GE} = 0\text{V}$ , $di_F/dt = 100\text{ A}/\mu\text{s}$ , $T_J = 100^\circ\text{C}$ $V_R = 100\text{V}$ , $T_J = 100^\circ\text{C}$ $I_F = 1\text{A}$ ; $-di/dt = 100\text{ A}/\mu\text{s}$ , $V_R = 30\text{V}$			4 A
$t_{rr}$			100	ns
			25	ns
$R_{thJC}$				0.9 $^\circ\text{C/W}$

Notes:

1. Pulse test,  $t \leq 300\mu\text{s}$ , duty cycle,  $d \leq 2\%$ .
2. Switching times & energy losses may increase for higher  $V_{CE}(\text{Clamp})$ ,  $T_J$  or  $R_G$ .

**TO-247 (IXGH) Outline**

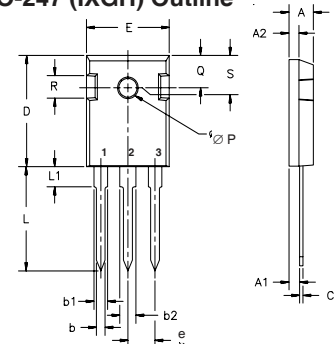

Terminals: 1 - Gate 2 - Collector  
3 - Emitter Tab - Collector

Dim.	Millimeter		Inches	
	Min.	Max.	Min.	Max.
A	4.7	5.3	.185	.209
A <sub>1</sub>	2.2	2.54	.087	.102
A <sub>2</sub>	2.2	2.6	.059	.098
b	1.0	1.4	.040	.055
b <sub>1</sub>	1.65	2.13	.065	.084
b <sub>2</sub>	2.87	3.12	.113	.123
C	.4	.8	.016	.031
D	20.80	21.46	.819	.845
E	15.75	16.26	.610	.640
e	5.20	5.72	0.205	0.225
L	19.81	20.32	.780	.800
L1		4.50		.177
∅P	3.55	3.65	.140	.144
Q	5.89	6.40	0.232	0.252
R	4.32	5.49	.170	.216
S	6.15 BSC		.242 BSC	

IXYS Reserves the Right to Change Limits, Test Conditions, and Dimensions.

IXYS MOSFETs and IGBTs are covered by one or more of the following U.S. patents:	4,835,592	4,931,844	5,049,961	5,237,481	6,162,665	6,404,065 B1	6,683,344	6,727,585	7,005,734 B2	7,157,338B2
	4,850,072	5,017,508	5,063,307	5,381,025	6,259,123 B1	6,534,343	6,710,405 B2	6,759,692	7,063,975 B2	
	4,881,106	5,034,796	5,187,117	5,486,715	6,306,728 B1	6,583,505	6,710,463	6,771,478 B2	7,071,537	

**Fig. 1. Output Characteristics @  $T_J = 25^\circ\text{C}$**

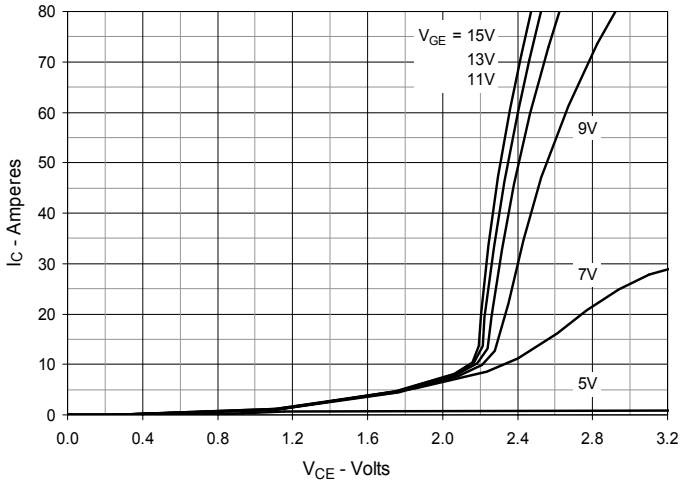

**Fig. 2. Extended Output Characteristics @  $T_J = 25^\circ\text{C}$**

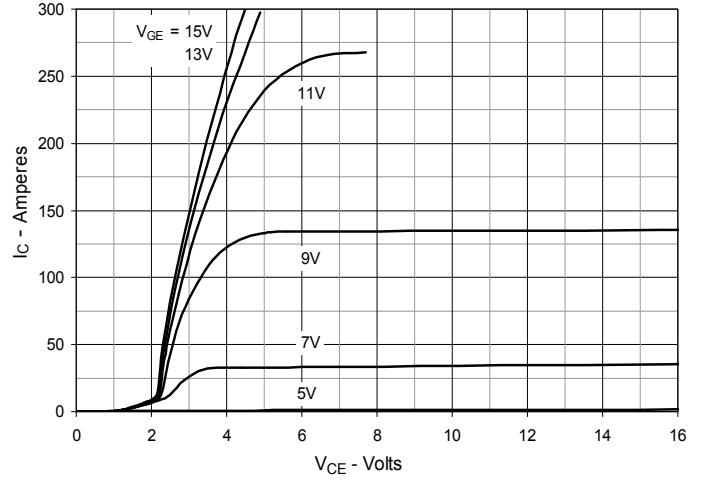

**Fig. 3. Output Characteristics @  $T_J = 125^\circ\text{C}$**

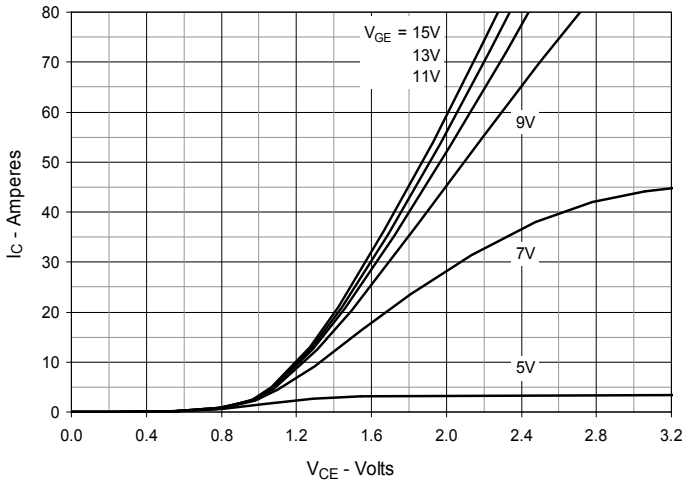

**Fig. 4. Dependence of  $V_{CE(sat)}$  on Junction Temperature**

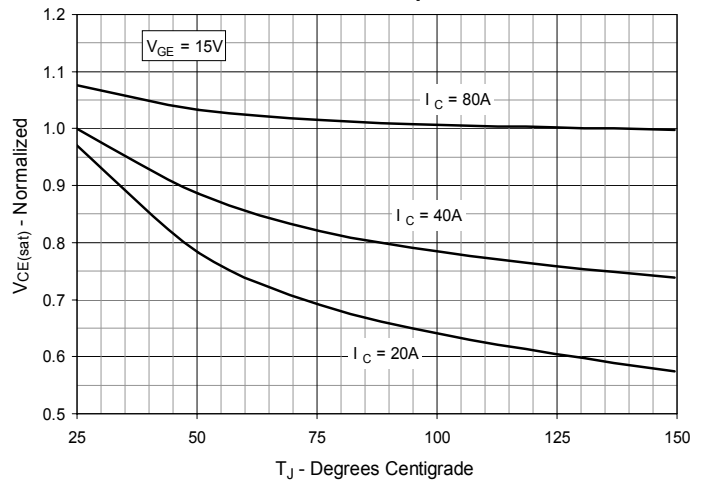

**Fig. 5. Collector-to-Emitter Voltage vs. Gate-to-Emitter Voltage**

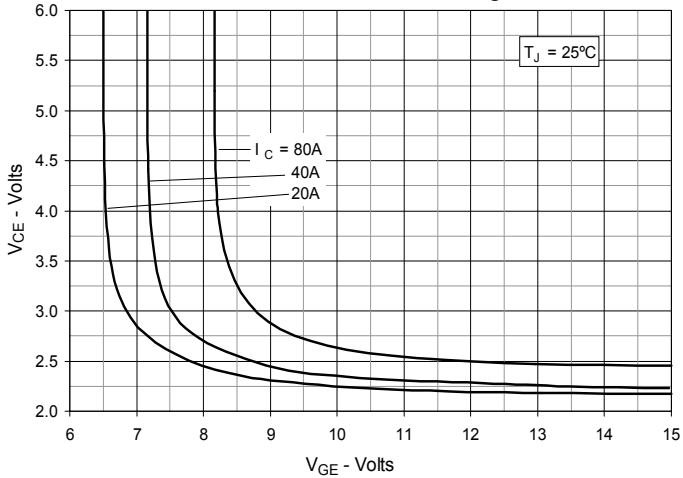

**Fig. 6. Input Admittance**

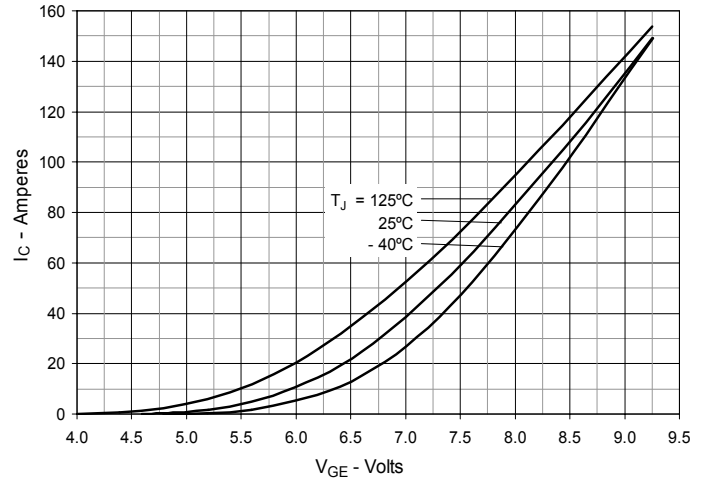

**Fig. 7. Transconductance**

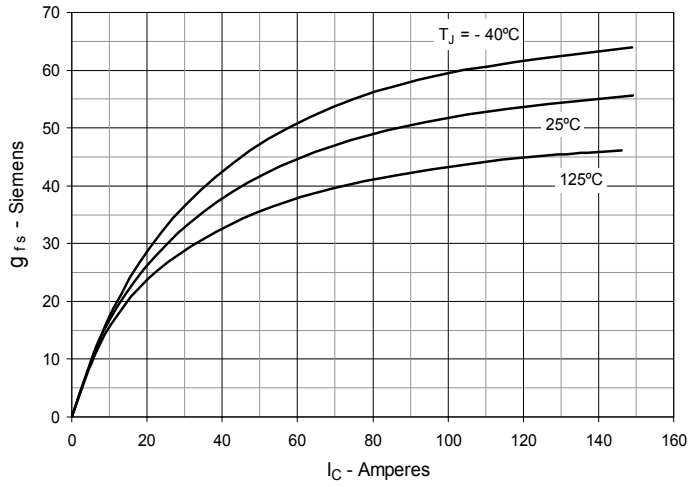

**Fig. 8. Gate Charge**

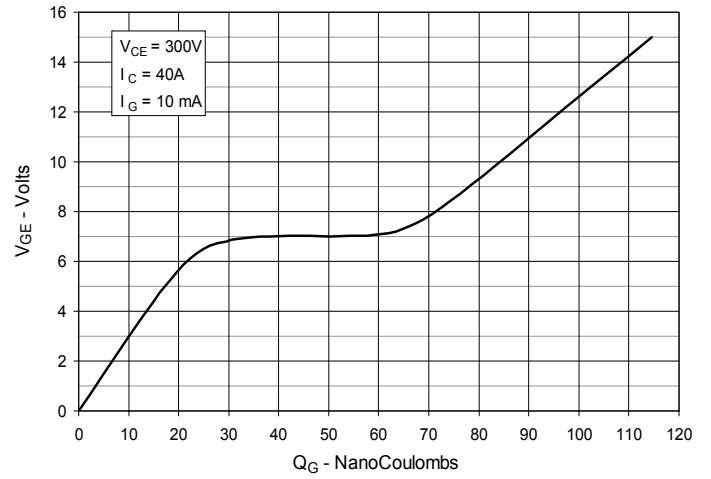

**Fig. 9. Capacitance**

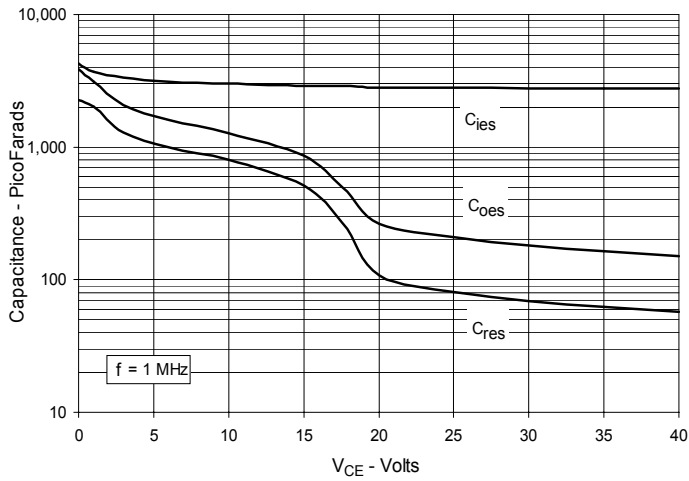

**Fig. 10. Reverse-Bias Safe Operating Area**

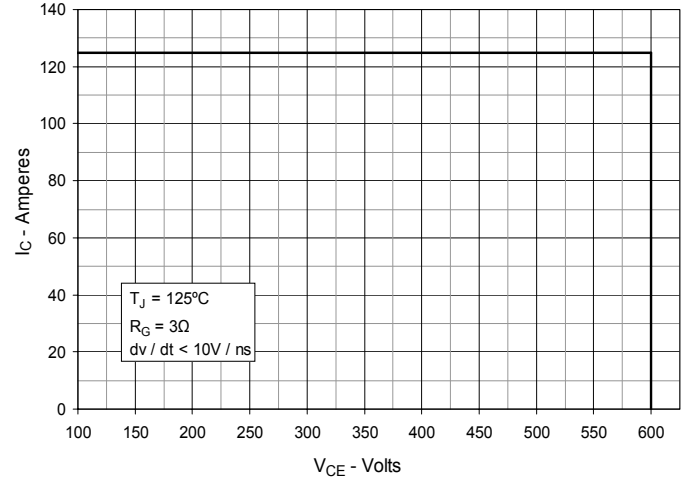

**Fig. 11. Maximum Transient Thermal Impedance**

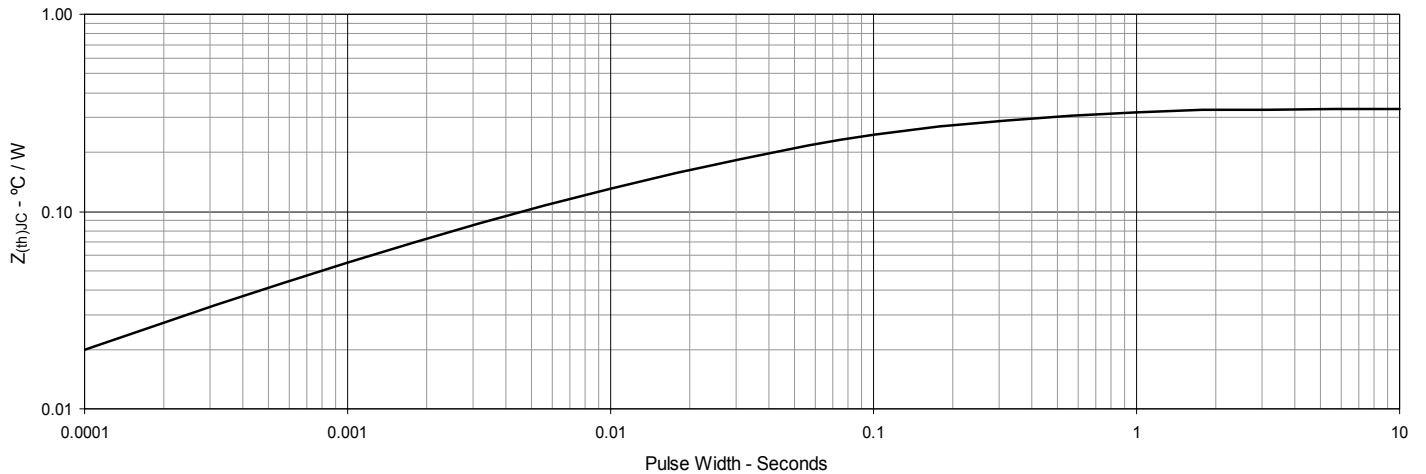

**Fig. 12. Inductive Switching Energy Loss vs. Gate Resistance**

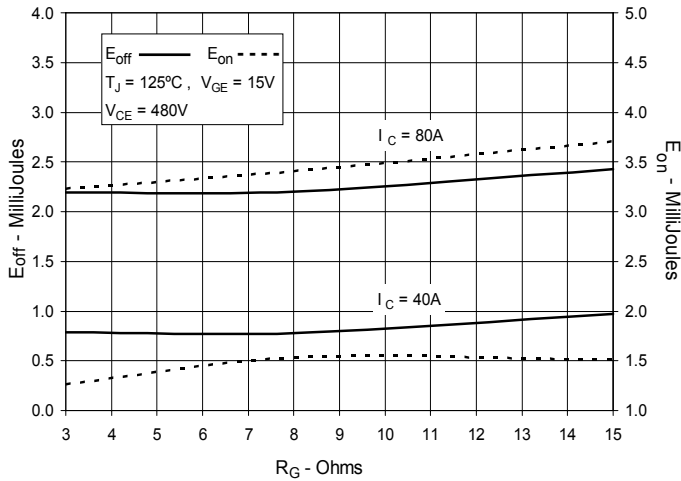

**Fig. 13. Inductive Switching Energy Loss vs. Collector Current**

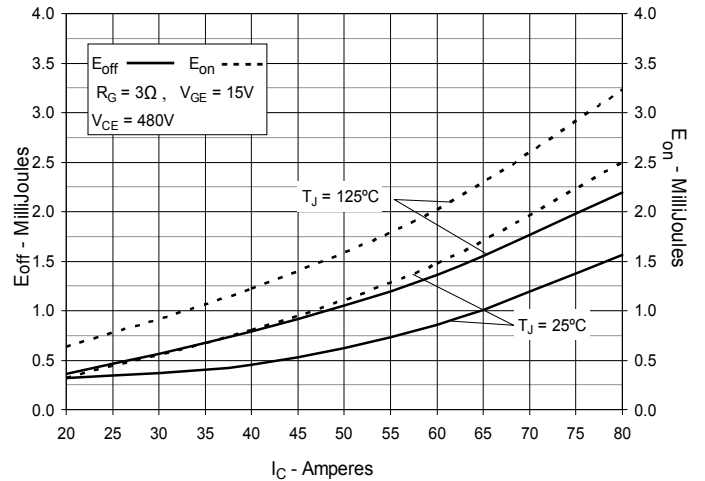

**Fig. 14. Inductive Switching Energy Loss vs. Junction Temperature**

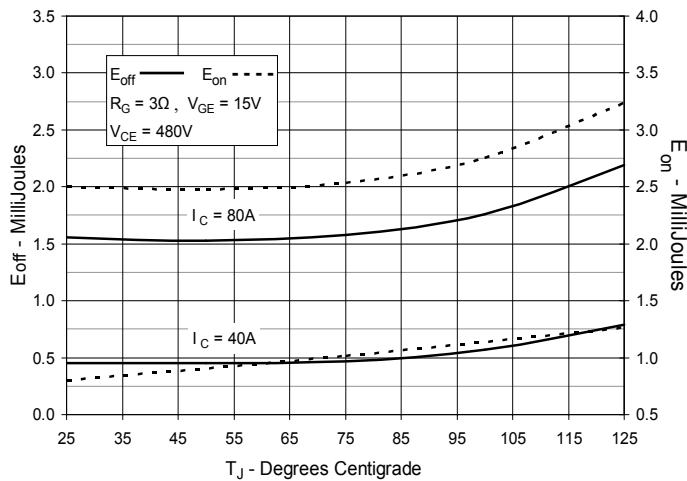

**Fig. 15. Inductive Turn-off Switching Times vs. Gate Resistance**

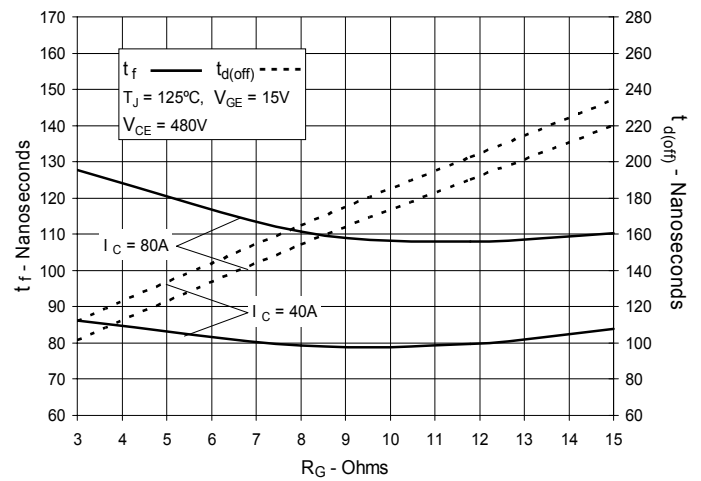

**Fig. 16. Inductive Turn-off Switching Times vs. Collector Current**

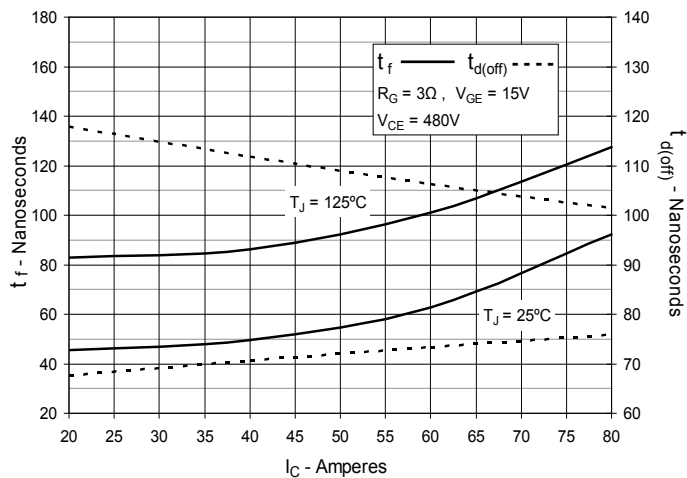

**Fig. 17. Inductive Turn-off Switching Times vs. Junction Temperature**

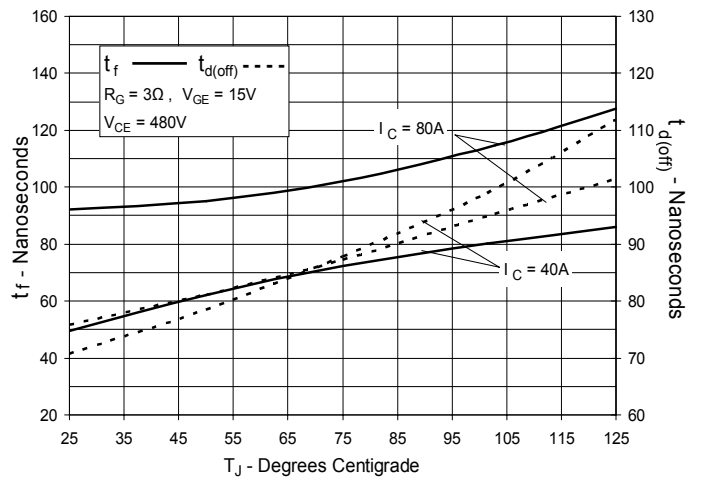

**Fig. 18. Inductive Turn-on Switching Times vs. Gate Resistance**

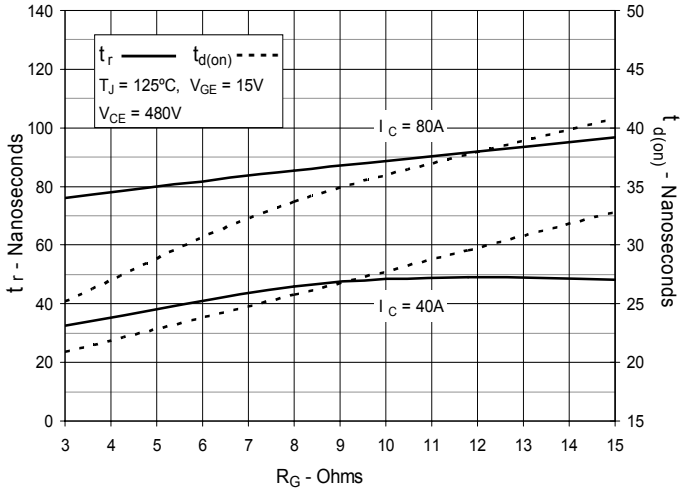

**Fig. 19. Inductive Turn-on Switching Times vs. Collector Current**

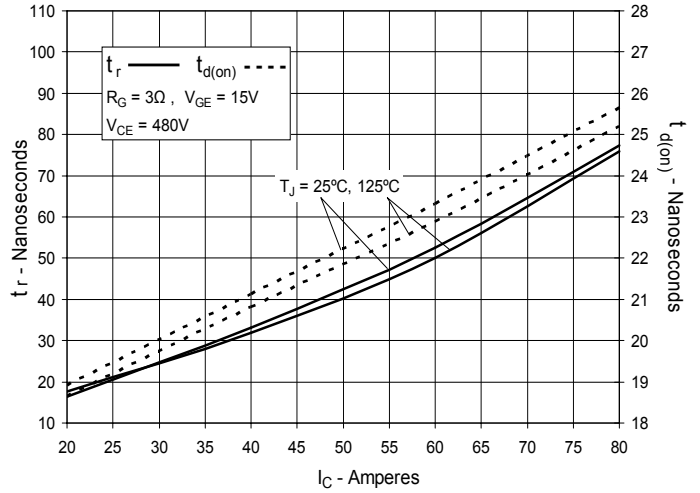

**Fig. 20. Inductive Turn-on Switching Times vs. Junction Temperature**

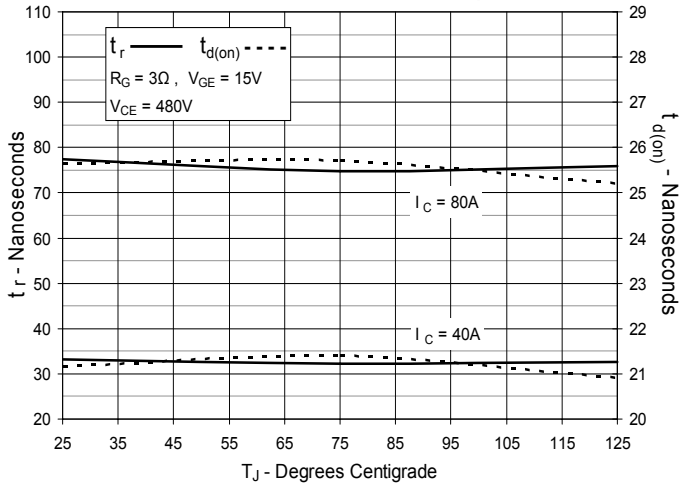

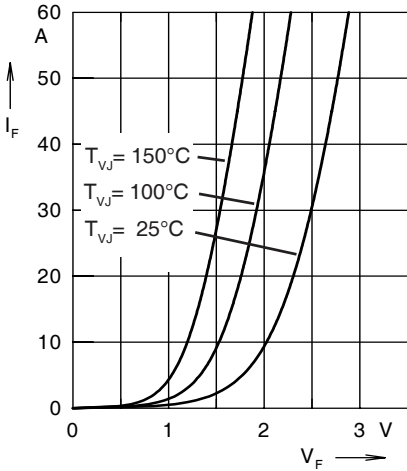

Fig. 21 Forward current  $I_F$  versus  $V_F$

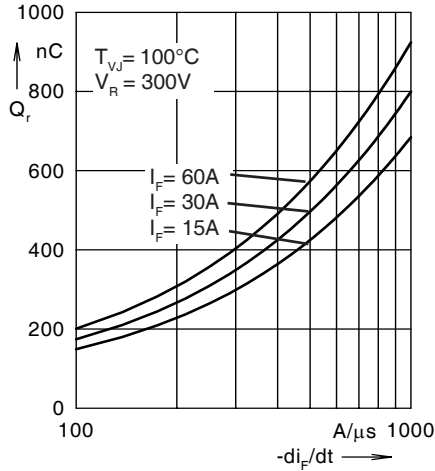

Fig. 22 Reverse recovery charge  $Q_r$  versus  $-di_F/dt$

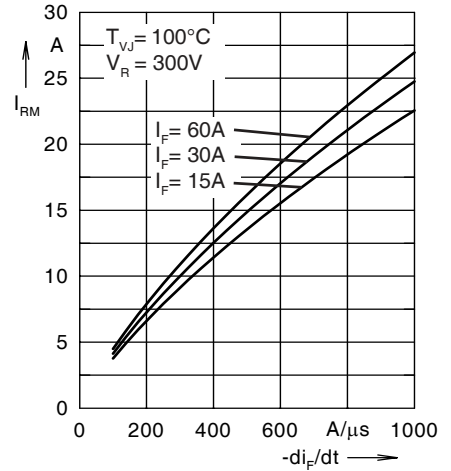

Fig. 23 Peak reverse current  $I_{RM}$  versus  $-di_F/dt$

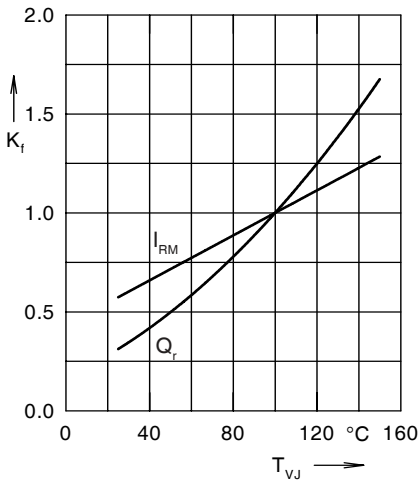

Fig. 24 Dynamic parameters  $Q_r$ ,  $I_{RM}$  versus  $T_{VJ}$

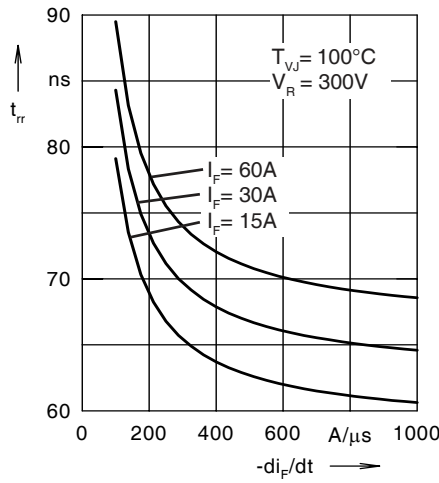

Fig. 25 Recovery time  $t_{rr}$  versus  $-di_F/dt$

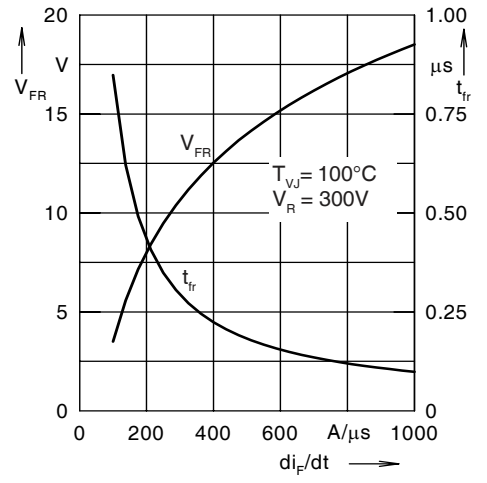

Fig. 26 Peak forward voltage  $V_{FR}$  and  $t_{fr}$  versus  $di_F/dt$

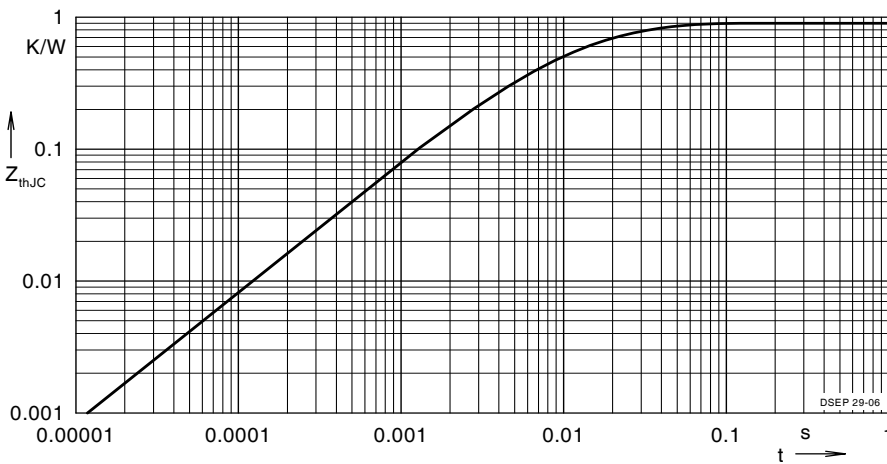

Fig. 27 Transient thermal resistance junction to case

Constants for  $Z_{thJC}$  calculation:

i	$R_{thi}$ (K/W)	$t_i$ (s)
1	0.502	0.0052
2	0.193	0.0003
3	0.205	0.0162



---

Disclaimer Notice - Information furnished is believed to be accurate and reliable. However, users should independently evaluate the suitability of and test each product selected for their own applications. Littelfuse products are not designed for, and may not be used in, all applications. Read complete Disclaimer Notice at [www.littelfuse.com/disclaimer-electronics](http://www.littelfuse.com/disclaimer-electronics).