

Lux Series G5 CLM-9 COB Arrays White LED



Features:

- High lumen output and efficacy typical
 - Over 1300 lm, 158LPW @ 3000K, 90CRI, $T_j = 85^\circ\text{C}$
- CCT range 2400K, 2700K, 3000K, 3500K, 4000K, 5000K and 6500K
- 3 SDCM and 2 SDCM color binning standard
- Excellent optical emission uniformity and color over angle consistency
- Superior thermal conductivity for uniform heat spreading
- Environmentally friendly: RoHS and REACH compliant



Applications

- Spotlights/Track Lights
- Downlights
- Shop Lighting
- Hospitality Lighting
- Architectural and Specialty
- Street Lighting
- Parking Lot and Area Lighting
- Tunnel Lighting

Contents

Part Number Nomenclature	2
CCT, CRI & R9 Specification	.2
Chromaticity Bin Structure	.3
Ordering Part Numbers	... 4
Operating Characteristics	..9
Optical and Electrical Characteristics 10
Typical Spectrum 12
Radiation Pattern 12
Mechanical Dimension	... 13
Shipping Container 13
Label Information 14
Technology Review 15
Test Specifications 15
Handling Notes 16



Part Number Nomenclature

All Luminus COB products are packaged and labeled with part numbers as outlined in the table on page 4. Luminus may include any smaller chromaticity bin that is contained in the larger bin as part of the ordered part. When shipped, each package will contain only a single flux and chromaticity bin. The part number designation is as follows:

CLM	—	9	—	NN	—	XX	—	VV	—	QQPP	—	FG	—	W
Product Family	LES ¹	CCT ²	Min. CRI ³	Typical Voltage	Package Configurator ⁴	Flux Bin	Chromaticity Bin							
Chip on Board, Multi-die	9mm LES diameter	See Note 2 below	CRI See Table Below	Volts (V)	TC50 TA50	Lumens	See page 3 for bins							

Notes:

1. Light Emitting Surface (LES) Diameter.
2. Correlated Color Temperature (CCT), NN nomenclature corresponds to the following:
 24 = 2400K
 27 = 2700K
 30 = 3000K
 35 = 3500K
 40 = 4000K
 50 = 5000K
 65 = 6500K
3. Minimum Color Rendering Index (CRI).
4. TC is a standard substrate with sulfur resistance process, TA is an alternative substrate; 5 means Lux G5 COB products, 0 means a product with chromaticity on the BBL.
5. Luminus part numbers may be accompanied by prefixes or suffixes. The most common is the "Rev01" suffix indicating a part is fully released and carries a full warranty. These additional characters may appear on shipping labels, packing slips and invoices. In all cases the basic part number described above will always be included.

CCT, CRI and R9 Values

Correlated Color Temperatures	XX Value	CRI	*R9
2400K, 2700K, 3000K, 3500K, 4000K, 5000K, 6500K	90	>90	>50
2700K, 3000K	95	>95	>85
3500K, 4000K, 5000K			>75

Note: R9 values have a tolerance of +/- 5%



Chromaticity Bin Structure

Chromaticity Bins: 1931 CIE Color Space

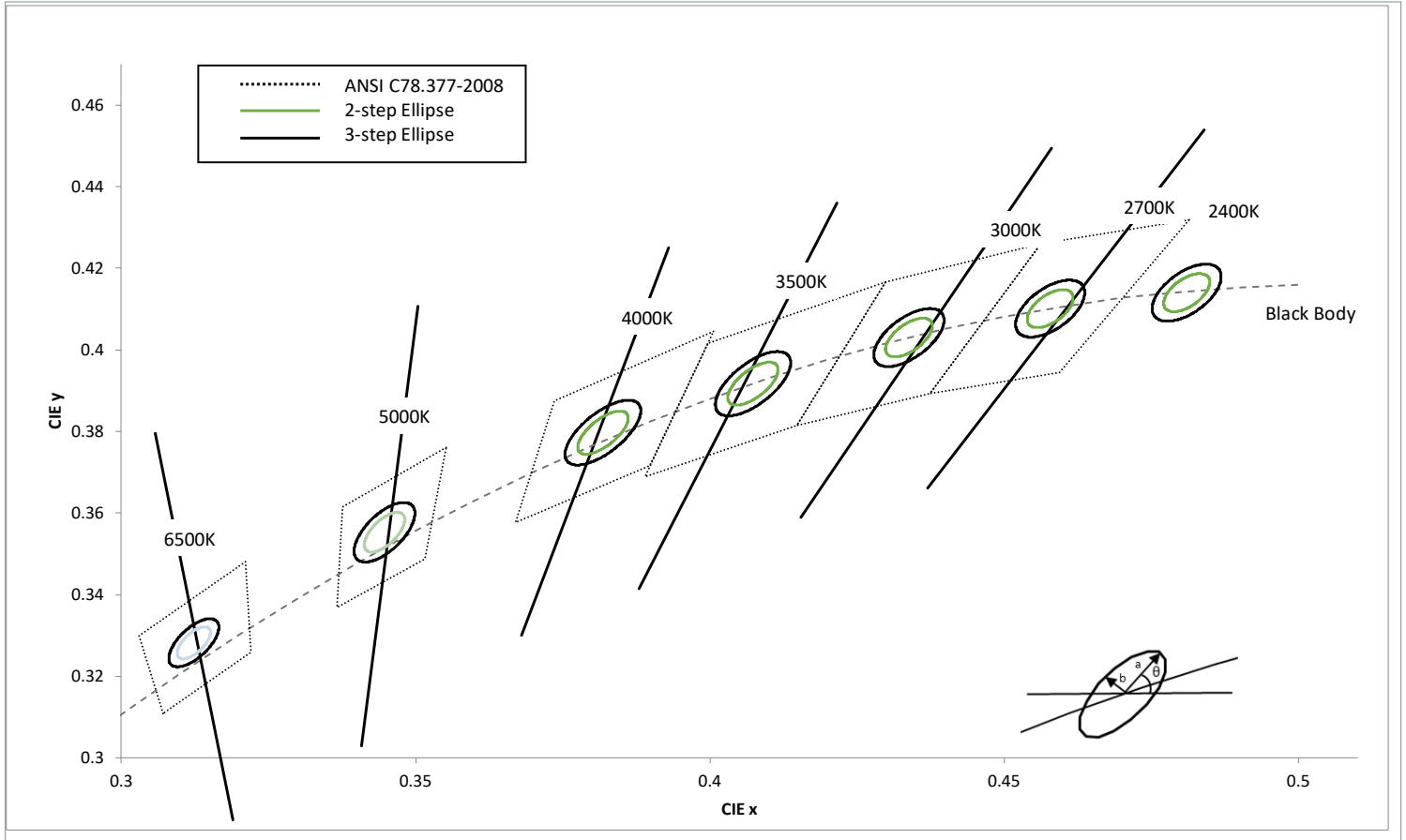

The following tables describe the chromaticity bin center points, the orientation angle for the MacAdam ellipse (θ°), and the maximum radii for the ellipses. The ANSI Bin is provided for reference.

CCT	Center Point		Angle θ°	3-step Bin		2-step Bin	
	CIE _x	CIE _y		a	b	a	b
2400K	0.4810	0.4140	53.7	0.0081	0.0042	0.0054	0.0028
2700K	0.4578	0.4101	53.7	0.0081	0.0042	0.0054	0.0028
3000K	0.4338	0.4030	53.2	0.0083	0.0041	0.0056	0.0027
3500K	0.4073	0.3917	54.0	0.0093	0.0041	0.0062	0.0028
4000K	0.3818	0.3797	53.7	0.0094	0.0040	0.0063	0.0027
5000K	0.3447	0.3553	59.6	0.0082	0.0035	0.0055	0.0023
6500K	0.3123	0.3282	58.6	0.0067	0.0029	0.0045	0.0019

Note: Luminus maintains a +/- 0.005 tolerance on chromaticity (CIE_x and CIE_y) measurements



Ordering Part Numbers (TC50)-36V

The following tables describe products with typical flux and minimum flux measured at 250mA and specified at $T_j = 85^\circ\text{C}$. The values at 25°C are calculated and shown for reference only.

CCT	Output Flux (lm)			Color Rendering Index (min.)	Ordering Part Number	
	Typ. (85°C)	Min. (85°C)	Calculated Typ. (25°C)		3-step MacAdam Ellipse	2-step MacAdam Ellipse
2400K	1195	1110	1315	90	CLM-9-24-90-36-TC50-F6-3	CLM-9-24-90-36-TC50-F6-2
2700K	1280	1190	1405	90	CLM-9-27-90-36-TC50-F6-3	CLM-9-27-90-36-TC50-F6-2
	1165	1085	1280	95	CLM-9-27-95-36-TC50-F6-3	CLM-9-27-95-36-TC50-F6-2
3000K	1300	1210	1430	90	CLM-9-30-90-36-TC50-F6-3	CLM-9-30-90-36-TC50-F6-2
	1210	1125	1330	95	CLM-9-30-95-36-TC50-F6-3	CLM-9-30-95-36-TC50-F6-2
3500K	1360	1265	1495	90	CLM-9-35-90-36-TC50-F6-3	CLM-9-35-90-36-TC50-F6-2
	1215	1130	1335	95	CLM-9-35-95-36-TC50-F6-3	CLM-9-35-95-36-TC50-F6-2
4000K	1360	1265	1495	90	CLM-9-40-90-36-TC50-F6-3	CLM-9-40-90-36-TC50-F6-2
	1265	1175	1390	95	CLM-9-40-95-36-TC50-F6-3	CLM-9-40-95-36-TC50-F6-2
5000K	1345	1250	1480	90	CLM-9-50-90-36-TC50-F6-3	CLM-9-50-90-36-TC50-F6-2
	1275	1185	1400	95	CLM-9-50-95-36-TC50-F6-3	CLM-9-50-95-36-TC50-F6-2
6500K	1325	1230	1455	90	CLM-9-65-90-36-TC50-F6-3	CLM-9-65-90-36-TC50-F6-2

*Note: Luminus maintains a +/- 6% tolerance on flux measurements.
Luminus maintains a +/- 2% tolerance on CRI measurements.*



Ordering Part Numbers (TC50)-18V

The following tables describe products with typical flux and minimum flux measured at 500mA and specified at $T_j = 85^\circ\text{C}$. The values at 25°C are calculated and shown for reference only.

CCT	Output Flux (lm)			Color Rendering Index (min.)	Ordering Part Number	
	Typ. (85°C)	Min. (85°C)	Calculated Typ. (25°C)		3-step MacAdam Ellipse	2-step MacAdam Ellipse
2400K	1195	1110	1315	90	CLM-9-24-90-18-TC50-F6-3	CLM-9-24-90-18-TC50-F6-2
2700K	1280	1190	1405	90	CLM-9-27-90-18-TC50-F6-3	CLM-9-27-90-18-TC50-F6-2
	1165	1085	1280	95	CLM-9-27-95-18-TC50-F6-3	CLM-9-27-95-18-TC50-F6-2
3000K	1300	1210	1430	90	CLM-9-30-90-18-TC50-F6-3	CLM-9-30-90-18-TC50-F6-2
	1210	1125	1330	95	CLM-9-30-95-18-TC50-F6-3	CLM-9-30-95-18-TC50-F6-2
3500K	1360	1265	1495	90	CLM-9-35-90-18-TC50-F6-3	CLM-9-35-90-18-TC50-F6-2
	1215	1130	1335	95	CLM-9-35-95-18-TC50-F6-3	CLM-9-35-95-18-TC50-F6-2
4000K	1360	1265	1495	90	CLM-9-40-90-18-TC50-F6-3	CLM-9-40-90-18-TC50-F6-2
	1265	1175	1390	95	CLM-9-40-95-18-TC50-F6-3	CLM-9-40-95-18-TC50-F6-2
5000K	1345	1250	1480	90	CLM-9-50-90-18-TC50-F6-3	CLM-9-50-90-18-TC50-F6-2
	1275	1185	1400	95	CLM-9-50-95-18-TC50-F6-3	CLM-9-50-95-18-TC50-F6-2
6500K	1325	1230	1455	90	CLM-9-65-90-18-TC50-F6-3	CLM-9-65-90-18-TC50-F6-2

*Note: Luminus maintains a +/- 6% tolerance on flux measurements.
Luminus maintains a +/- 2% tolerance on CRI measurements.*



Ordering Part Numbers (TA50)-36V

The following tables describe products with typical flux and minimum flux measured at 250mA and specified at $T_j = 85^\circ\text{C}$. The values at 25°C are calculated and shown for reference only.

CCT	Output Flux (lm)			Color Rendering Index (min.)	Ordering Part Number	
	Typ. (85°C)	Min. (85°C)	Calculated Typ. (25°C)		3-step MacAdam Ellipse	2-step MacAdam Ellipse
2400K	1195	1110	1315	90	CLM-9-24-90-36-TA50-F6-3	CLM-9-24-90-36-TA50-F6-2
2700K	1280	1190	1405	90	CLM-9-27-90-36-TA50-F6-3	CLM-9-27-90-36-TA50-F6-2
	1165	1085	1280	95	CLM-9-27-95-36-TA50-F6-3	CLM-9-27-95-36-TA50-F6-2
3000K	1300	1210	1430	90	CLM-9-30-90-36-TA50-F6-3	CLM-9-30-90-36-TA50-F6-2
	1210	1125	1330	95	CLM-9-30-95-36-TA50-F6-3	CLM-9-30-95-36-TA50-F6-2
3500K	1360	1265	1495	90	CLM-9-35-90-36-TA50-F6-3	CLM-9-35-90-36-TA50-F6-2
	1215	1130	1335	95	CLM-9-35-95-36-TA50-F6-3	CLM-9-35-95-36-TA50-F6-2
4000K	1360	1265	1495	90	CLM-9-40-90-36-TA50-F6-3	CLM-9-40-90-36-TA50-F6-2
	1265	1175	1390	95	CLM-9-40-95-36-TA50-F6-3	CLM-9-40-95-36-TA50-F6-2
5000K	1345	1250	1480	90	CLM-9-50-90-36-TA50-F6-3	CLM-9-50-90-36-TA50-F6-2
	1275	1185	1400	95	CLM-9-50-95-36-TA50-F6-3	CLM-9-50-95-36-TA50-F6-2
6500K	1325	1230	1455	90	CLM-9-65-90-36-TA50-F6-3	CLM-9-65-90-36-TA50-F6-2

*Note: Luminus maintains a +/- 6% tolerance on flux measurements.
Luminus maintains a +/- 2% tolerance on CRI measurements.*



Chromaticity Bin Structure
Chromaticity Bins: 1931 CIE Color Space

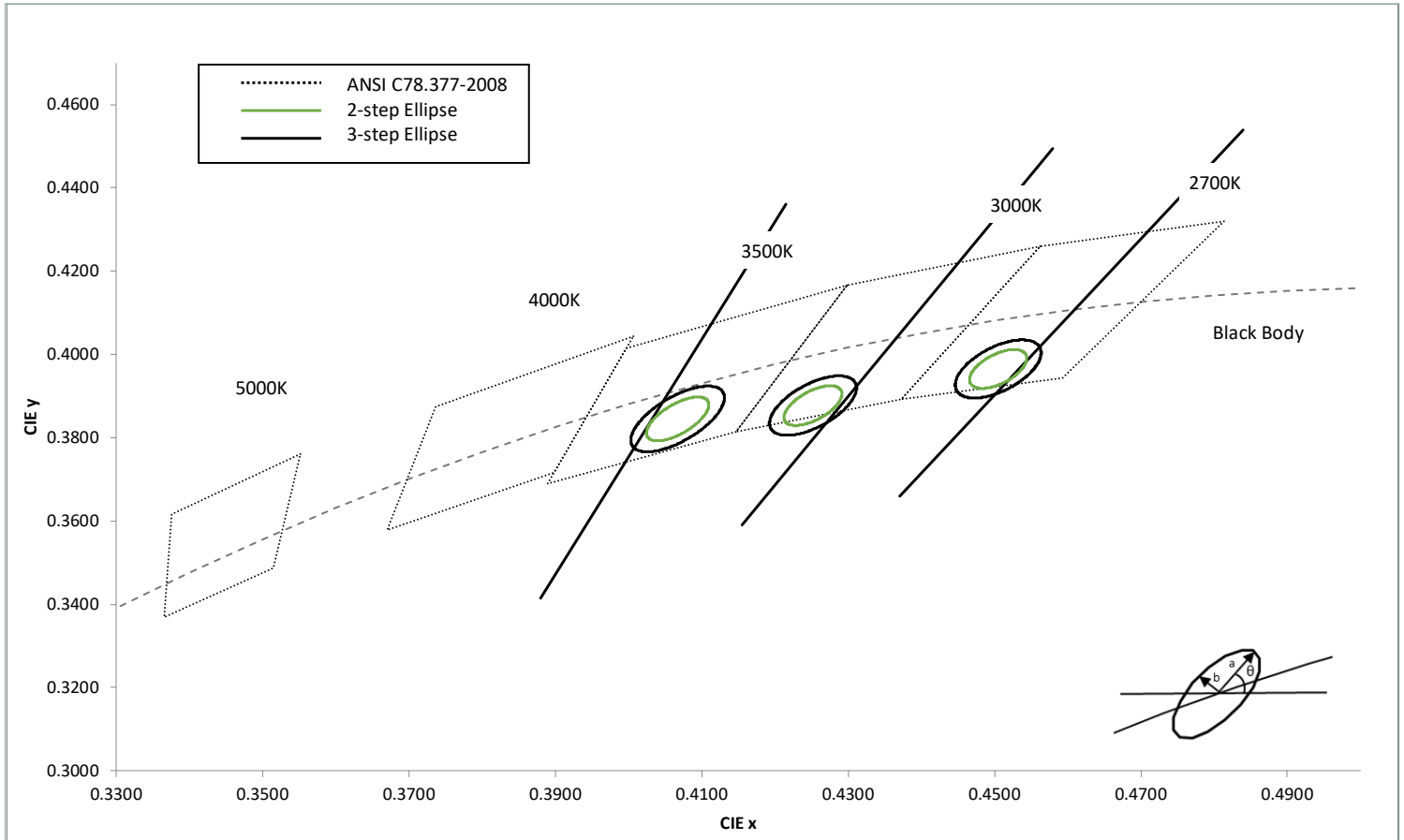

This table defines the chromaticity bin center points, the orientation angle for the MacAdam ellipse (θ°), and the maximum radii for the ellipses. The ANSI Bin is provided in the above graph for reference.

CCT	Center Point		Angle θ°	3-step Bin		2-step Bin	
	CIE _x	CIE _y		a	b	a	b
2700K	0.4505	0.3965	53.7	0.0081	0.0042	0.0054	0.0028
3000K	0.4252	0.3877	53.6	0.0083	0.0041	0.0056	0.0027
3500K	0.4067	0.3845	54.0	0.0093	0.0041	0.0062	0.0028

Note: Luminus maintains a +/- 0.005 tolerance on chromaticity (CIE_x and CIE_y) measurements



Ordering Part Numbers - TC/TA52 Sensus (BBBL)

The following tables describe products with typical flux and minimum flux measured at typical current and specified at $T_j = 85^\circ\text{C}$. The values at 25°C are calculated and shown for reference only.

CCT	Output Flux (lm)			Color Rendering Index (min.)	Typical Current (mA)	Ordering Part Number	
	Typ. (85°C)	Min. (85°C)	Calculated Typ. (25°C)			3-step MacAdam Ellipse	2-step MacAdam Ellipse
2700K	1235	1150	1365	90	250	CLM-9-27-90-36-TC52-F6-3	CLM-9-27-90-36-TC52-F6-2
					500	CLM-9-27-90-18-TC52-F6-3	CLM-9-27-90-18-TC52-F6-2
					250	CLM-9-27-90-36-TA52-F6-3	CLM-9-27-90-36-TA52-F6-2
3000K	1260	1175	1390	90	250	CLM-9-30-90-36-TC52-F6-3	CLM-9-30-90-36-TC52-F6-2
					500	CLM-9-30-90-18-TC52-F6-3	CLM-9-30-90-18-TC52-F6-2
					250	CLM-9-30-90-36-TA52-F6-3	CLM-9-30-90-36-TA52-F6-2
3500K	1295	1205	1420	90	250	CLM-9-35-90-36-TC52-F6-3	CLM-9-35-90-36-TC52-F6-2
					500	CLM-9-35-90-18-TC52-F6-3	CLM-9-35-90-18-TC52-F6-2
					250	CLM-9-35-90-36-TA52-F6-3	CLM-9-35-90-36-TA52-F6-2

*Note: Luminus maintains a +/- 6% tolerance on flux measurements.
Luminus maintains a +/- 2% tolerance on CRI measurements.*



Operating Characteristics¹

Parameter-18V	Symbol	Minimum	Typical	Maximum	Unit
Forward Current ²	I_f		500	880	mA
Forward Voltage ³	V_f	15.4	16.4	17.2	V

Parameter-36V	Symbol	Minimum	Typical	Maximum	Unit
Forward Current ²	I_f		250	440	mA
Forward Voltage ³	V_f	30.8	32.8	34.3	V
Power			8.2	15	W
Operating Case Temperature	T_c			105	°C
Light Emitting Surface Diameter	LES		9.8		mm
Thermal Resistance (junction-to-case)	Θ_{jc}		0.5		°C/W
Junction Temperature	T_j			140	°C
Viewing Angle			120		Degree

Notes:

1. Device measurements are at $T_j=85^\circ\text{C}$.
2. To prevent damage refer to operating conditions and derating curves for appropriate maximum operating conditions
3. Voltage is rated at typical forward current. For voltage at higher drive current, refer to performance graphs.
4. Thermal resistance is measured from LED junction-to- T_c (thermal contact point), at typical current using JESD51-14.
5. Device operation not recommended at drive currents less than 10% of the typical value
6. Caution must be taken not to stare at the light emitted from these LEDs. Under special circumstances, the high intensity could damage the eye.



Optical & Electrical Characteristics (36V)

Relative Output Flux vs. Forward Current @ 85°C

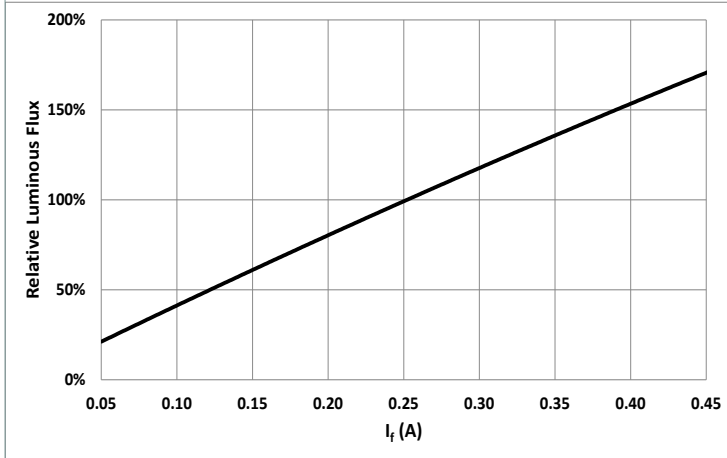

Forward Current vs. Forward Voltage @ 85°C

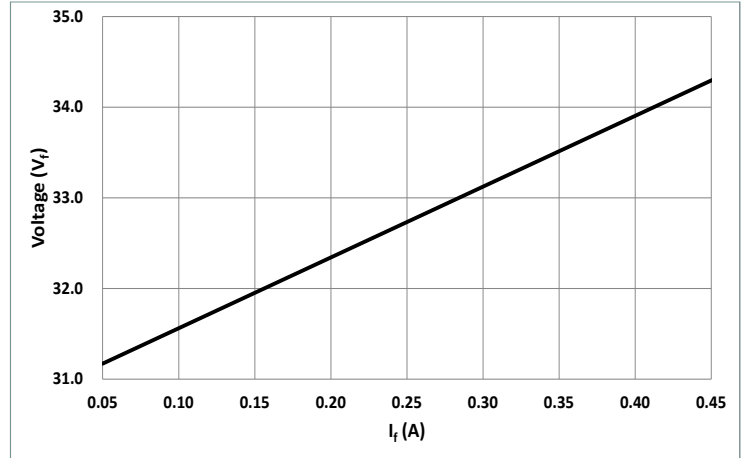

Relative Output Flux vs. Junction Temperature

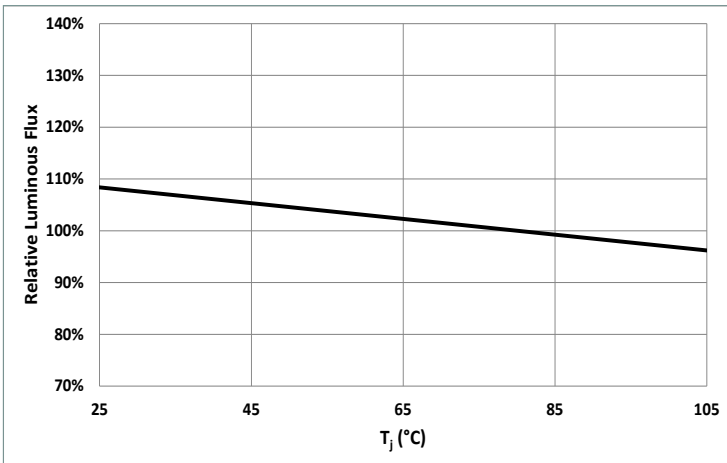

Change in Voltage vs. Junction Temperature

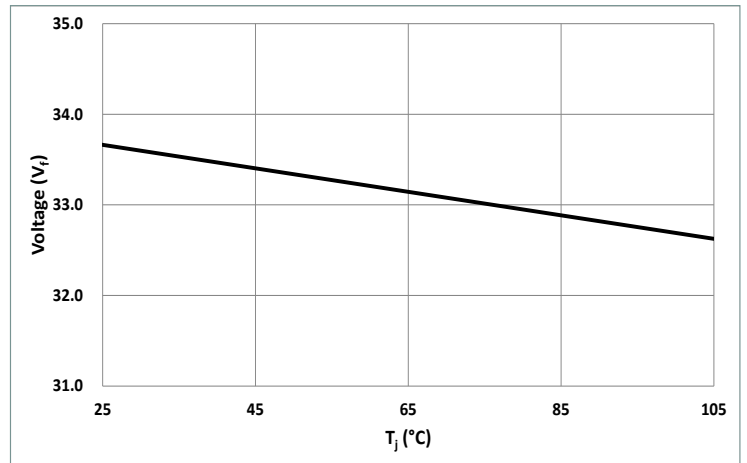

Change in CIE_x/y vs. Junction Temp. (3000K, 90CRI)

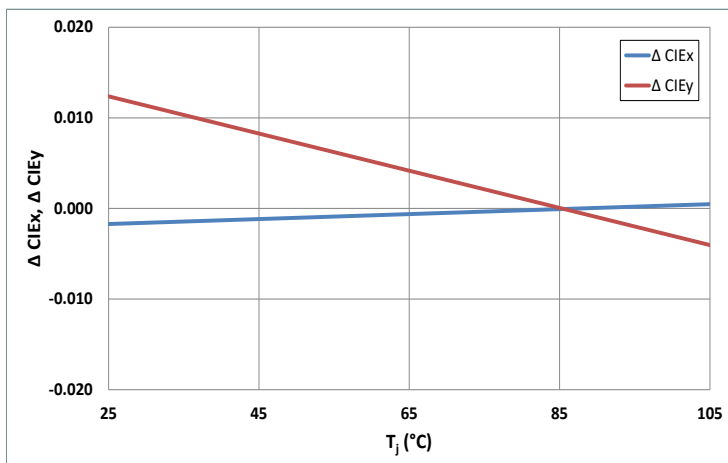

Change in CIE_x/y vs. Forward Current (3000K, 90CRI)

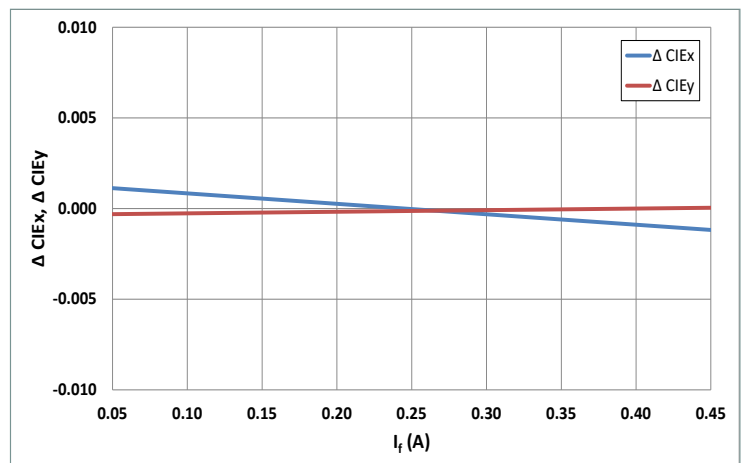



Optical & Electrical Characteristics (18V)

Relative Output Flux vs. Forward Current @ 85°C

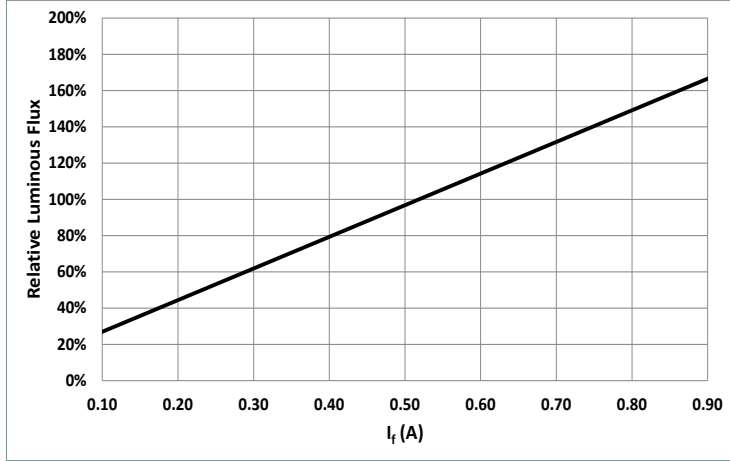

Forward Current vs. Forward Voltage @ 85°C

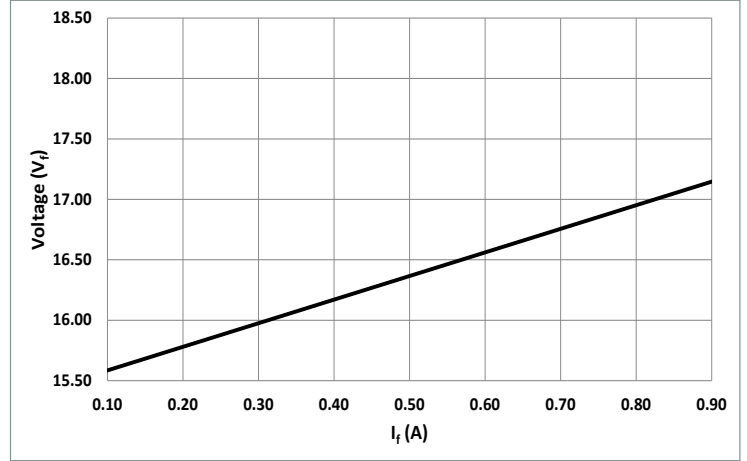

Relative Output Flux vs. Junction Temperature

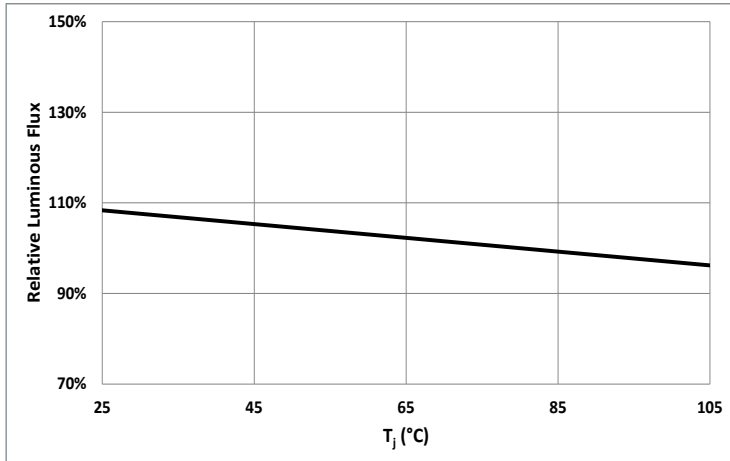

Change in Voltage vs. Junction Temperature

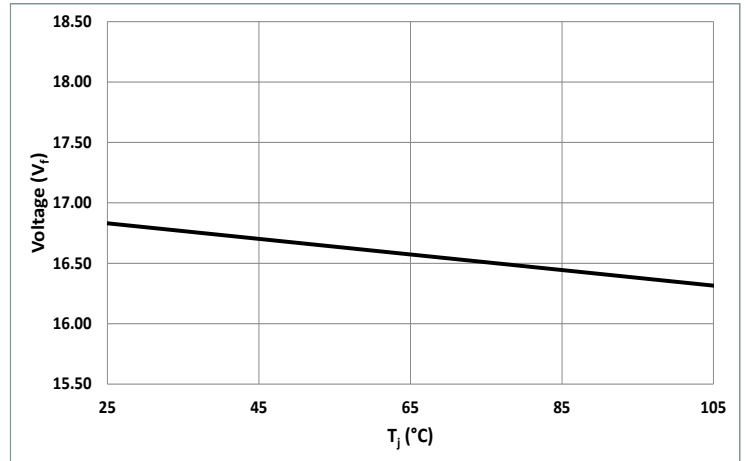

Change in CIE_x/y vs. Junction Temp. (3000K, 90CRI)

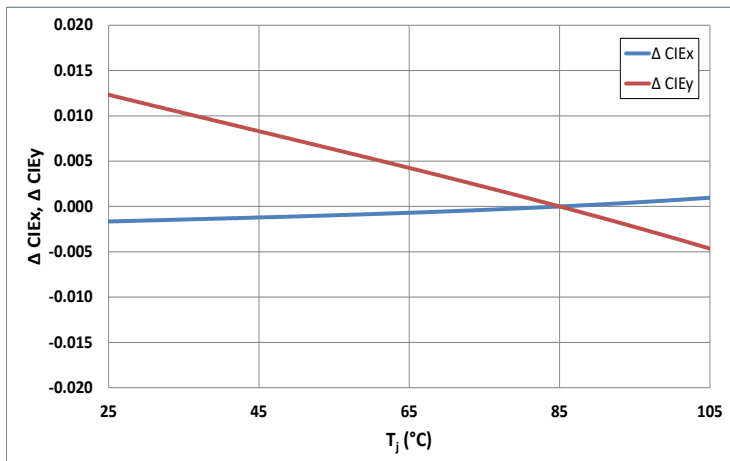

Change in CIE_x/y vs. Forward Current (3000K, 90CRI)

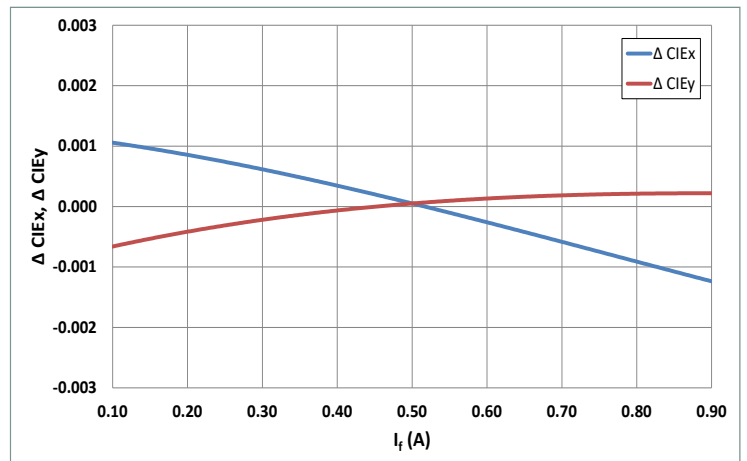



Typical Spectrum

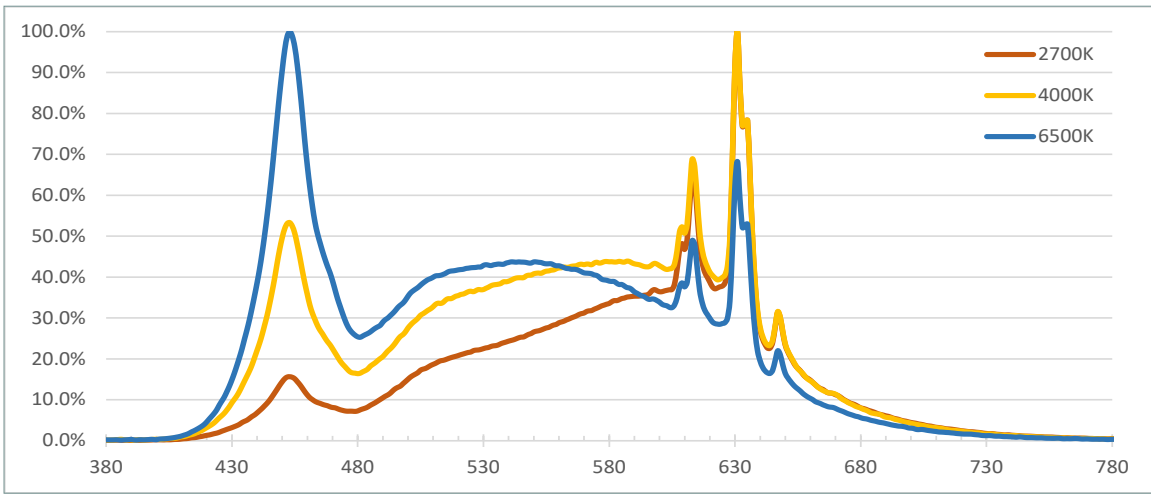

Radiation Pattern

Typical Polar Radiation Pattern

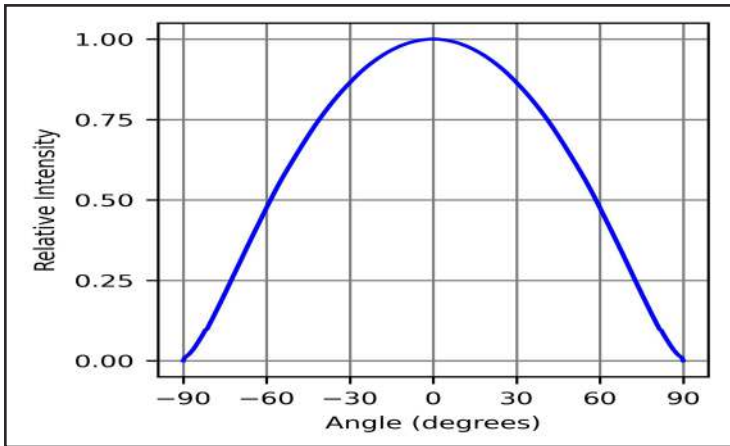

Typical Angular Radiation Pattern

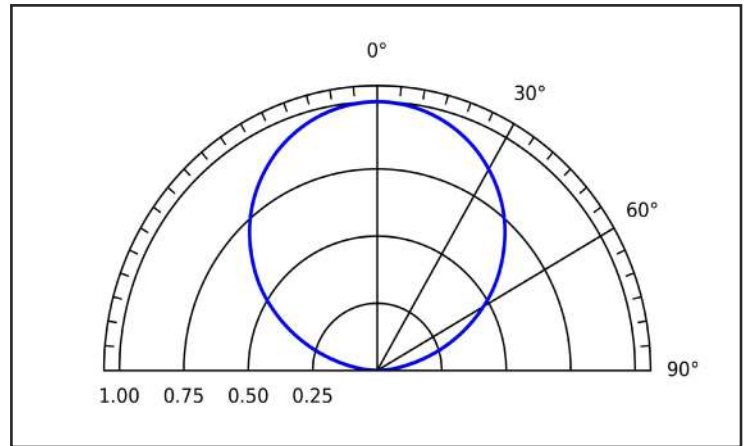



Mechanical Dimensions (TC50)

Note: Unless otherwise specified, tolerance is $\pm 0.3\text{mm}$

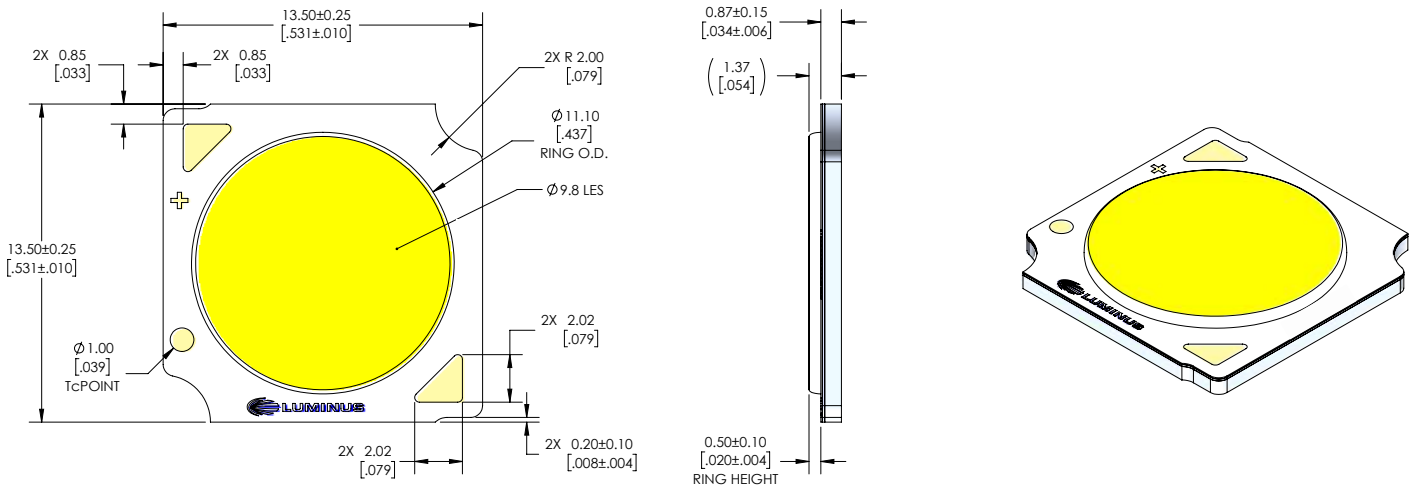

Shipping Container



Package model -- for illumination

Note: 80 pcs per tray and 5 trays are stacked together to be sealed in an anti-static bag.



Note: The anti-static bag is boxed for easier storage, 400pcs per box.



Mechanical Dimensions (TA50)

Note: Unless otherwise specified, tolerance is $\pm 0.3\text{mm}$

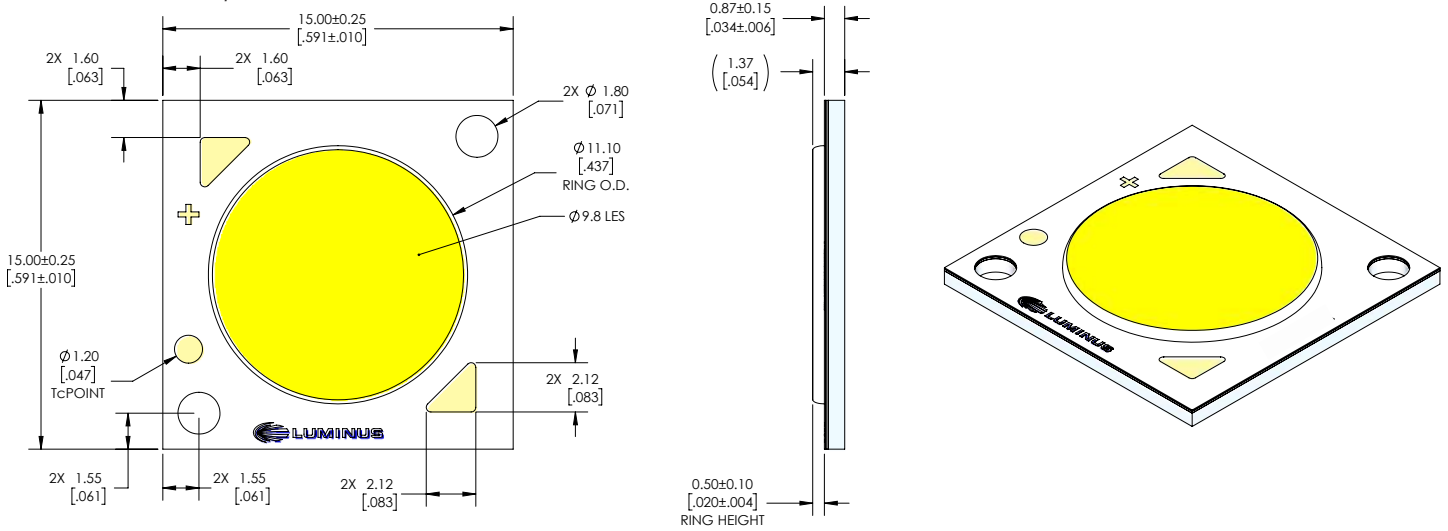

Shipping Container



Package model -- for illumination

Note: 60 pcs per tray and 5 trays are stacked together to be sealed in an anti-static bag.



Note: The anti-static bag is boxed for easier storage, 300pcs per box.

Label Information

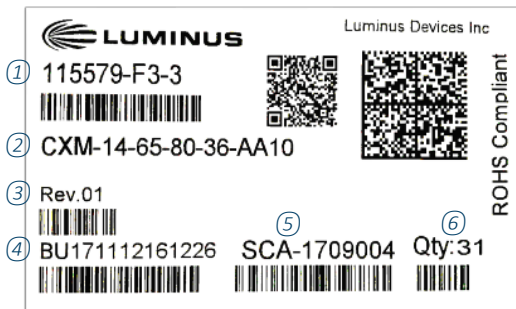

Label model -- for illustration only

Notes:

- ① Manufacturer part number, flux bin and chromaticity bin
- ② Customer part number
- ③ Rev.01 indicates a fully released product
- ④ Box ID
- ⑤ Production ID
- ⑥ Total number of units in a box



Technology Overview

Luminus Chip-on-Board (COB) LED series have consistently delivered the highest lumen performance with the best color quality of any COB supplier. Driving performance enhancements through more than 5 generations of COB products has provided Luminus a comprehensive understanding of the lighting market for directional sources positioning Luminus as the COB manufacturer of choice for the most discriminating lighting manufacturers.

Reliability

Designed from the ground up, the Luminus COB LED is one of the most reliable light sources in the world today.

UL and IEC Recognized Compliance

Luminus COB arrays are tested in accordance with ANSI/UL 8750 to ensure safe operation for their intended applications. Further, Luminus maintains IEC-62031 safety ratings on all COB products.

REACH & RoHS Compliance

All LED products manufactured by Luminus are REACH and RoHS compliant and free of hazardous materials, including lead and mercury.

Test Specifications

Every Luminus LED is fully tested to ensure it meets the high quality standards customers have come to expect from Luminus' products.

Traceability

Each Luminus COB LED is marked with a 2D bar code that contains a unique serial number. With this serial number, Luminus has the ability to provide customers with actual test data measurements for a specific LED. In addition, the 2D bar code is linked to manufacturing date codes that enables traceability of production processes and materials.

Testing Temperature

Luminus COB products are measured at temperatures typical for the LED operating in the fixture. Each device is tested at 85°C junction temperature eliminating the need to scale data sheet specifications to real world situations.

Chromaticity Bin Range

Chromaticity binning delivers color consistency for every order. Standard products are delivered with a 3-step MacAdam ellipse. This ensures color performance matching in the application. For the most demanding application, Luminus is one of only a few companies that can provide a 2 SDCM bin distribution. These tightly controlled, small distribution bins provide customers predictable, repeatable colors.



Handling Notes

Luminus products are designed for robust performance in general lighting application. However, care must be taken when handling and assembling the LEDs into their fixtures. To avoid damaging Luminus COBs please follow these guidelines.

The following is an overview of the application notes detailing some of the practices to follow when working with these devices. More detailed information is available on the Luminus web site at www.luminus.com.

General Handling

Devices are made to be lifted or carried with tweezers on two adjacent corners opposite the contact pads. At no time should the devices be handled by or should anything come in contact with the light emitting surface (LES) area. This area includes the yellow colored circular area and the ring surrounding it. There are electrical connections under the LES which if damaged will cause the device to fail. In addition, the ring frame itself should not be used for moving, lifting or carrying the device. Also do not attach any optics or mechanical holders to the ring as it is not capable to handle the mechanical stress.

Storage Condition

Please follow the conditions below.

Before opened	Temperature 5~30°C, relative humidity less than 60%.
After opened	Temperature 5~30°C, relative humidity less than 60%. After opening, LED should be kept in an aluminum moisture proof bag with a moisture absorbent material
Avoid Corrosive gas	Avoid exposing to air with corrosive gas. If exposed, electrode surface would be damaged, which may affect soldering. More detailed information is available on the Luminus Applications Resources web pages.

Static Electricity

Luminus COBs are electronic devices which can be damaged by electrostatic discharge (ESD). Please use appropriate measures to assure the devices do not experience ESD during their handling and or storage. ESD protection guidelines should be used at all time when working with Luminus COBs.

Storage	Luminus products are delivered in ESD shielded bags and should be stored in these bags until used
Transporting	When transporting the devices from one assembly area to another, ESD shielded carts and carriers should be used
Assembly	Individuals handling Luminus COBs during assembly should be trained in ESD protection practices. Assemblers should maintain constant conductive contact with a path to ground by means of a wrist strap, ankle straps, mat or other ESD protection system



Chemical Compatibility

The resin material used to form the LES can get hydrocarbons from the surrounding environment. As a result, certain chemical compounds (H₂SO₄, H₂S, SO₂, NH₃, H₃PO₄, etc.) are not recommended for use with the Luminus products. Use of these compounds can cause damage to the light output of the device and may permanently damage the device. Please refer to the table below for a list of the compounds not recommended for use with the Luminus COB products.

Common Chemicals Know to Adversely Affect Luminus Devices		
Acetates	Ethers	Potassium hydroxide
Acetic acid	Cl, F or Br containing compounds	Siloxanes
Acrylates	Liquid hydrocarbons	Sodium Hydroxide
Aldehydes	Hydrochloric Acid	Sulfur compounds
Aldehydes	Ketones	Sulfuric Acid
Amines	Nitric Acid	Toluene
Benzene	Phosphoric acid	Xylenes
Dienes		

Thermal Interface Material (TIM)

Proper thermal management is critical for successful operation of any LED system. Excess operating temperature can reduce the light output of the device. Excessive heating can cause permanent damage to the device. Proper TIM material is a crucial component for effective heat transfer away from the LED during normal operation. Please refer to www.luminus.com for specific recommendations for TIM solutions.

Please refer to <https://www.luminus.com/resource/application-notes> for more application note information.