

Specification

Patent Pending

- Part No. : **FXUWB01.07.0100C**
- Description : AccuraUWB Flex Series 6~8GHz Ultra-Wide Band (UWB) Flex Antenna with 100mm 1.37 IPEX MHFHT
- Features : Embedded Flexible UWB Antenna
Omni-Directional
For European and USA UWB Applications
For Channels 5-7
Frequency: 6.0 - 8GHz
Cable: 100 mm 1.37 Coaxial
Connector: IPEX MHFHT (U.FL compatible)
Dims: 17.9mm x 15.5mm x 0.24mm
RoHS Compliant



1. Introduction

The AccuraUWB FXUWB01 flexible polymer antenna, at 17.9*15.5*0.24 mm, is a small form factor, ultra-thin Ultra-Wideband (UWB) antenna with high efficiencies across the pulsed UWB communications operational bands. It is assembled by a simple “peel and stick” process, attaching securely to non-metal surfaces via 3M adhesive. It enables designers to use only one antenna that covers all common UWB commercial bands, namely bands, 5, 6 and 7 simultaneously.

The AccuraUWB FXUWB01 antenna is a durable flexible polymer antenna that has a peak gain of 5dBi, an efficiency of more than 70% across the bands and is designed to be mounted directly onto a plastic or glass cover. It is an ideal choice for any device maker that needs to keep manufacturing costs down over the lifetime of a product. It is ground plane independent and delivered with a cable and connector for easy connecting to the wireless module or customer PCB. Cables and Connectors are customizable. Like all such antennas, care should be taken to mount the antenna at least 10mm from metal components or surfaces, and ideally 20mm for best Radiation efficiency.

Like all such antennas, care should be taken to mount the antenna at least 10mm from metal components or surfaces, and ideally 20mm for best radiation efficiency.

Ultra-wideband (also known as UWB) is a low power digital wireless technology for transmitting large amounts of digital data over a wide spectrum of frequency bands typically spanning more than 500MHz with very low power for short distances.

While the cable type and length are customizable, as is the connector, do note that a custom designed antenna may be needed in those circumstances. Also tuning of the antenna may be needed in specific customer device environments. Taoglas offers this testing and tuning service subject to NRE and MOQ. Contact your regional Taoglas office for support.

The low power requirements of UWB mean increased battery life of sensors and tags leading to reduction in overall operational costs. Taoglas has developed various innovative and new-to-market flexible embedded UWB antennas designed for seamless integration on plastics and using highly flexible micro-coaxial cable mounting while achieving high performance where space is limited. Taoglas UWB antennas have been designed for use with the recently launched Decawave ScenSor DW1000 module and are also compatible with any other UWB sensor modules on the market.

1.1. Applications of Pulsed UWB antenna Technology

Radar - These short-pulsed antennas provide very fine range resolution and precision distance and positioning measurement capabilities. UWB signals enable inexpensive high definition radar antennas which find use in automotive sensors, smart airbags, and precision surveying applications among many others.

Home Network Connectivity - Smart home and entertainment systems can take advantage of high data rates for streaming high quality audio and video contents in real time for consumer electronics and computing within a home environment.

Position Location & Tracking - UWB antennas also find use in Position Location and Tracking applications such as locating patients in case of critical condition, hikers injured in remote areas, tracking cars, and managing a variety of goods in large shopping malls. UWB offers better noise immunity and better accuracy to within a few cm compared to current localization technologies such as Assisted GPS for Indoors, Wi-Fi and cellular which are at best able to offer meter level precision. Tethered Indoor positioning UWB systems that measure the angles of arrival of ultra-wideband (UWB) radio signals perform triangulation by using multiple sensors to communicate with a tag device.

2. Specification

ELECTRICAL			
STANDARD	EU UWB		
	USA UWB channel 5	USA UWB channel 6	USA UWB channel 7
Operation Frequency (GHz)	6.24-6.74	6.74-7.24	5.95-7.03
Return Loss (dB)	-10	-10	-6
Efficiency (%)	82	72	70
Peak Gain (dBi)	3.5	4.5	4
Max VSWR	2:1	2:1	3:1
Radiation Properties	Omnidirectional		
Polarization	Linear		
Impedance	50Ω		
Max input Power	10W		
MECHANICAL			
Dimension	17.9mm x 15.5mm x 0.24mm		
Material	Flexible Polymer		
Connector and cable	IPEX and 1.37mm		
ENVIRONMENTAL			
Operation Temperature	-40°C to 85°C		
Storage Temperature	-40°C to 85°C		
Humidity	40% to 90%		

* Results obtained for antenna adhered to 2 mm thick ABS sheet.

3. Antenna Characteristics

3.1. Return Loss

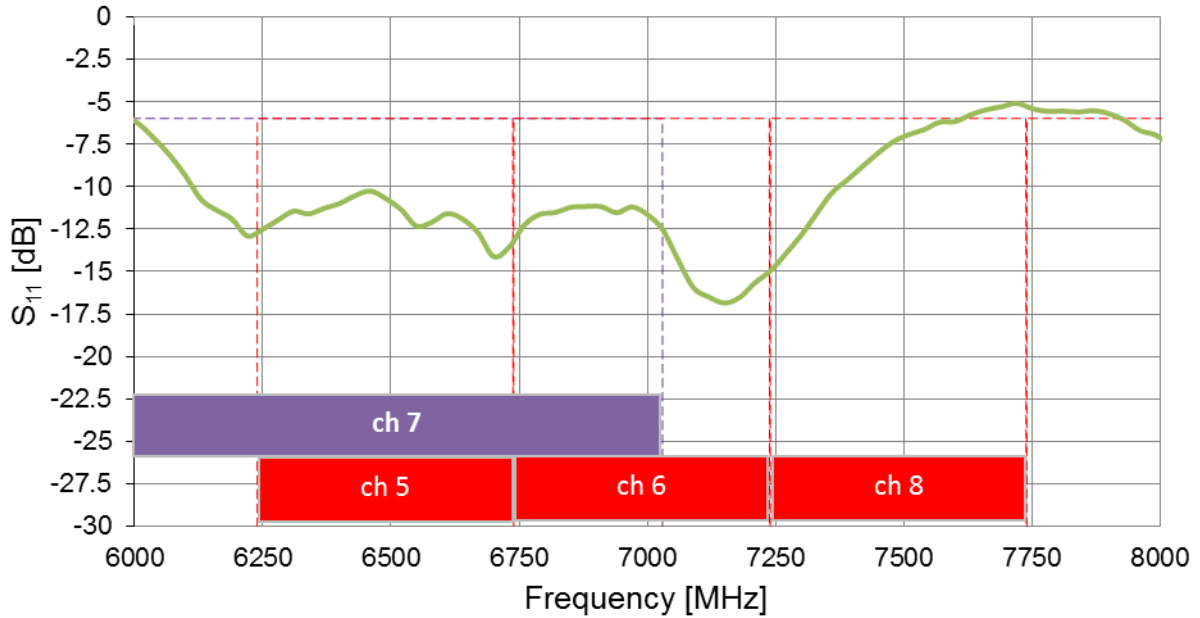

3.2. VSWR

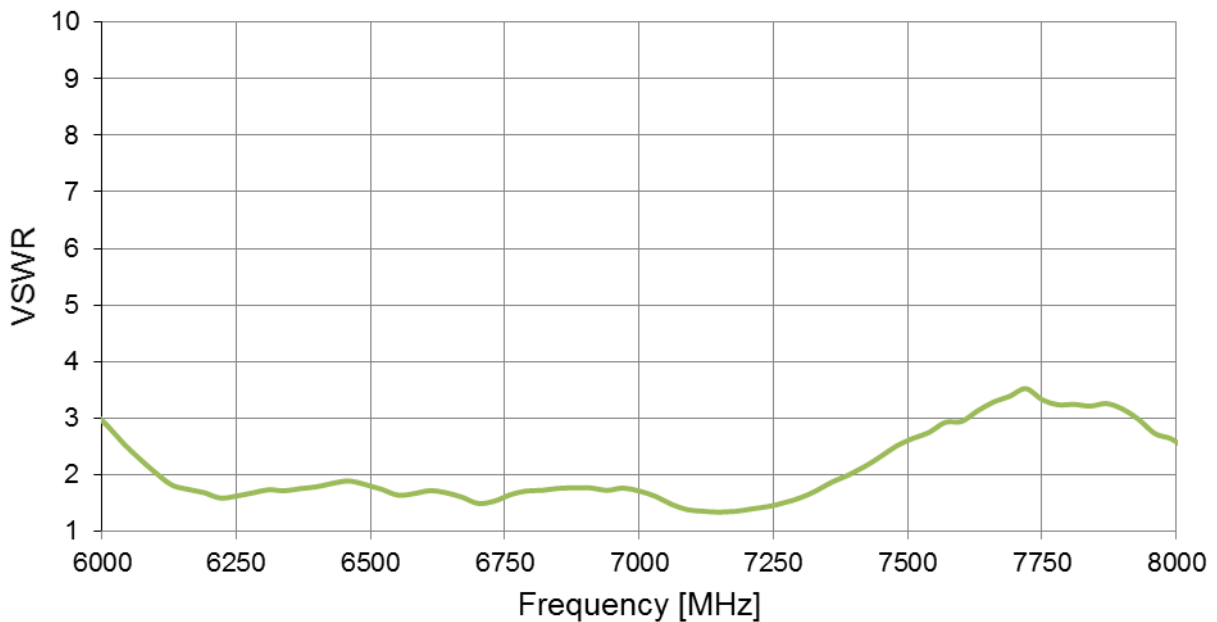

3.3. Efficiency

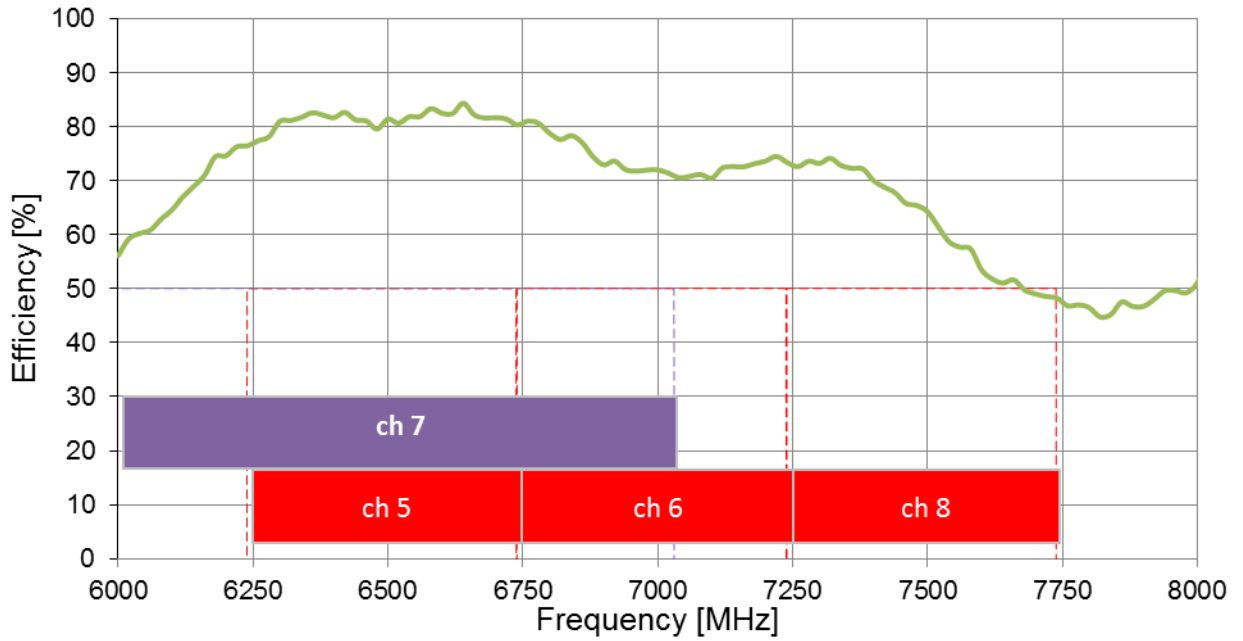

3.4. Peak Gain

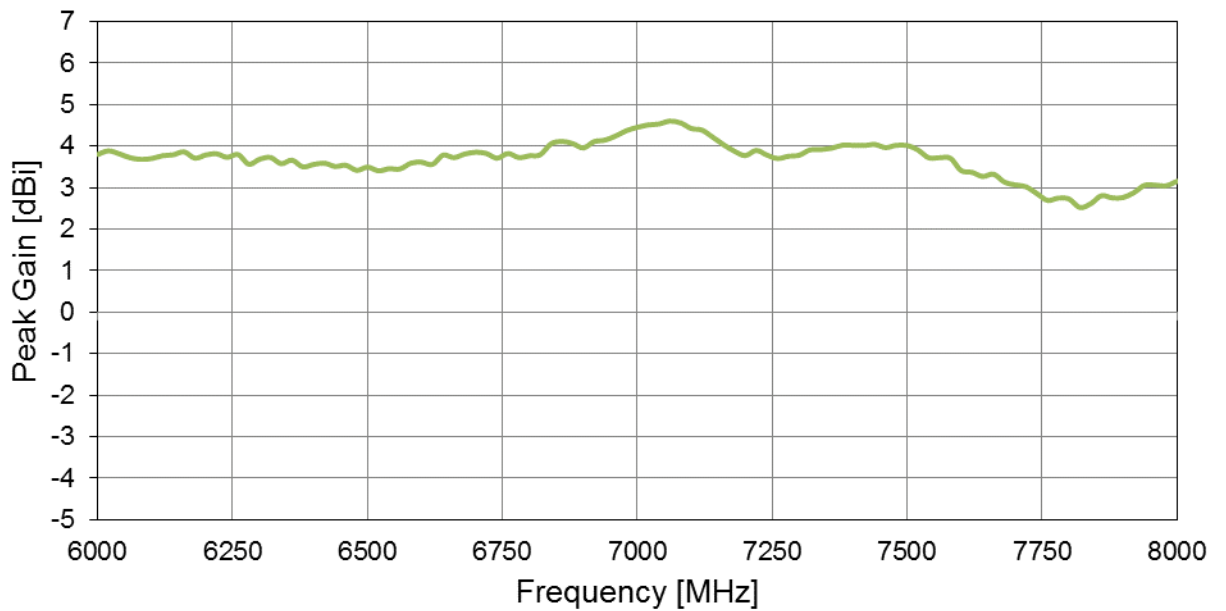

3.5. Average Gain

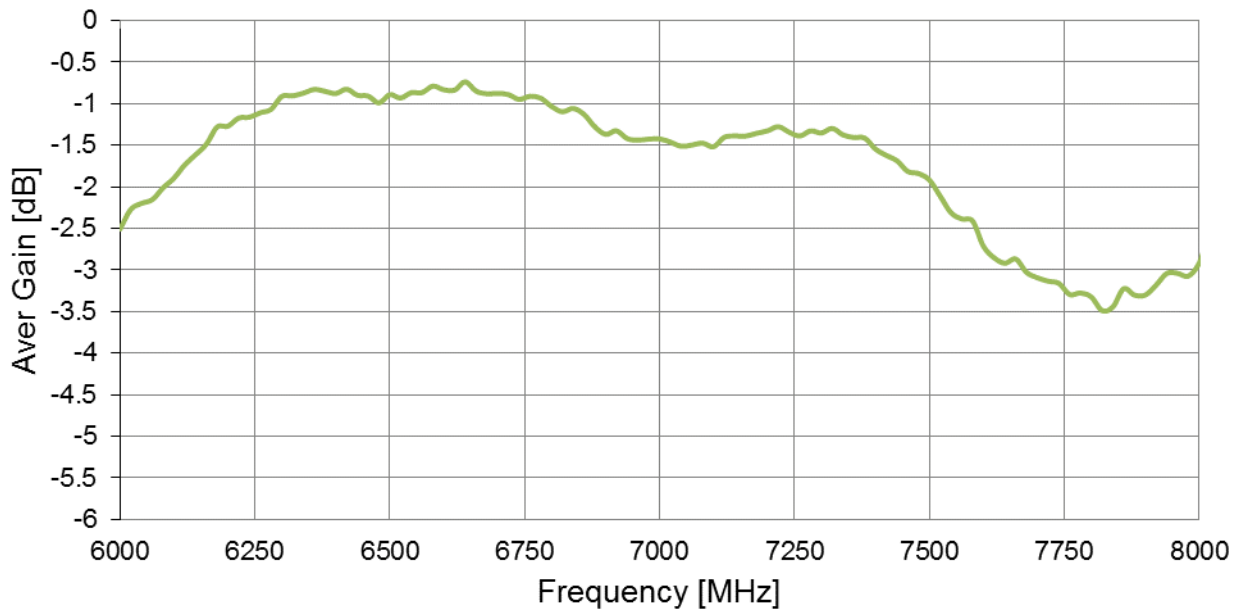

3.6. Group Delay (XY Plane) at 6.5GHz

The Total System Group Delay (in seconds) is the total time delay or transmit time of the amplitude envelopes of the various sinusoidal components of UWB signals through a device or link budget system. Effectively it is the propagation delay in transmitting antenna (Tx), propagation channel (Ch), and in receiving antenna (Rx) summed together.

An even more important parameter is the Group Delay Variation from an average constant group delay. The group delay ripple is used to quantify this deviation. Ultimately, deviations from a maximally flat or constant group delay represent distortions in the output signal which is undesirable. A group delay variation of 100-150ps or less is considered acceptable for UWB system implementation.

3.6.1. Group Delay Vs Frequency

The group delay was measured using ZVA24 Group Delay function at 6.5 GHz for two FXUWB01 antennas placed at a far-field distance of 1m distance. One of the antennas was kept stationary, while the other was rotated in 90° intervals.

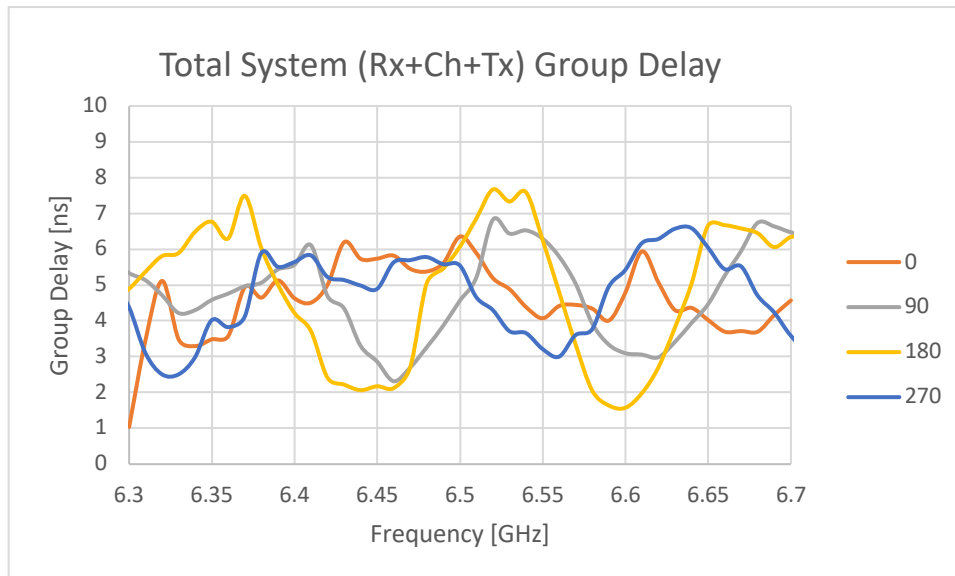

3.6.2. Group Delay Vs Theta

The values presented in the following graph for Group Delay vs Theta (azimuthal rotational angle) are obtained as average group delay values in the 6.3 GHz to 6.7 GHz interval as the instantaneous values at 6.5 GHz are under influence of ripple. This is equivalent to using Smoothing function on the ZVA24.

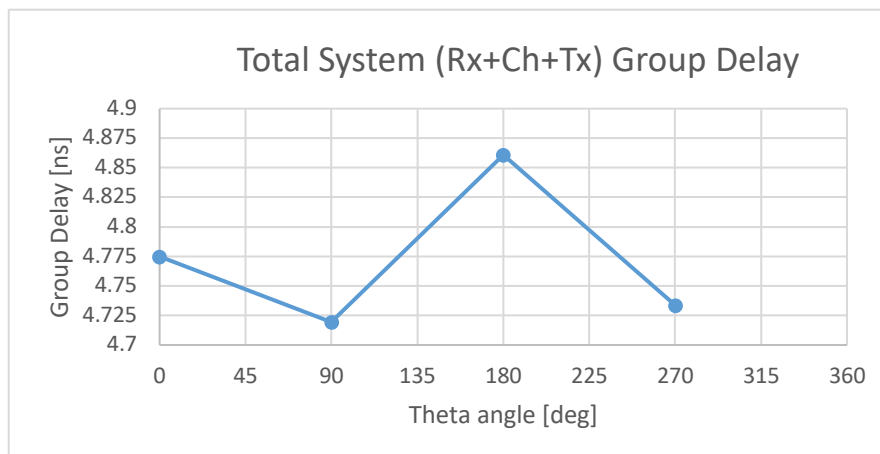

The measured Group Delay variation for the FXUBW01 antenna is 141ps as can be seen in the graph above Figure.

3.6.3. Fidelity (XY Plane) at 6.5 GHz

The impulse fidelity parameter is a measure of correlation between two impulses in the time domain $r(t)$ and $f(t)$, most commonly the input and the output one of the antenna system under study. Unlike other antenna parameters, impulse fidelity combines the antenna characterization in time, space and frequency in one parameter.

The pulse fidelity is defined in as:

$$F = \max_{\tau} \int_{-\infty}^{\infty} \frac{f(t)}{\left[\int_{-\infty}^{\infty} |f(t)|^2 dt \right]^{1/2}} \cdot \frac{r(t+\tau)}{\left[\int_{-\infty}^{\infty} |r(t)|^2 dt \right]^{1/2}} dt$$

The maximum fidelity, therefore minimum distortion between the two signals, is obtained for τ such that the integral term is maximized, which is simply the cross-correlation of the two normalized signals $f(t)$ and $r(t)$. The maximum fidelity, in this case, is equal to 1 or 100%. The desired impulse fidelity for UWB antennas is over 0.9 or 90% as stipulated in the FCC Part 15 of the Commission's Rules Regarding Ultra-Wideband Transmission Systems (FCC 02-48).

Below is an example of the input signal and signal received in one particular direction from the antenna.

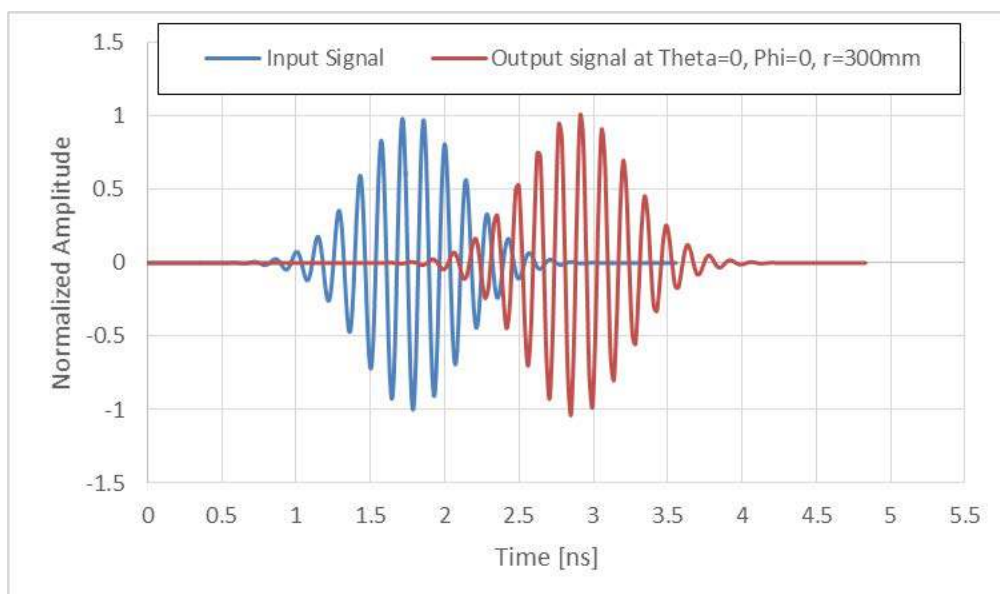

Fidelity of signals as above is calculated and results as below are obtained. The values are well above 0.9 and it is considered that antenna has very good performance.

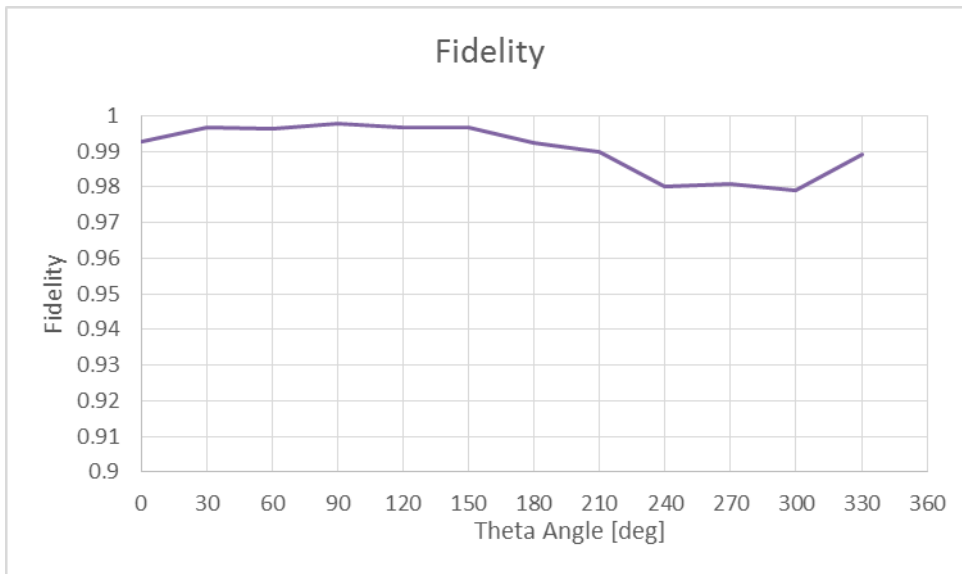

4. Antenna Radiation Pattern

4.1. Measurement Setup

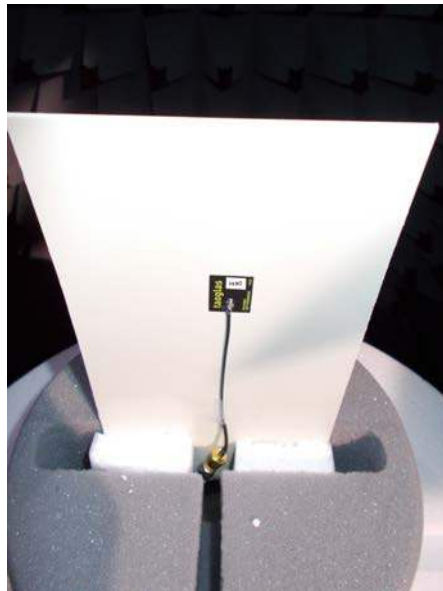
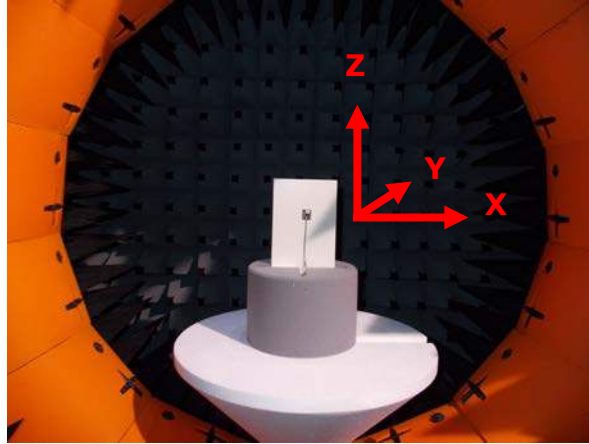

4.2. 2D Radiation Pattern

XZ Plane

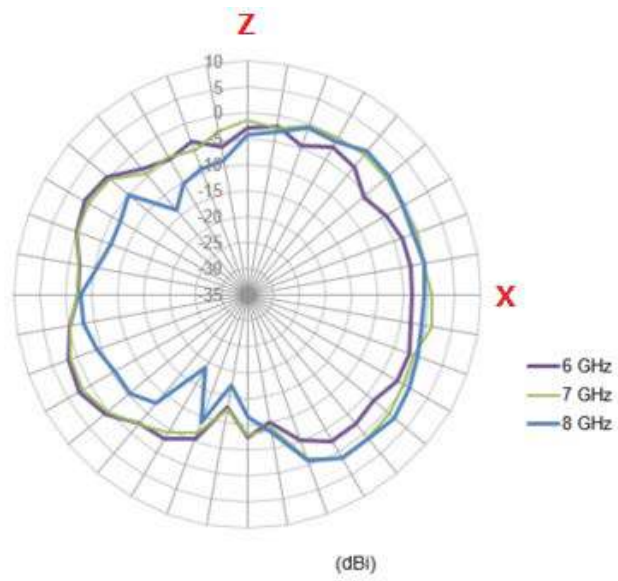

YZ Plane

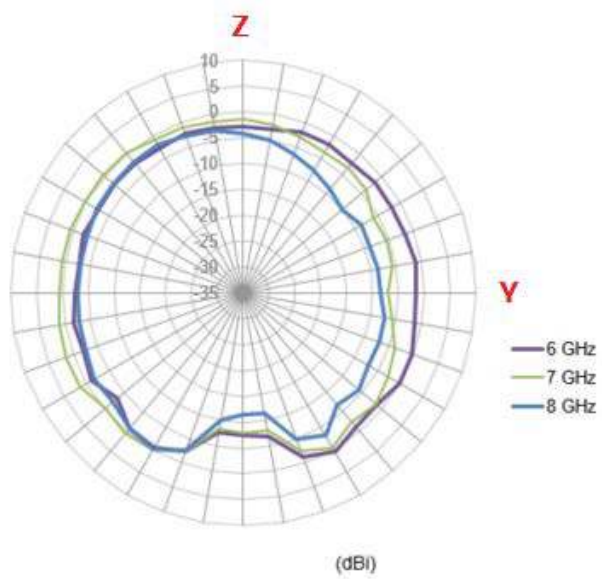

XY Plane

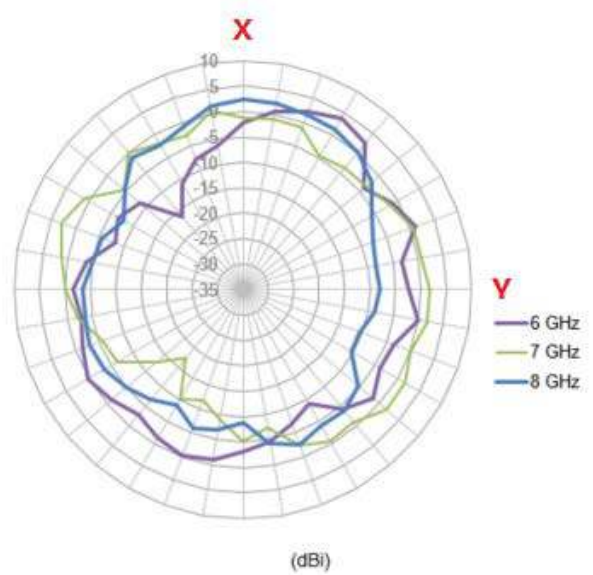

4.3. 3D Radiation Pattern

1.1.1. 6GHz

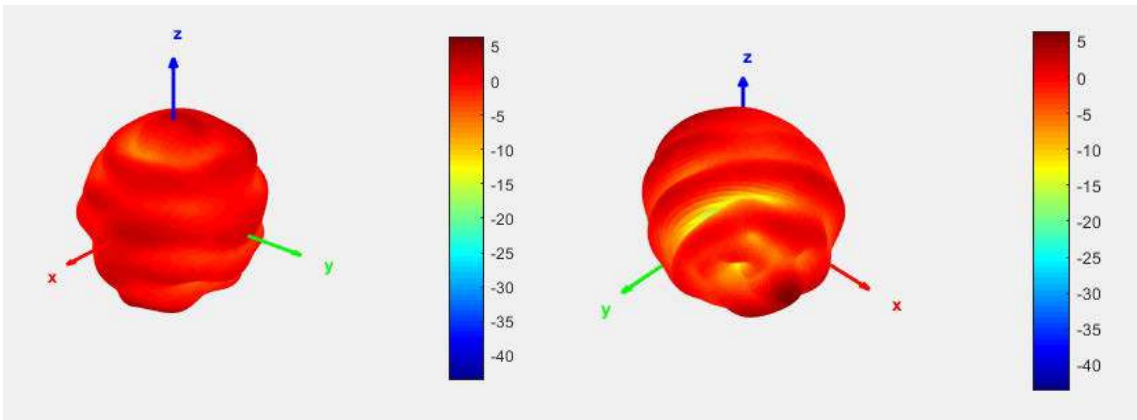

1.1.2. 6.5GHz

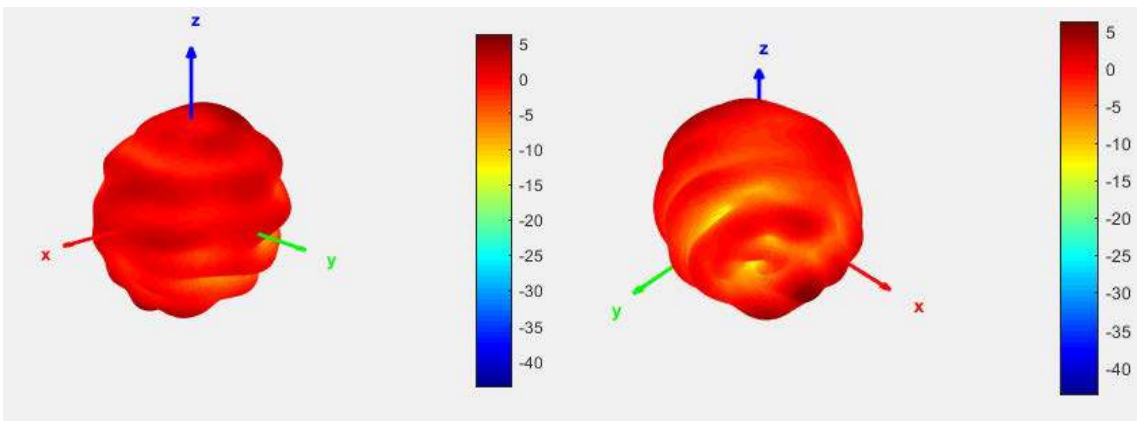

1.1.3. 6.5GHz

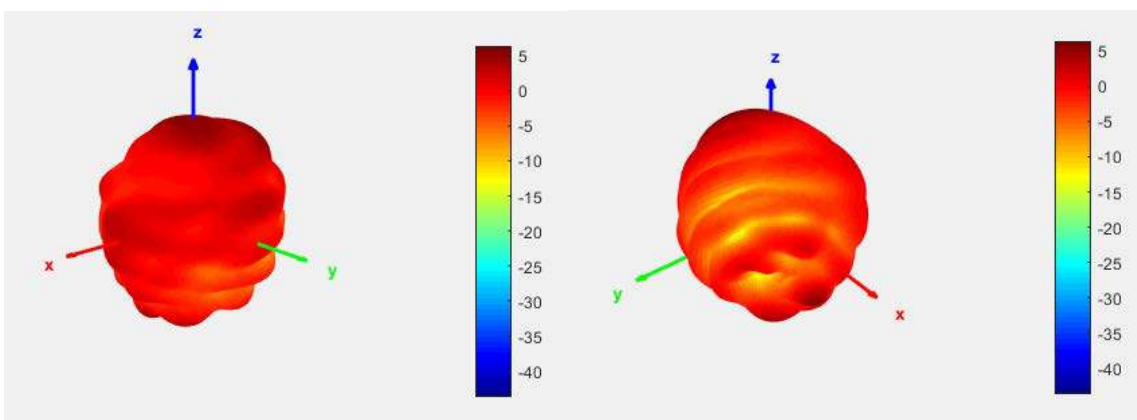

5. Mechanical Drawing (Unit: mm)

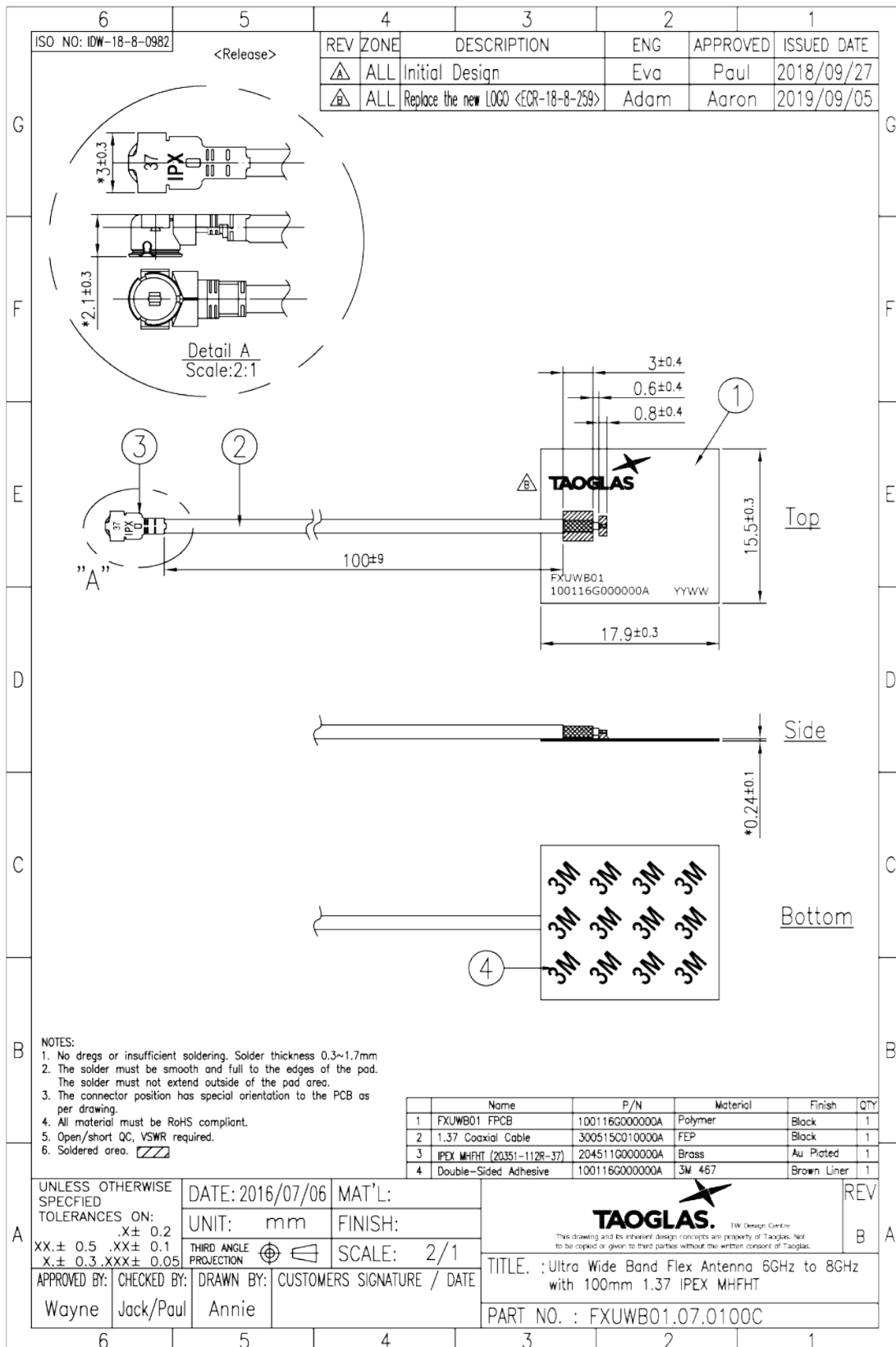

6. Packaging

100pcs FXUWB01.07.0100C per PE Bag
 Bag Dimensions - 130 x 130mm
 Weight - 78.9g

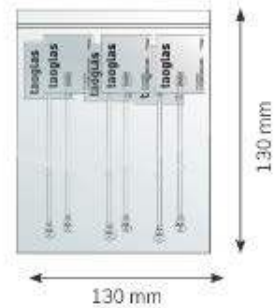

1000pcs FXUWB01.07.0100C per PE Large Bag
 Bag Dimensions - 450 x 280mm
 Weight - 0.8kg

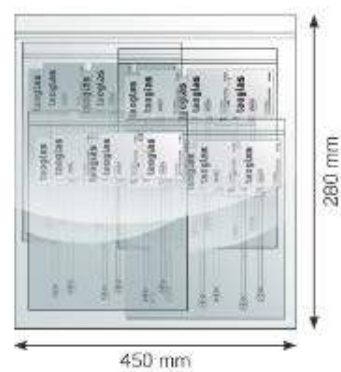

5,000 pcs FXUWB01.07.0100C per carton
 Carton - 330 x 260 x 300mm
 Weight - 4.5Kg

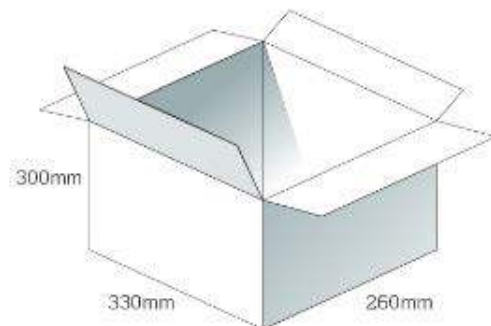

Pallet Dimensions 1200x 1000 x 1400mm
 48 Cartons per Pallet
 12 Cartons per layer
 4 Layers

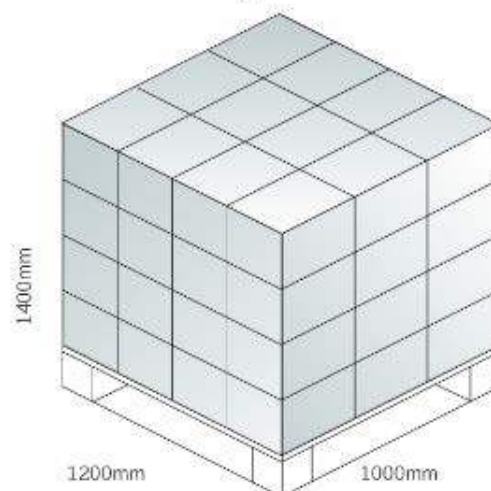

7. Application Note

7.1. Cable Routing

Cable routing is tested for this antenna, as seen below, for four possible cable routing scenarios. S_{11} shows only slight influence on the resonance in the low band (3-5 GHz) which will not influence the antenna performance negatively as the values are always below -10 dB.

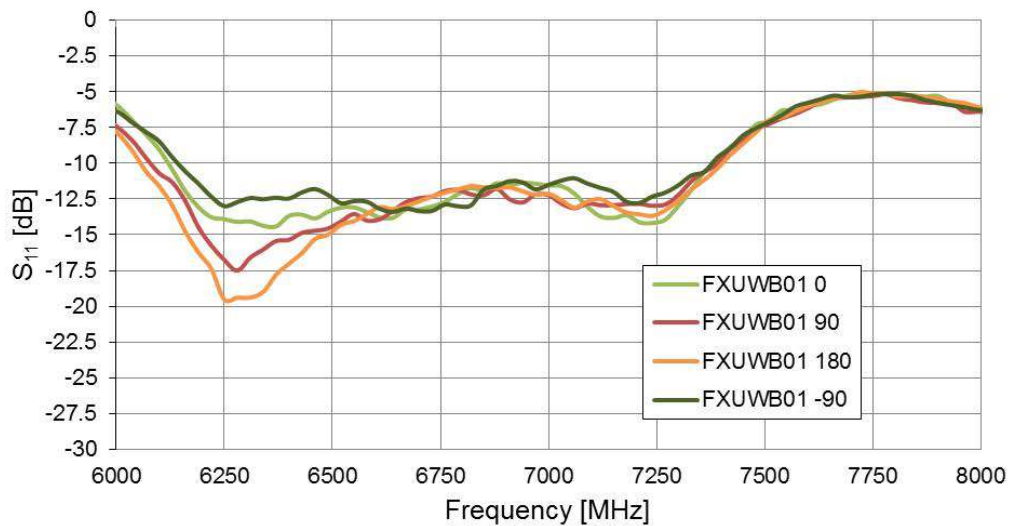
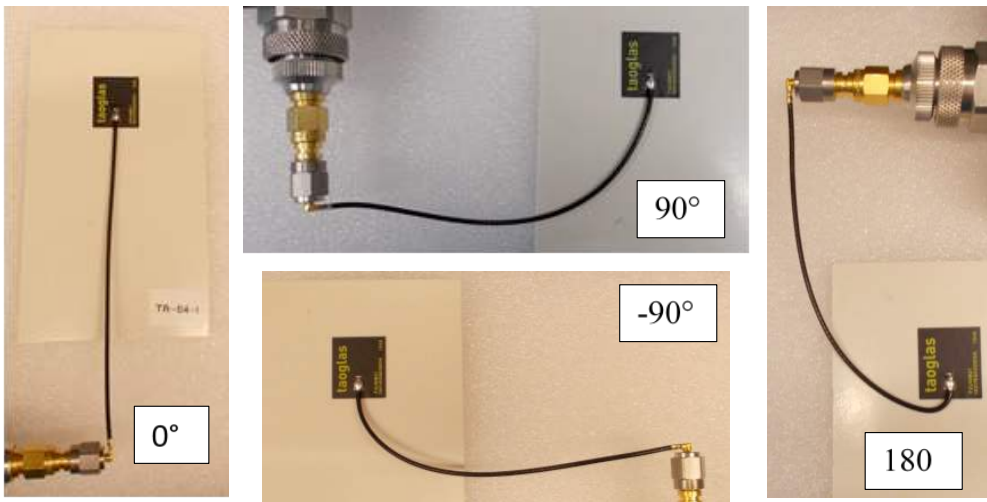

7.2. Cable Length

Cable length is tested for this antenna from 100 mm to 60 mm in 10 mm steps. As seen from the graph below the antenna response is dependent on the cable length. This is because the cable is part of the ground plane and there are currents flowing on it.

Taoglas has chosen 90 mm length as the best performance with widest impedance matching. Due to poor performance 80 mm is not recommended. Other lengths can be chosen if the frequency band is acceptable for the application.

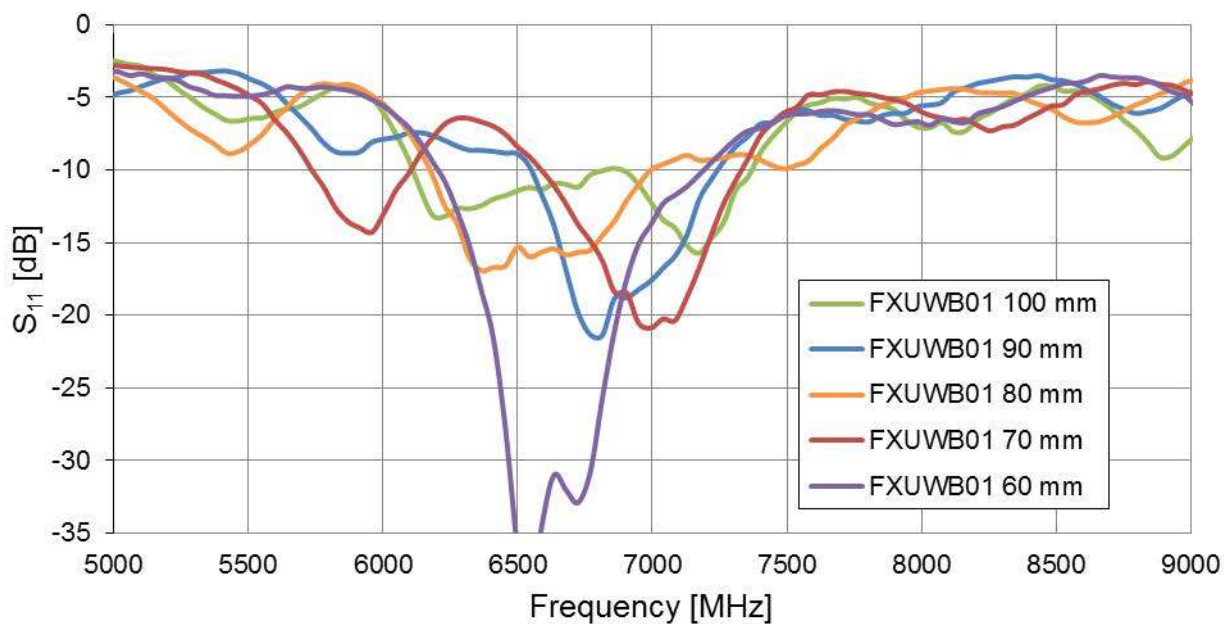

Taoglas makes no warranties based on the accuracy or completeness of the contents of this document and reserves the right to make changes to specifications and product descriptions at any time without notice.

Taoglas reserves the rights to this document and the information contained herein. Reproduction, use or disclosure to third parties without express permission is strictly prohibited.

© Taoglas