

△ 6 SIZE 12 CONTACTS (3 PLACES)

△ 6 SIZE 8 CONTACTS (1 PLACES)

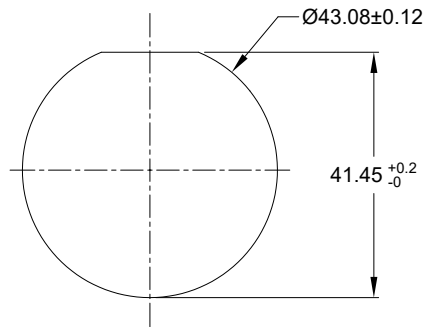
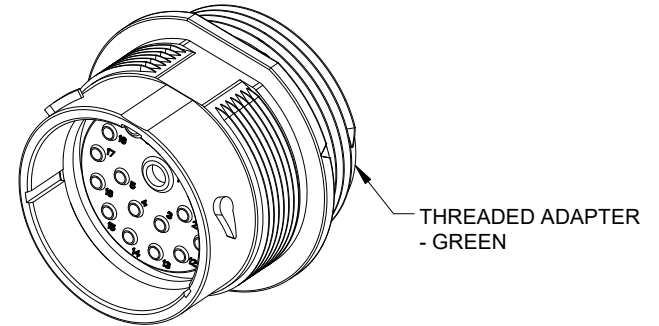
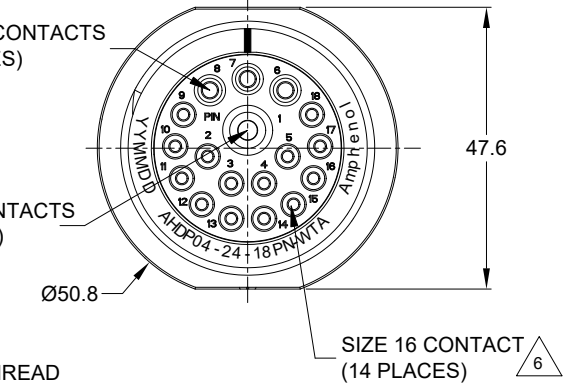

RECOMMENDED PANEL MOUNTING HOLE
RECOMMENDED PANEL THICKNESS: 1.6 TO 4.7MM

REVISIONS					
REV	ECO	DESCRIPTION	DATE	BY	APPR
A1		RELEASE NEW DRAWING	26DEC17	RIMON	TOMMY
A2	C0870S	Change the appearance of the retaining ring	27JUN18	KASOON	TOMMY
A3	--	UPDATE DIMENSION	03NOV21	LYNCH	TOMMY

NOTES: UNLESS OTHERWISE SPECIFIED

1. MATERIAL:

HOUSING: THERMOPLASTIC; BLACK
SEAL: SILICONE RUBBER

2. MODIFICATIONS: THREADED ADAPTER;
REDUCED DIA. WIRE SEAL

3. SPECIFICATIONS:

- 3.1 OPERATING TEMPERATURE: -55°C TO +125°C.
- 3.2 DIELECTRIC WITHSTANDING VOLTAGE: LESS THAN 2 MILLIAMPS CURRENT LEAKAGE @ 1500 VOLTS AC.
- 3.3 INSULATION RESISTANCE: 1000 MEGOHM MIN @ 25°C.
- 3.4 MOISTURE RESISTANCE:
IP68(IM OF WATER FOR A PERIOD OF 24 HOURS, MATED CONDITION);
IP69K(MATED CONDITION)
- 3.5 MATING CYCLE DURABILITY: 100 CYCLES
- 3.6 RoHS COMPLIANT

4. MATING PART: AHDP06-24-18S* (* = SEAL TYPE)

5. ALL DIMENSIONS ARE FOR REFERENCE USE ONLY.

△ 6 CONTACT SIZE AND WIRE RANGE:

CONTACT SIZE	MIN. INSUL O.D.	MAX. INSUL O.D.	TYPICAL WIRE RANGE	CURRENT RATING
8	4.83 mm (.190 in)	6.10 mm (.240 in)	8-10 AWG (10.0-5.0mm ²)	60 AMPS
12	3.43 mm (.135 in)	4.32 mm (.170 in)	10-14 AWG (6.0-2.0mm ²)	25 AMPS
16	2.54 mm (.100in)	3.40 mm (.134 in)	14-20 AWG (2.0-0.5mm ²)	13 AMPS



7. RECEPTACLE IS SUPPLIED WITH DUST CAP.

QUANTITY	AHDPO4-24-18PN-WTA	DESCRIPTION	ITEM
	PART NUMBER		
MATERIALS LIST			
UNLESS OTHERWISE SPECIFIED 1) All dimensions are in metric(mm). 2) Tolerances are as follows: 1 PL DEC ±0.30 2 PL DEC ±0.15 3 PL DEC ±0.08 3) Note reference = △		SIGNATURES DRAWN: LYNCHPAN CHECKED: SULLENZHANG ENGINEER: APPROVAL: TOMMY.XIE CUSTOMER:	DATE 03NOV21 03NOV21 05NOV21
MATERIAL SPECIFICATIONS: WEIGHT: 50.5G		Amphenol Sine Systems - www.amphenol-sine.com 44724 Morley Drive Clinton Township, MI 48036	
PROCESS SPECIFICATIONS:		RECEP., 24-18 POS, PIN CONTACT STANDARD DIA. SEAL, AHDP SERIES	
NEXT ASSY:	THIS DRAWING IS SUPPLIED FOR INFORMATION ONLY. DESIGN FEATURES, SPECIFICATIONS AND PERFORMANCE DATA SHOWN HEREON ARE THE PROPERTY OF THE AMPHENOL CORPORATION. NO RIGHTS OF REPRODUCTION ARE IMPLIED. ALL DIMENSIONS ARE SUBJECT TO NORMAL MANUFACTURING VARIATIONS.	SIZE B C-	DWG NO: AHDPO4-24-18PN-WTA
		SCALE: NONE	REVISION A3
		SHEET 1 OF 1	





TITLE: RECEP., 24-18 POS, PIN CONTACT, STANDARD DIA. SEAL, AHDP
DWG NO: AHDPO4-24-18PN-WTA
REV: A3
SH: 1
OF: 1

AT Series™ - Contact Size 16 Options



Machined Contacts, Sockets & Pins				
Part Number	Description	Size	AWG	Type
AT60-215-1631	Male Contact - Pin, Gold-plated	16	14	Machined
AT62-209-1631	Female Contact - Socket, Gold-plated	16	14	Machined
AT60-215-16141	Male Contact - Pin, Nickel-plated	16	14	Machined
AT62-209-16141	Female Contact - Socket, Nickel-plated	16	14	Machined
AT60-202-1631	Male Contact - Pin, Gold-plated	16	16-20	Machined
AT62-201-1631	Female Contact - Socket, Gold-plated	16	16-20	Machined
AT60-202-16141	Male Contact - Pin, Nickel-plated	16	16-20	Machined
AT62-201-16141	Female Contact - Socket, Nickel-plated	16	16-20	Machined
AT60-202-1631-22	Male Contact - Pin, Gold-plated	16	22-24	Machined
AT62-201-1631-22	Female Contact - Socket, Gold-plated	16	22-24	Machined
AT60-202-16141-22	Male Contact - Pin, Nickel-plated	16	22-24	Machined
AT62-201-16141-22	Female Contact - Socket, Nickel-plated	16	22-24	Machined

Tooling - Machined Contacts		
Part	Part Number	Description
	CA-5D12	Universal Hand Crimp Tool, Size 12/16/20 (Machined contacts only)
	CA-5E12	Pneumatic Crimp Tool, Size 12/16/20 (Machined contacts only)

Contact Removal Tools		
Part	Part Number	Description
	ATRT-100	Used for removal of contacts for A Series™ products
	AT11-310-1605	Contact Removal Tool, Plastic, Size 16

Sealing Plugs		
Part	Part Number	Description
	A114017	Sealing Plug, Size 16, White
	A114017-SR	Sealing Plug, Size 16, SR01 Series, Black
	AT13-217-1605	Locking Sealing Plug, Size 16, Grey
	AT13-217-1605-SR	Locking Sealing Plug, Size 16, SR01 Series, Red



Stamped & Formed Contacts, Sockets & Pins				
Part Number	Description	Size	AWG	Type
AT60-14-0144	Male Contact - Pin, Gold-plated	16	14-16	Stamped & Formed
AT62-14-0144	Female Contact - Socket, Gold-plated	16	14-16	Stamped & Formed
AT60-14-0122	Male Contact - Pin, Nickel-plated	16	14-16	Stamped & Formed
AT62-14-0122	Female Contact - Socket, Nickel-plated	16	14-16	Stamped & Formed
AT60-16-0144	Male Contact - Pin, Gold-plated	16	16-18	Stamped & Formed
AT62-16-0144	Female Contact - Socket, Gold-plated	16	16-18	Stamped & Formed
AT60-16-0122	Male Contact - Pin, Nickel-plated	16	16-18	Stamped & Formed
AT62-16-0122	Female Contact - Socket, Nickel-plated	16	16-18	Stamped & Formed
AT60-16-0644	Male Contact - Pin, Gold-plated	16	18-20	Stamped & Formed
AT62-16-0644	Female Contact - Socket, Gold-plated	16	18-20	Stamped & Formed
AT60-16-0622	Male Contact - Pin, Nickel-plated	16	18-20	Stamped & Formed
AT62-16-0622	Female Contact - Socket, Nickel-plated	16	18-20	Stamped & Formed
AT60-16-0844	Male Contact - Pin, Gold-plated	16	20-22	Stamped & Formed
AT62-16-0844	Female Contact - Socket, Gold-plated	16	20-22	Stamped & Formed
AT60-16-0822	Male Contact - Pin, Nickel-plated	16	20-22	Stamped & Formed
AT62-16-0822	Female Contact - Socket, Nickel-plated	16	20-22	Stamped & Formed

Tooling - Stamped & Formed Contacts		
Part	Part Number	Description
	MFY-3950	Crimp Die - Size 16, 18-20AWG (S&F contacts only)
	MFY-3953	Crimp Die - Size 16, 16-18AWG (S&F contacts only)
	MFY-3975	Crimp Die - Size 16, 14-16AWG (S&F contacts only)
	MFY-3990	Crimp Die - Size 16, 20-22AWG (S&F contacts only)
	ATT-16-00	Hand Crimp Tool - Size 16, 14-16AWG (S&F contacts only)
	ATT-16-01	Hand Crimp Tool - Size 16, 18-20AWG (S&F contacts only)
	ATT-1612-03	Hand Crimp Tool - Size 16, 20-22AWG (S&F contacts only)

DuraMate™ AHDP - Contact Size 12 Options



Machined Contacts, Sockets & Pins				
Part Number	Description	Size	AWG	Type
AT60-204-12141-10	Male Contact - Pin, Nickel-plated	12	10-12	Machined
AT62-203-12141-10	Female Contact - Socket, Nickel-plated	12	10-12	Machined
AT60-220-1231	Male Contact - Pin, Gold-plated	12	12-14	Machined
AT62-210-1231	Female Contact - Socket, Gold-plated	12	12-14	Machined
AT60-204-12141	Male Contact - Pin, Nickel-plated	12	12-14	Machined
AT62-203-12141	Female Contact - Socket, Nickel-plated	12	12-14	Machined

DiagnosticGrade™ Machined Contacts, Sockets & Pins				
• Smaller AWG for Diagnostic Applications • Gold-plated • Increased Mating Cycles • Cost-effective				
Part Number	Description	Size	AWG	Type
65-54749	Male Contact - DiagnosticGrade™, Pin, Gold-plated	12	20	Machined
AT62-210-1231-1820	Female Contact - DiagnosticGrade™, Socket, Gold-plated	12	20	Machined

Tooling - Machined Contacts		
Part	Part Number	Description
	CA-5D12	Universal Hand Crimp Tool, Size 12/16/20 (Machined contacts only)
	CA-5E12	Pneumatic Crimp Tool, Size 12/16/20 (Machined contacts only)



Contact Removal Tools		
Part	Part Number	Description
	AT11-337-1205	Contact Removal Tool, Plastic, Size 12
	A114017	Sealing Plug, Size 12, White

Stamped & Formed Contacts, Sockets & Pins				
Part Number	Description	Size	AWG	Type
AT60-12-0244	Male Contact - Pin, Gold-plated	12	10-12	Stamped & Formed
AT62-12-0244	Female Contact - Socket, Gold-plated	12	10-12	Stamped & Formed
AT60-12-0222	Male Contact - Pin, Nickel-plated	12	10-12	Stamped & Formed
AT62-12-0222	Female Contact - Socket, Nickel-plated	12	10-12	Stamped & Formed
AT60-12-0144	Male Contact - Pin, Gold-plated	12	12-14	Stamped & Formed
AT62-12-0144	Female Contact - Socket, Gold-plated	12	12-14	Stamped & Formed
AT60-12-0166	Male Contact - Pin, Nickel-plated	12	12-14	Stamped & Formed
AT62-12-0166	Female Contact - Socket, Nickel-plated	12	12-14	Stamped & Formed

Tooling - Stamped & Formed Contacts		
Part	Part Number	Description
	MFX-3973	Crimp Die - Size 12 (S&F contacts only)
	MFX-3985	Crimp Die - Size 12 (S&F contacts only) 10-12AWG -02XX Series
	ATT-12-00	Hand Crimp Tool - Size 12, 12AWG (S&F contacts only)
	ATT-12-01	Hand Crimp Tool - Size 12, 10AWG (S&F contacts only)

ATHD Series™ - Contact Size 8 Options

Machined Contacts, Pins and Sockets					
Part Number	Description	Size	AWG	Type	Amps
AT60-204-08141	Male Contact - Pin, Copper Alloy, Nickel-Plated	8	8-10	Machined	60A
AT62-203-08141	Female Contact - Socket, Copper Alloy, Nickel-Plated	8	8-10	Machined	60A
AT60-204-08141-16	Male Contact - Pin, Copper Alloy, Nickel-Plated	8	6	Machined	60A
AT62-203-08141-16	Female Contact - Socket, Copper Alloy, Nickel-Plated	8	6	Machined	60A

Tooling - Machined Contacts		
Part	Part Number	Description
	WA23	Heavy Duty Pneumatic Crimp Tool -Uses Universal Positioner Part No. WA23-101DA and Crimp Locator MFX-3961
	WA23-2	Die Assembly -for CA-5E12 Heavy Duty Pneumatic Crimp Tool, Size 8
	WA23-3	Die Assembly -for CA-5E12 Heavy Duty Pneumatic Crimp Tool, Size 6
	WA23-10	Contact Locator, Size 6 and Size 8
	96-978-22	Crimper and Dies -for Size 10mm ² -185mm ² Wires
	AT114008	Contact Removal Tool, Plastic, Size 8, 8-10AWG