



### EMI/RFI Filter with excellent attenuation for industrial applications

Datasheet 3/2019

#### APPROVALS:



SCCR by UL508A



**FIN538S1.(007 – 180).M**



**FIN538S1.(250 – 280).V**



**FIN538S1.(280 – 1750).BC**

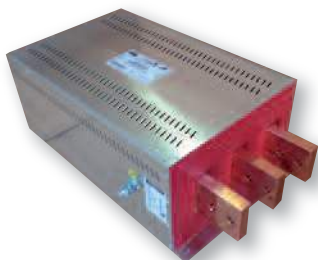

**FIN538S1.(1750 – 3000).BC**

#### FEATURES

- Rated current from 7 to 3000A
- Excellent differential and common mode attenuation
- Low leakage current
- Terminal blocks up to 180A

#### BENEFITS

- 5 Year warranty
- Various connections available
- Finger safe protection available
- Vertical bus bar available

#### MARKETS

- Electrical equipment
- Machine tools
- Industrial automation
- Frequency drives and servo drives
- Regenerative systems
- Renewable energy

#### ORDERING CODE

FIN538S1	.007	.M
Model	Current (A)	Connection
		M = Terminal block
		V = Screw
		BC = Bus bar

#### ATTENUATION INDICATOR

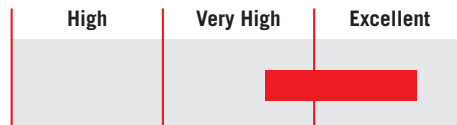

#### ELECTRIC DIAGRAM

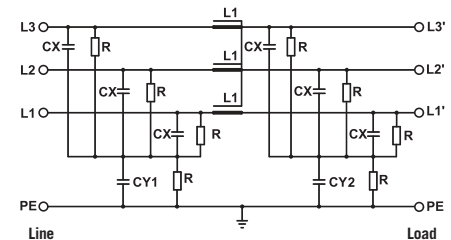

#### TECHNICAL SPECIFICATIONS

Nominal voltage	0 / 600 Vac
Frequency	50 – 60 Hz
Rated current	7 to 3000A
Potential test voltage phase to phase	2400 Vdc (2 sec.)
Potential test voltage phase to ground	3200 Vdc (2 sec.)
Leakage current normal conditions	< 10 mA *
Leakage current worst conditions	< 80 mA
IP Protection	IP20 up to 180A IP00 over 280A (IP 20 available with protection FINPRT)
Overload capability	4 x Rated current (Switch ON) 2 x In 10 seconds 1.5 In for 10 minutes
Climatic class	-40 / +85° C
MTBF at 40°C	250.000 Hrs

\* Voltage 230 Vac phase to ground 50 Hz / 40°C

### ELECTRICAL CHARACTERISTICS

FIN538S1	Rated Current 40°C	Rated Current 50°C	Power Loss (W)
.007.M	8	7	3
.016.M	18	16	4
.030.M	34	30	10
.042.M	47	42	18
.055.M	60	55	23
.075.M	83	75	37
.100.M	110	100	52
.130.M	142	130	65
.180.M	200	180	77

### CONNECTIONS

LINE			PE	
Solid Cable (mm <sup>2</sup> )	Stranded Cable (mm <sup>2</sup> )	Terminal Torque (Nm)	d (mm)	Torque (Nm)
0.2-10	0.2-6	1.2	M10	6
0.2-10	0.2-6	1.2	M10	6
0.2-10	0.2-6	1.2	M10	6
0.5-16	0.5-10	1.8	M10	6
0.5-16	0.5-10	1.8	M10	6
6-35	4-25	4.5	M10	6
10-50	10-50	4.0	M10	6
10-50	10-50	4.0	M10	6
35-95	35-95	20.0	M10	6

### TYPICAL ATTENUATION

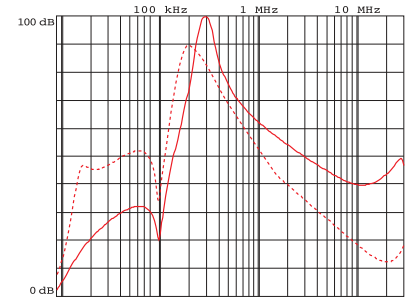

— Common Mode    - - - Differential Mode

Typical attenuation 7A – 400A

FIN538S1	Rated Current 40°C	Rated Current 50°C	Power Loss (W)
.250.V	272	250	80
.280.V	290	280	80
.280.BC	297	280	80
.320.BC	330	320	80
.360.BC	390	360	105
.400.BC	435	400	110
.500.BC	545	500	102
.600.BC	654	600	108
.750.BC	800	750	96
.900.BC	940	900	80
.1000.BC	1050	1000	115
.1250.BC	1290	1250	101
.1500.BC	1550	1500	120
.1600.BC	1650	1600	130
.1750.BC	1800	1750	135
.2000.BC	2040	2000	138
.2250.BC	2290	2250	145
.2500.BC	2535	2500	170
.3000.BC	3050	3000	180

LINE		PE	
d (mm)	Torque (Nm)	d 1 (mm)	Torque (Nm)
M12	20	M10	18
M12	20	M10	18
M8	14	M10	18
M8	14	M10	18
M8	14	M10	18
M8	14	M10	18
M8	14	M10	18
M10	25	M10	18
M10	25	M10	18
M12	50	M12	20
M12	50	M12	20
M12	50	M12	20
M12	50	M12	20
M12	50	M12	20
M12	50	M12	20
M12	50	M12	20
M12	50	M12	20
M12	50	M12	20

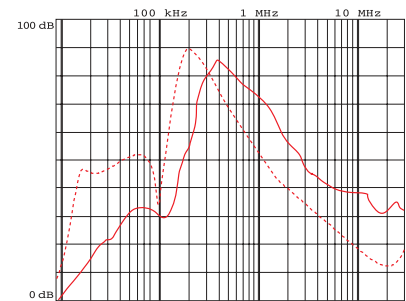

— Common Mode    - - - Differential Mode

Typical attenuation 500A – 3000A

### MECHANICAL DIMENSIONS mm

FIN538S1	A	B	V	V1	F	H	I	L	N	d	Weight Kg.	Case
.007.M	100	90	22	16	5.4	250	220	7.5	60	M6	1.3	1
.016.M	100	90	22	16	5.4	250	220	7.5	60	M6	1.3	1
.030.M	100	90	22	16	5.4	250	220	7.5	60	M6	1.3	1
.042.M	100	90	22	35	5.4	250	220	7.5	60	M6	1.5	2
.055.M	100	90	22	35	5.4	250	220	7.5	60	M6	1.5	2
.075.M	135	85	22	39	6.5	270	240	7.5	60	M6	2.2	3
.100.M	155	90	24	43	6.5	270	240	7.5	65	M10	3.2	4
.130.M	155	90	24	43	6.5	270	240	7.5	65	M10	3.2	4
.180.M	170	125	26	51	6.5	380	350	7.5	102	M10	5.5	5

### CASE 1, 2, 3, 4, 5

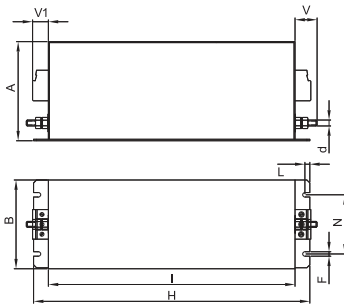

### ASSEMBLY CONNECTION "M"

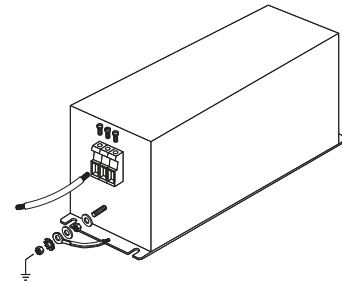

### MECHANICAL DIMENSIONS mm

FIN538S1	A	B	C	d	d1	V	F	H	I	L	N	P	S	Weight Kg.	Case
.250.V	90	220	120	M12	M10	30	6.5	356	320	340	95	70	60	9	6
.280.V	90	220	120	M12	M10	30	6.5	356	320	340	95	70	60	9	6

### CASE 6

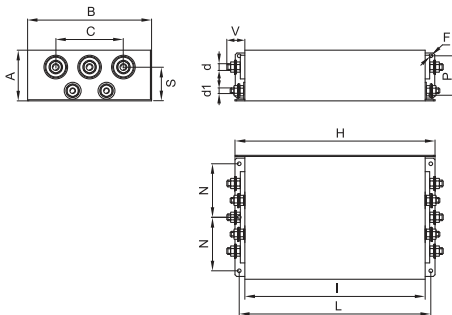

### ASSEMBLY CONNECTION "V"

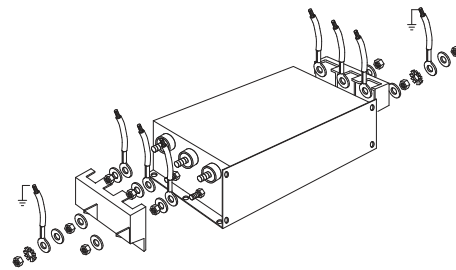

### MECHANICAL DIMENSIONS mm

FIN538S1	A	B	C	d	d1	d2	d3	V	F	H	I	L	N	P	S	Weight Kg.	Case
.280.BC	90	220	120	M8	M10	6	20	42	6.5	356	320	340	95	70	55	9	7
.320.BC	90	220	120	M8	M10	6	20	42	6.5	356	320	340	95	70	55	9	7
.360.BC	130	230	150	M8	M10	10	25	42	6.5	420	380	400	100	100	85	13.5	8
.400.BC	130	230	150	M8	M10	10	25	42	6.5	420	380	400	100	100	85	13.5	8
.500.BC	130	230	150	M8	M10	10	25	42	6.5	420	380	400	100	100	85	13.5	8
.600.BC	130	230	150	M12	M10	15	30	48	6.5	510	450	480	100	100	85	19	9
.750.BC	130	230	150	M12	M10	15	30	48	6.5	510	450	480	100	100	85	19	9
.900.BC	160	250	140	M12	M12	20	40	94	8.5	510	450	480	100	110	110	27	10
.1000.BC	160	250	140	M12	M12	20	40	94	8.5	510	450	480	100	110	110	27	10
.1250.BC	160	250	140	M12	M12	20	40	94	8.5	510	450	480	100	110	110	27	10
.1500.BC	180	300	200	M12	M12	20	60	97	8.5	560	500	530	125	130	117	30	11
.1600.BC	180	300	200	M12	M12	20	60	97	8.5	560	500	530	125	130	117	30	11
.1750.BC	180	300	200	M12	M12	20	60	97	8.5	560	500	530	125	130	117	30	11
.2000.BC	225	350	200	M12	M12	25	80	100	8.5	610	550	580	150	-	113	68	12
.2250.BC	225	350	200	M12	M12	25	80	100	8.5	610	550	580	150	-	113	68	12
.2500.BC	225	350	200	M12	M12	25	80	100	8.5	610	550	580	150	-	113	68	12
.3000.BC	225	350	200	M12	M12	25	80	100	8.5	610	550	580	150	-	113	68	12

### CASE 7, 8, 9

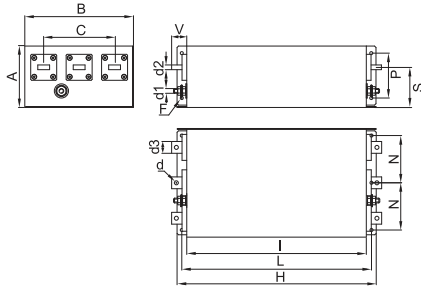

### ASSEMBLY CONNECTION "BC"

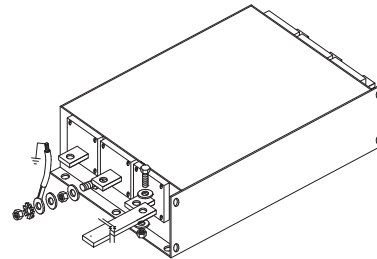

### CASE 10, 11

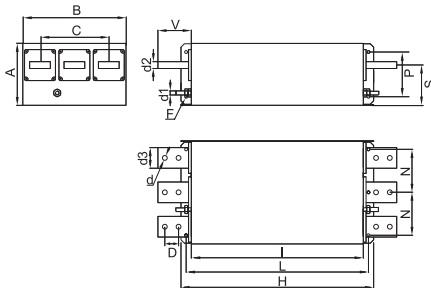

### ASSEMBLY CONNECTION "BC"

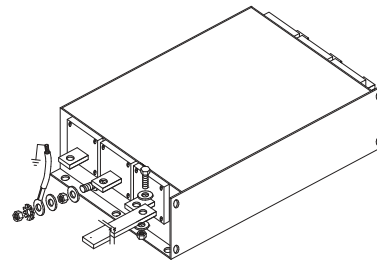

### CASE 12

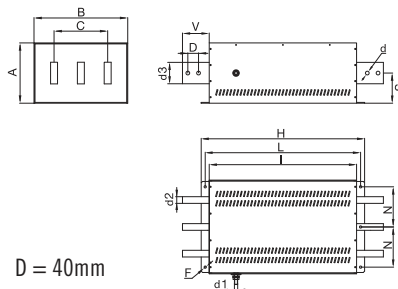

### ASSEMBLY CONNECTION "BC"

