

COOL POWER TECHNOLOGIES

1" x 2" Isolated DC/DC Converter

Features

- Ultra-wide input voltage range: 9 – 36Vin
- Output: 5V at 15A, 75W max.
- High Efficiency 90% typical @ FL
- RoHS 3 Directive 2015/863/EU
- Withstands 50 V input transients
- On-board input differential LC-filter
- Meets UL94, V-0 flammability rating
- Fixed-frequency operation
- No minimum load/capacitance required
- Low height - 0.410" (10.4 mm) encapsulated
- Open frame model 0.330" (8.39 mm) tall
- Industry standard 1" x 2" footprint
- Available in through-hole and SMT versions
- Full protection (OTP, OCP, OVP, UVLO – auto-restart)
- Compliant to REACH (EC) No 1907/2006, 205 SVHC update
- Remote ON/OFF - positive or negative enable logic options
- Output voltage trim range: $\pm 10\%$
- Weight: 1.38 oz (39.1 g) encapsulated model, 0.7 oz (19.8 g) open frame
- Complies with UL/CSA60950-1, TUV per IEC/EN60950-1, 2nd edition
- Designed to meet Class B conducted emissions per FCC and EN55032 when used with external filter (see EMC Compliance section below.)



Description

The CP75_1115218 “Cool Power Technologies” DC-DC converter is an encapsulated 1”x2” DC-DC module that conforms to industry standard specifications. The converter operates over an input voltage range of 9 to 36 VDC, and provides a tightly regulated output voltage with an output current rating of 15 Amps. The output is fully isolated from the input. The standard feature set includes remote On/Off (positive or negative enable), input undervoltage lockout, output overvoltage protection, overcurrent and short circuit protections, output voltage trim and overtemperature shutdown with hysteresis. The high efficiency of the CP75_1115218 allows operation over a wide ambient temperature range with minimal derating.

TABLE OF CONTENTS

SECTION	PAGE
FEATURES & DESCRIPTION	1
APPLICATION DIAGRAM	2
ELECTRICAL SPECIFICATIONS	3
CHARACTERISTIC PERFORMANCE CURVES	6
CHARACTERISTIC WAVEFORMS	7
APPLICATION NOTES	8
<ul style="list-style-type: none"> • RIPPLE MEASUREMENTS TEST SET-UP 	8
<ul style="list-style-type: none"> • OUTPUT VOLTAGE TRIM EQUATIONS 	9
<ul style="list-style-type: none"> • THERMAL DERATING 	10
<ul style="list-style-type: none"> • EMC COMPLIANCE 	12
MECHANICAL OUTLINE & PCB FOOTPRINT	13
ORDERING INFORMATION	15

APPLICATION DIAGRAM

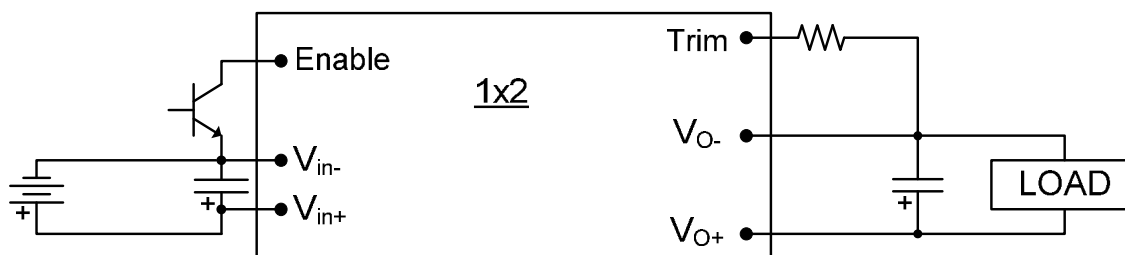

ELECTRICAL SPECIFICATIONS

9–36Vin, 5V/15Aout

Conditions: $T_A = 25\text{ }^\circ\text{C}$, Airflow = 300 LFM, $V_{in} = 24\text{ VDC}$, $C_{in} = 220\text{ }\mu\text{F}$, unless otherwise specified.

Input Characteristics					
Parameter	Conditions	Min	Typ	Max	Unit
Operating Input Voltage Range		9	24	36	VDC
Input Under-Voltage Lock-out Turn-on Threshold ¹ Turn-off Threshold		8.8 7.6	9 7.9	9.2 8.2	VDC
Input Voltage Transient	100ms			50	VDC
Maximum Input Current	$V_{IN} = 9\text{VDC}; I_{out} = 15\text{A}$			9.8	A
Input Standby Current	Converter Disabled		2	5	mA
Input No-Load Current	Converter Enabled		80	100	mA
Short Circuit Input Current	RMS		30		mA
Input Reflected Ripple Current	5Hz to 50MHz See Fig 11 for setup		30	50	mA _{PK-PK}
Input Voltage Ripple Rejection	120Hz		60		dB
Inrush Current	All	-	-	0.1	A ² /s
Output Characteristics					
Parameter	Conditions	Min	Typ	Max	Unit
Output Voltage Set point	Sense pins connected to output pins	4.925	5.00	5.075	VDC
Output Current		0		15	A
Output Current Limit Inception		18	22	30	A
Peak Short-Circuit Current	10mΩ Short			30	A
RMS Short-Circuit Current	10mΩ Short			6	A _{RMS}
External Load Capacitance ²	+ Full resistive load	0		20000 ²	uF
Output Ripple and Noise	20MHz Bandwidth 1 uF Ceramic + 10uF Tantalum See Fig 12 for setup		50	100	mV _{PK-PK}
Output Regulation Line: Load: Overall Output Regulation:	Over line, load & temp.	4.88	±3 ±5	±10 ±20 5.12	mV mV V



ELECTRICAL SPECIFICATIONS (continued)

9–36Vin, 5V/15Aout

Conditions: $T_A = 25\text{ }^\circ\text{C}$, Airflow = 300 LFM, $V_{in} = 24\text{ VDC}$, $C_{in} = 220\text{ }\mu\text{F}$, unless otherwise specified.

Absolute Maximum Ratings					
Parameter	Conditions	Min	Typ	Max	Unit
Input Voltage	Continuous Operation	0		36	VDC
Operating Ambient Temperature	w/derating	-40		+85	$^\circ\text{C}$
Operating Temperature	Open Frame	-40		+125	$^\circ\text{C}$
	Encapsulated Module	-40		+105	$^\circ\text{C}$
Storage Temperature		-55		+125	$^\circ\text{C}$
Feature Characteristics					
Parameter	Conditions	Min	Typ	Max	Unit
Switching Frequency			430		kHz
Output Voltage Trim Range ¹		-10		+10	%
Remote Sense Compensation ¹				+10	%
Output Over-voltage Protection	Non-latching	115	125	140	%
Over-temperature Protection	Avg. PCB temp, non-latching		135		$^\circ\text{C}$
Peak Backdrive Output Current during startup into prebiased output	Sinking current from external voltage source equal to $V_{OUT} - 0.6\text{V}$ and connected to the output via 1Ω resistor. $C_{OUT}=220\mu\text{F}$, Aluminum		900		mA
Backdrive Output Current in OFF state	Converter disabled		0	5	mA
Enable to Output Turn-ON Time	$V_{OUT} = 0.9 \cdot V_{OUT_NOM}$		30		ms
Output Enable ON/OFF	Negative Enable	Converter ON	-0.5	0.8	VDC
		Converter OFF	2.4	20	VDC
	Positive Enable	Converter ON	2.4	20	VDC
		Converter OFF	-0.5	0.8	VDC
Enable Pin Current Source/Sink	Converter has internal pull-up of approx. 5V		0.25	1	mA
Output Voltage Overshoot @ Startup			0	2	%Vo
Auto-Restart Period	(all protection features)		200		ms



ELECTRICAL SPECIFICATIONS (continued)

9–36Vin, 5V/15Aout

Conditions: Ta = 25 °C, Airflow = 300 LFM, Vin = 24 VDC, Cin=220 µF, unless otherwise specified.

Efficiency					
Parameter	Conditions	Min	Typ	Max	Unit
Full Load	Vin = 12Vin	89	90		%
	Vin = 24Vin	89	90		%
60% Load	Vin = 12Vin	90	91		%
	Vin = 24Vin	89	90		%
Dynamic Response					
Parameter	Conditions	Min	Typ	Max	Unit
Load Change 50%-75% or 25% to 50% of Iout Max, di/dt = 0.1 A/µs	Co = 1 µF ceramic + 10 µF tantalum		150	200	mV
Settling Time to 1% of Vout			50		µs
Load Change 25%-75% of Iout Max, di/dt = 0.1 A/µs	Co = 1 µF ceramic + 10000 µF electrolytic		50	100	mV
Settling Time to 1% of Vout			50		µs
Isolation Specifications					
Isolation Capacitance			1000		pF
Isolation Resistance		10			MΩ
Isolation Voltage	Input to Output - Open Frame	2000			V _{DC}
	Input to Output – Encapsulated	1600			V _{DC}
Reliability					
Per Telcordia SR-332, Issue 2: Method I, Case 3 (Io=80% of Io_max, TA=40°C, airflow = 200 lfm, 90% confidence)	MTFB – Encapsulated		2,119,512		Hours
	MTFB – Open Frame		3,130,580		Hours

Notes:

1. Combination of remote sense + trim up not to exceed 10% of V_{onm}
2. Higher capacitive load handling available, consult factory. Cold start @-40C, 15000uF max.



CHARACTERISTIC CURVES:

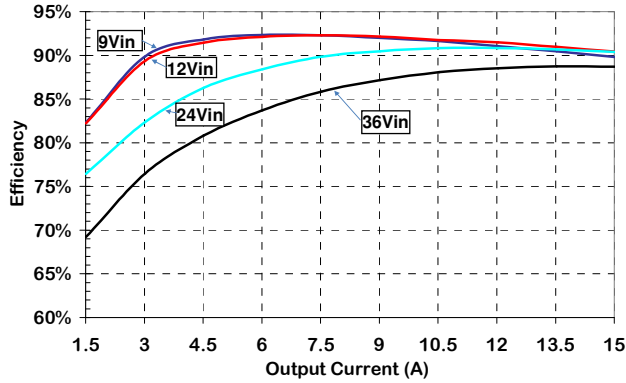

Figure 1. Efficiency vs Output Current, 300lfm airflow, 25°C ambient.

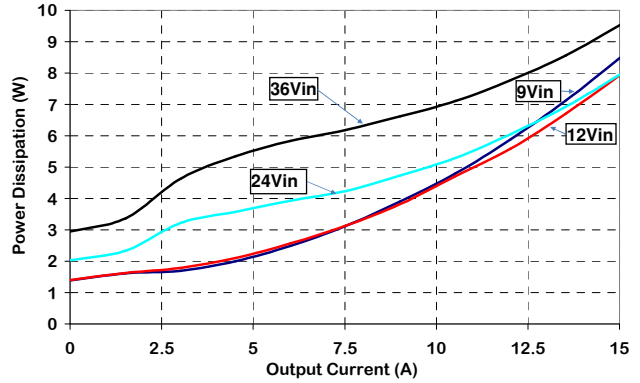

Figure 2. Power Dissipation vs. Load Current, 300lfm airflow, 25°C ambient.

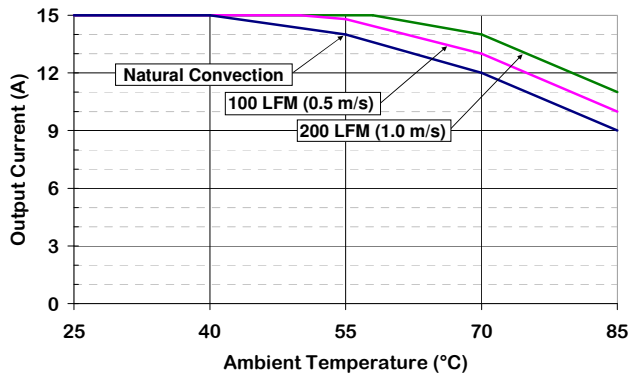

Figure 3. Output Current Derating vs Ambient Temperature & Airflow (air flowing from pin 3 to pin 1, encapsulated module), Vin = 24Vin

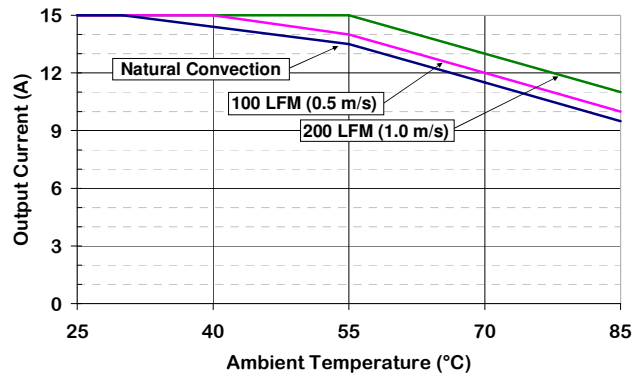

Figure 4. Output Current Derating vs Ambient Temperature & Airflow (air flowing from pin 3 to pin 1, open frame), Vin = 24Vin



CHARACTERISTIC WAVEFORMS:

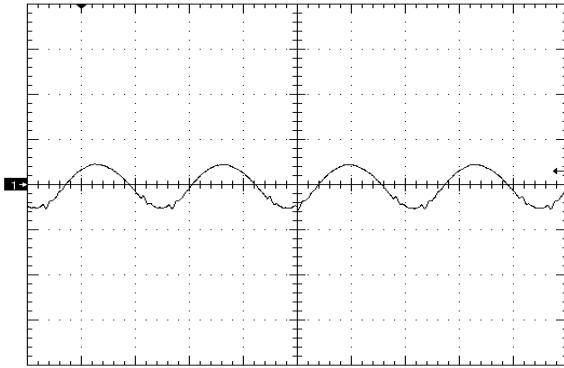

Figure 5. Output Voltage Ripple (50mV/div), time scale – 1uS/div. Vin=Vin_nom, full resistive.

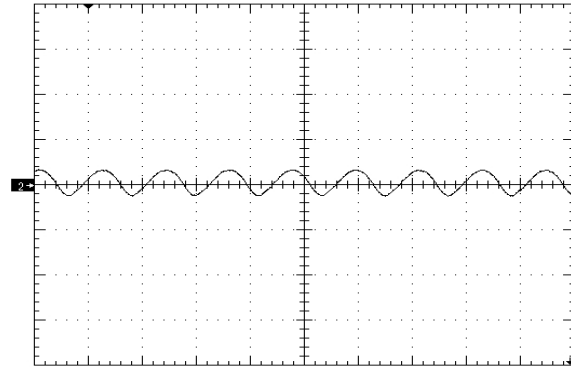

Figure 6. Input Reflected Ripple Current (50mA/div) time scale - 2uS/div. Vin=Vin_nom, full resistive.

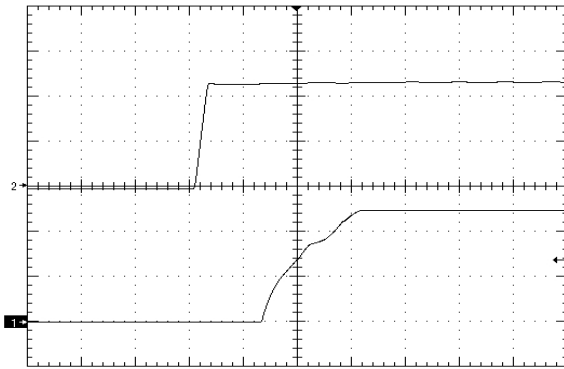

Figure 7. Startup Waveform via Line Voltage, time scale 10mS/div. Vin=Vin_nom, no load Ch1=2V/div, Ch2=10V/div

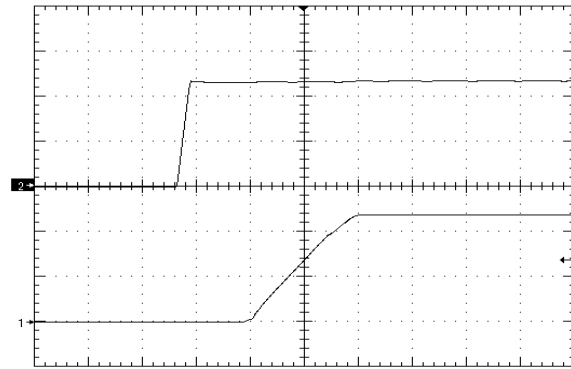

Figure 8. Startup Waveform via Line Voltage, time scale 10mS/div. Vin=Vin_nom, full resistive load + 20000uF Ch1=2V/div, Ch2=10V/div

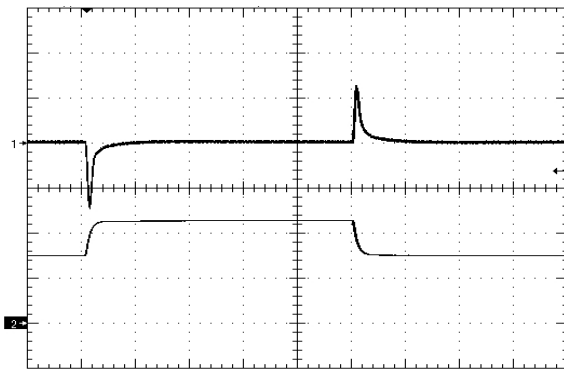

Figure 9. Load Transient Response (100mV/div), di/dt=0.1A/uS, 50% - 75% - 50% of full load, time scale: 200uS/div. Ch2=5A/div

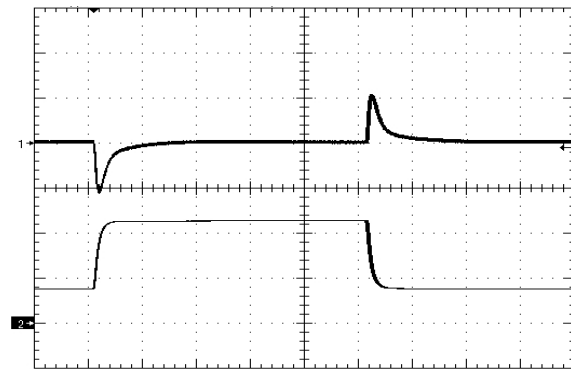
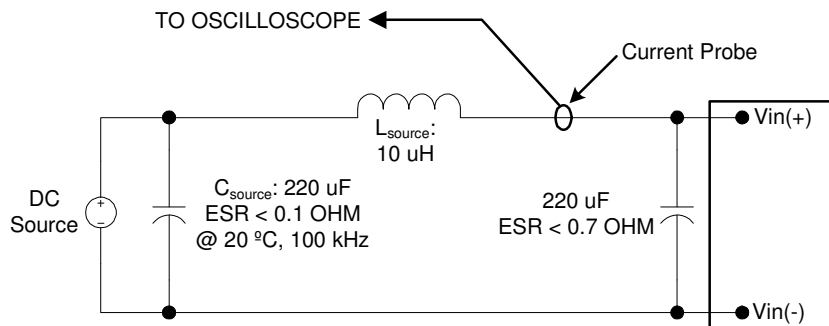

Figure 10. Load Transient Response (100mV/div), di/dt=0.1A/uS, 25% - 75% - 25% of full load +10000uF time scale: 200uS/div. Ch2=5A/div

Application Notes

Input Voltage Reflected Ripple Measurement

- INPUT REFLECTED RIPPLE TEST SETUP:



Note: Measure input reflected-ripple current with a simulated source inductance (L_{test}) of 10 μ H. Capacitor C_s offsets possible source impedance.

Figure 11. Input Reflected-ripple Current Test Setup.

Output Voltage Ripple Measurement

- OUTPUT RIPPLE TEST SETUP:

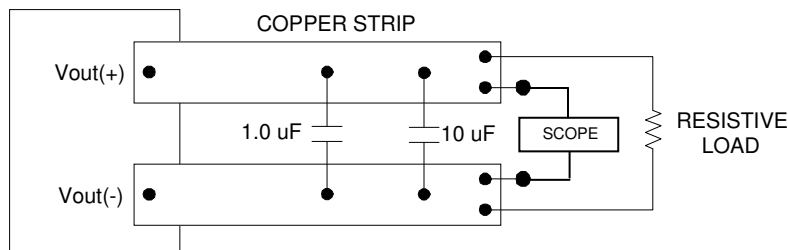

Note: Use a 1 μ F X7R ceramic capacitor and a 10 μ F tantalum capacitor. Scope measurement should be made using a BNC socket. Position the load 3 in. [76mm] from module.

Figure 12. Peak-to-Peak Output Noise Measurement Test Setup.

Application Notes (cont)

Output Voltage Trim

Output voltage adjustment is accomplished by connecting an external resistor between the Trim Pin and either the + or – Vout pins.

- TRIM UP EQUATION:**

$$R_{\text{TRIM_UP}}(\Omega) = \frac{12750}{V_{\text{DES}} - 5} - 2050$$

Where $R_{\text{TRIM_UP}}$ is the resistance value in ohms and V_{DES} is the desired output voltage.

E.g. to trim the output up 10%, $R_{\text{TRIM_UP}}(\Omega) = \frac{12750}{5.5 - 5} - 2050$ or $R_{\text{TRIM_UP}} = 23.45 \text{ k}\Omega$.

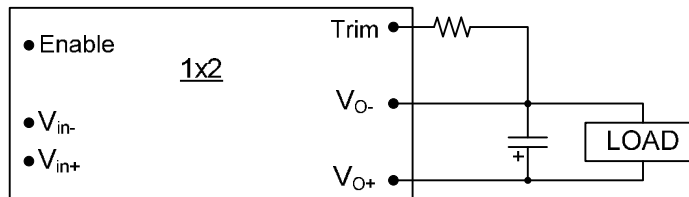

Figure 13. Trim UP circuit configuration

- TRIM-DOWN EQUATION:**

$$R_{\text{TRIM_DOWN}}(\Omega) = \frac{5100 \cdot (V_{\text{DES}} - 2.5)}{5 - V_{\text{DES}}} - 2050$$

Where $R_{\text{TRIM_DOWN}}$ is the resistance value in ohms and V_{DES} is the desired output voltage.

E.g. to trim the output down 10%, $R_{\text{TRIM_DOWN}}(\Omega) = \frac{5100 \cdot (5.5 - 2.5)}{5 - 4.5} - 2050$ or $R_{\text{TRIM_DOWN}} = 28.55 \text{ k}\Omega$

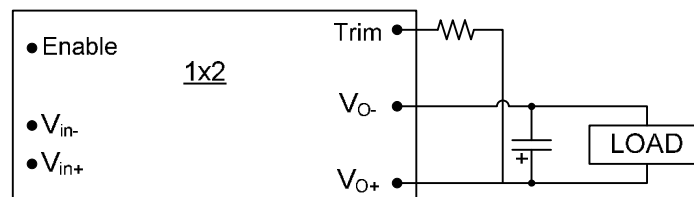
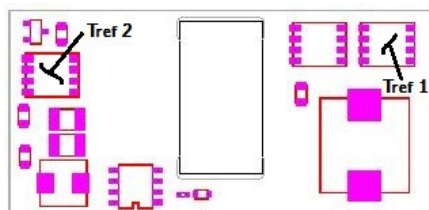

Figure 14. Trim DOWN circuit configuration

Application Notes (cont)

Thermal Derating

- It is preferable that the DC-DC module have an unobstructed flow of air across it for best thermal performance. Components taller than ~ 2mm in front of the module can deflect airflow and possibly create hotspots.
- Significant cooling is achieved through conductive flow from the modules I/O pins to the host PCB. Sufficiently large traces connecting the dc-dc converter to the source and load will help ensure thermal derating performance will meet or exceed the derating curves published in this datasheet.
- If the module is expected to be operated near the load limits defined in the derating curves, in-system verification of module derating performance should be performed to ensure long-term system reliability. Peak temperatures are to be measured using infrared thermography or by gluing a fine gauge (AWG #40) thermocouple at the T_{ref} location(s) shown below. $T_{ref,2}$ should be monitored for input voltages below 18 Vin, $T_{ref,1}$ for input voltages > 18 Vin. Temperatures at the specified location(s) should be limited to 125°C. For encapsulated models, T_{CASE} should not exceed 105°C.



Open Frame Measurement Points

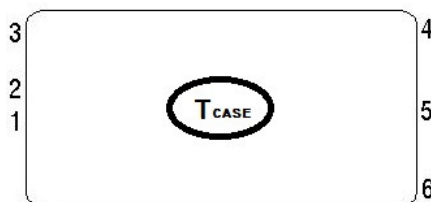

Encapsulated Module Hotspot

Input Undervoltage Lockout

- The converter is disabled until the input voltage has exceeded the UVLO turn-on threshold. Once the input voltage exceeds this level (see Input Under-Voltage Lock-out in Electrical Specifications table) the module will commence soft-start. Hysteresis minimizes the likelihood of pulling the input voltage below the turn-off threshold during startup which could create an undesirable on/off cycling condition. The converter will continue to operate until the input voltage subsequently falls below the UVLO turn-off threshold.

Enable Pin Function

- The module has a remote enable function that allows it to be turned on or off remotely. The Enable pin is referenced to the negative input pin (-Vin) of the converter. Modules can be ordered with either negative or positive enable.
- The negative enable option the module will not turn on unless the enable pin is connected to -Vin. The positive enable option allows the converter to turn on as soon as voltage sufficient to exceed the UVLO of the converter has been applied to the input terminals. In this case the module is turned off by connecting the Enable pin to -Vin. On/off thresholds are located in the Electrical Specifications table.



Application Notes (cont)

Output Overvoltage Protection

- The module has an independent feedback loop that will disable the output of the converter if a voltage greater than about 125% of the nominal set point is detected. When this threshold is reached, the converter will shut down and remain off for the amount of time specified by the Auto-Restart Period. The converter will attempt a restart once this period of time has elapsed.

Output Overtemperature Protection

- To provide protection under certain fault conditions, the unit is equipped with a thermal shutdown circuit. The unit will shutdown if the average PCB temperature exceeds approx. 135°C, but the thermal shutdown is not intended as a guarantee that the unit will survive temperatures beyond its rating. The module will automatically restart once it has cooled below the shutdown temperature minus hysteresis (typically 20 deg C.)

SMT Version Layout Considerations (if applicable)

- Copper traces with sufficient cross-section must be provided for all output & input pins. SMT pads tied to internal power/ground planes must have multiple vias around each SMT pad to couple expected current loads from module pins into internal traces/planes. One 0.024" (0.6mm) diameter via for each 4A of expected source or load current must be provided as close to the termination as possible, preferably in the direction of current flow from SMT pad to load. Vias must be at least 0.024" (0.6 mm) away from the SMT pad to prevent solder from flowing into the vias.
- SMT pads on the host card are to be 0.080" (2.03 mm) diameter. Solder paste screen opening should be 0.075" (1.9 mm) diameter and the screen should be 0.006" (0.15 mm) thick (other thicknesses are possible; 0.006" provides a good compromise between solder volume and coplanarity compensation.)

Paralleling Converters

- Modules may be paralleled but it is recommended that the total power draw not exceed the output power rating of a single module. External sharing controllers are recommended for reliability and to ensure equal distribution of the load to the converters.



Application Notes (cont)

EMC Compliance

To meet Class B compliance for EN55032 (CISPR 32) or FCC part 15 sub part j, the following input filter is required:

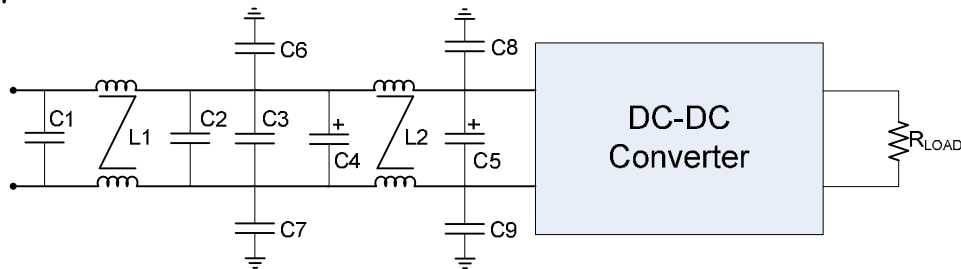

Figure 17. EMI Filter

L1, L2 =	0.63 mH Common Mode Inductor (Pulse P0469)
C1, C2, C3 =	2.2uF ceramic
C4 =	Not used
C5 =	220uF electrolytic
C6, C7 =	8.2nF (@2kV if output is ref. to gnd.)
C8, C9 =	8.2nF (@2kV if output is ref. to gnd.)

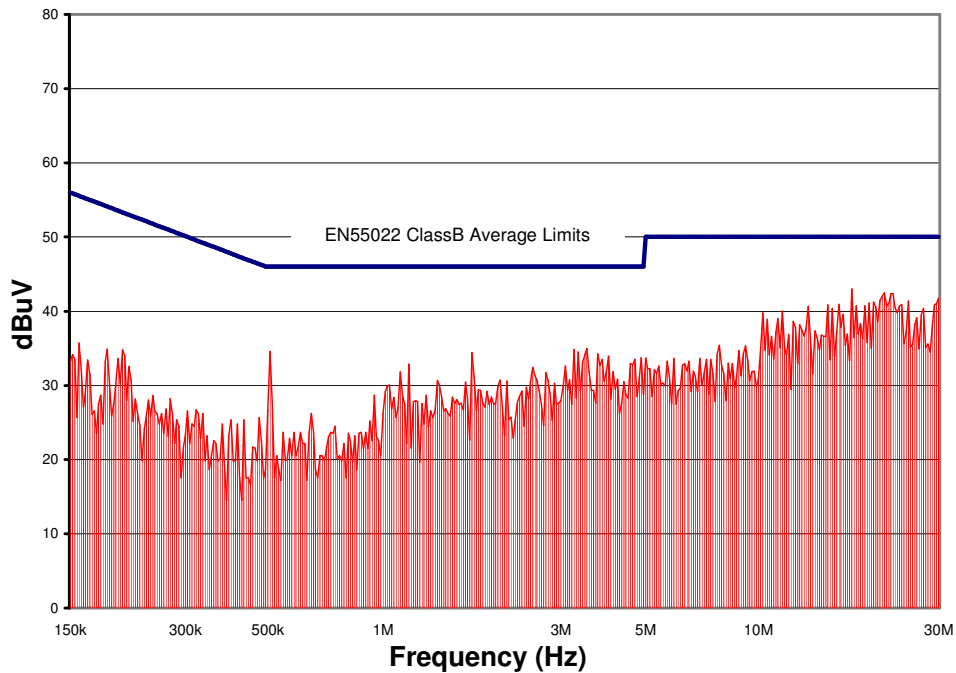
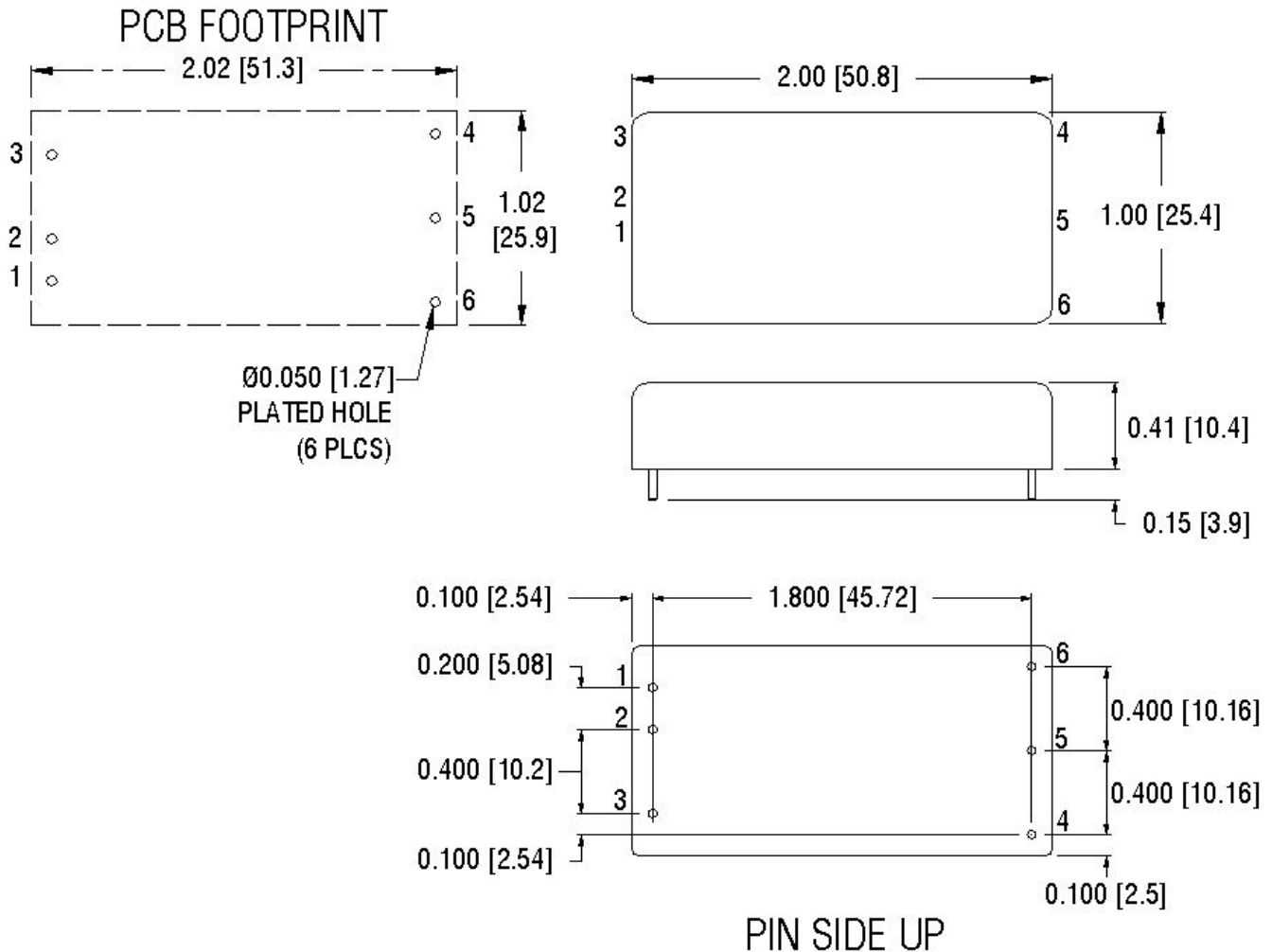

Figure 18. CP75_1115218 Conducted Emissions using above specified input filter, Vin = 24V, Full Resistive Load

MODULE PIN ASSIGNMENT:

PIN #	DESIGNATION	NOTES
1	V _{IN} (+)	1) All dimensions in inches [mm] Tolerances: .xx ± 0.02 [.x ± .5] .xxx ± 0.010 [.xx ± .25] 2) TH pins Ø 0.040" [1.02] with Ø 0.070" [1.77] standoff shoulders. 3) SMT pins are Ø 0.070" lead-free 4) All pins are gold plated with nickel under plating. 5) Keep Out Area – no copper traces or vias should be placed in this area 5) Weight: 19.8 g (0.7 oz.) open frame, 39.1 g (1.38 oz.) encapsulated module 6) Workmanship: Meet or exceeds IPC-A-610 Class II
2	V _{IN} (-)	
3	On/Off	
4	Trim	
5	V _{OUT} (-)	
6	V _{OUT} (+)	

MECHANICAL OUTLINE – Encapsulated module:



MECHANICAL OUTLINE – Open frame:

THRU-HOLE:

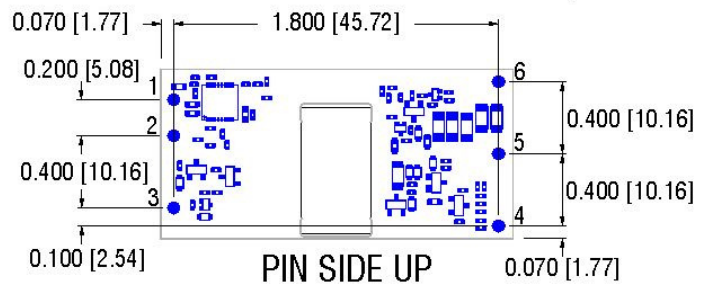
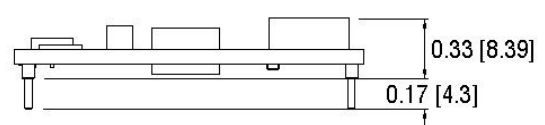
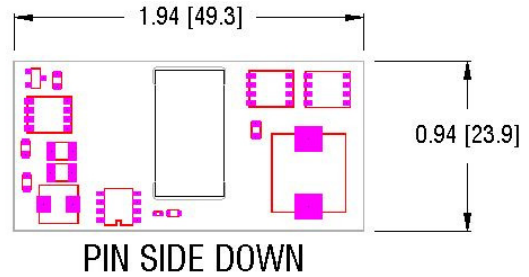
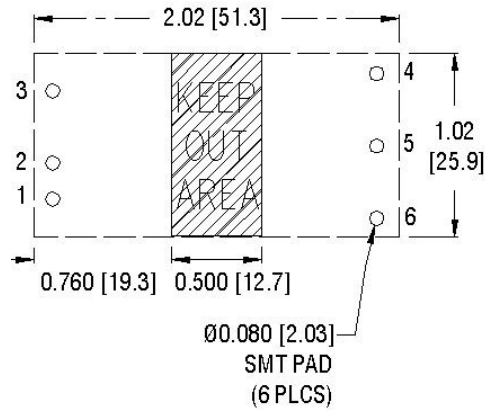

SMT:

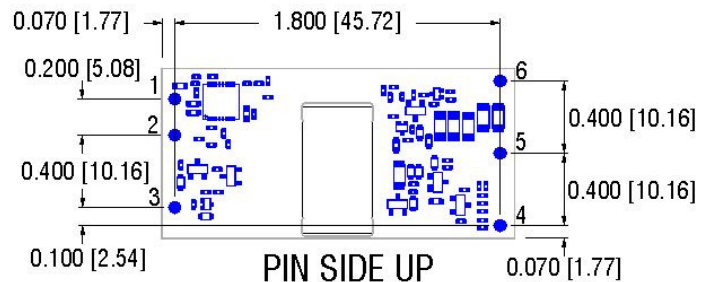
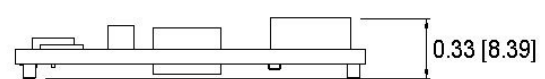
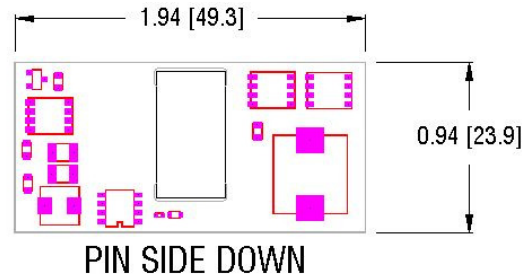
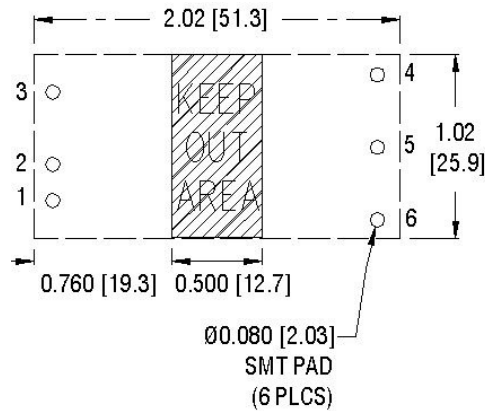

Ordering Information:

Product Series	Package Configuration	No. of Outputs	Output Voltage	Output Current	Input Voltage	Enable logic option	SMT Option
CP75	B or C	1	1	152	18	N or P	S
75W 1x2	B = Open Frame C = Encapsulated	1 output	5V	15A	9 – 36V	N = Negative P = Positive Blank = No Trim or Enable Pin	Surface Mount

* Note: unit cannot be ordered with both encapsulated and surface mount options

Rev 1.0, 29-March-20

