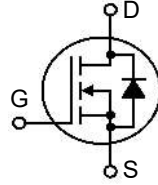


Linear™
Power MOSFET
w/Extended FBSOA

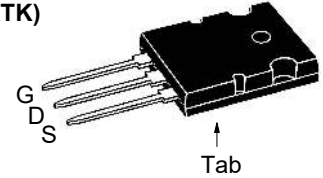
IXTK8N150L
IXTX8N150L

V_{DSS} = 1500V
I_{D25} = 8A
R_{DS(on)} ≤ 3.6Ω

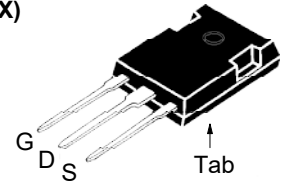
N-Channel Enhancement Mode
 Guaranteed FBSOA



TO-264
(IXTK)



PLUS247
(IXTX)



G = Gate D = Drain
 S = Source Tab = Drain

Symbol	Test Conditions	Maximum Ratings	
V _{DSS}	T _J = 25°C to 150°C	1500	V
V _{DGR}	T _J = 25°C to 150°C, R _{GS} = 1MΩ	1500	V
V _{GSS}	Continuous	±30	V
V _{GSM}	Transient	±40	V
I _{D25}	T _C = 25°C	8	A
I _{DM}	T _C = 25°C, Pulse Width Limited by T _{JM}	20	A
P _D	T _C = 25°C	700	W
T _J		-55 to +150	°C
T _{JM}		150	°C
T _{stg}		-55 to +150	°C
T _L	Maximum Lead Temperature for Soldering 1.6 mm (0.062 in.) from Case for 10s	300	°C
M _d	Mounting Torque (TO-264)	1.13/10	Nm/lb.in
F _C	Mounting Force (PLUS247)	20..120 /4.5..27	N/lb
Weight	TO-264	10	g
	PLUS247	6	g

Features

- Designed for Linear Operations
- International Standard Packages
- Guaranteed FBSOA at 60°C
- Molding Epoxies Meet UL94 V-0 Flammability Classification

Applications

- Programmable Loads
- Current Regulators
- DC-DC Convertors
- Battery Chargers
- DC Choppers
- Temperature and Lighting Controls

Advantages

- Easy to Mount
- Space Savings
- High Power Density

Symbol	Test Conditions (T _J = 25°C, Unless Otherwise Specified)	Characteristic Values		
		Min.	Typ.	Max.
BV _{DSS}	V _{GS} = 0V, I _D = 1mA	1500		V
V _{GS(th)}	V _{DS} = V _{GS} , I _D = 250μA	5.0		V
I _{GSS}	V _{GS} = ±30V, V _{DS} = 0V			±200 nA
I _{DSS}	V _{DS} = V _{DSS} , V _{GS} = 0V T _J = 125°C			50 μA 3 mA
R _{DS(on)}	V _{GS} = 20V, I _D = 0.5 • I _{D25} , Note 1			3.6 Ω

Symbol	Test Conditions ($T_J = 25^\circ\text{C}$, Unless Otherwise Specified)	Characteristic Values		
		Min.	Typ.	Max.
g_{fs}	$V_{DS} = 50\text{V}$, $I_D = 0.5 \cdot I_{D25}$, Note 1	1.4	2.3	3.2 S
C_{iss}	$V_{GS} = 0\text{V}$, $V_{DS} = 25\text{V}$, $f = 1\text{MHz}$		8000	pF
C_{oss}			405	pF
C_{rss}			70	pF
$t_{d(on)}$	Resistive Switching Times $V_{GS} = 15\text{V}$, $V_{DS} = 0.5 \cdot V_{DSS}$, $I_D = 0.5 \cdot I_{D25}$ $R_G = 2\Omega$ (External)		36	ns
t_r			18	ns
$t_{d(off)}$			90	ns
t_f			95	ns
$Q_{g(on)}$	$V_{GS} = 15\text{V}$, $V_{DS} = 0.5 \cdot V_{DSS}$, $I_D = 0.5 \cdot I_{D25}$		250	nC
Q_{gs}			80	nC
Q_{gd}			116	nC
R_{thJC}		0.15	0.18 $^\circ\text{C/W}$	
R_{thCS}			$^\circ\text{C/W}$	

Safe Operating Area Specification

Symbol	Test Conditions	Characteristic Values		
		Min.	Typ.	Max.
SOA	$V_{DS} = 1\text{kV}$, $I_D = 0.5\text{A}$, $T_C = 60^\circ\text{C}$, $T_P = 3\text{s}$	500		W

Source-Drain Diode

Symbol	Test Conditions ($T_J = 25^\circ\text{C}$, Unless Otherwise Specified)	Characteristic Values		
		Min.	Typ.	Max.
I_S	$V_{GS} = 0\text{V}$			8 A
I_{SM}	Repetitive, Pulse Width Limited by T_{JM}			32 A
V_{SD}	$I_F = 8\text{A}$, $V_{GS} = 0\text{V}$, Note 1			1.2 V
t_{rr}	$I_F = I_S$, $-di/dt = 100\text{A}/\mu\text{s}$, $V_R = 100\text{V}$	1700		ns

Note: 1. Pulse Test, $t \leq 300\mu\text{s}$; Duty Cycle, $d \leq 2\%$.

Littelfuse reserves the right to change limits, test conditions, and dimensions.

IXYS MOSFETs and IGBTs are covered by one or more of the following U.S. patents:	4,835,592	4,931,844	5,049,961	5,237,481	6,162,665	6,404,065 B1	6,683,344	6,727,585	7,005,734 B2	7,157,338 B2
	4,860,072	5,017,508	5,063,307	5,381,025	6,259,123 B1	6,534,343	6,710,405 B2	6,759,692	7,063,975 B2	
	4,881,106	5,034,796	5,187,117	5,486,715	6,306,728 B1	6,583,505	6,710,463	6,771,478 B2	7,071,537	

Fig. 1. Extended Output Characteristics @ $T_J = 25^\circ\text{C}$

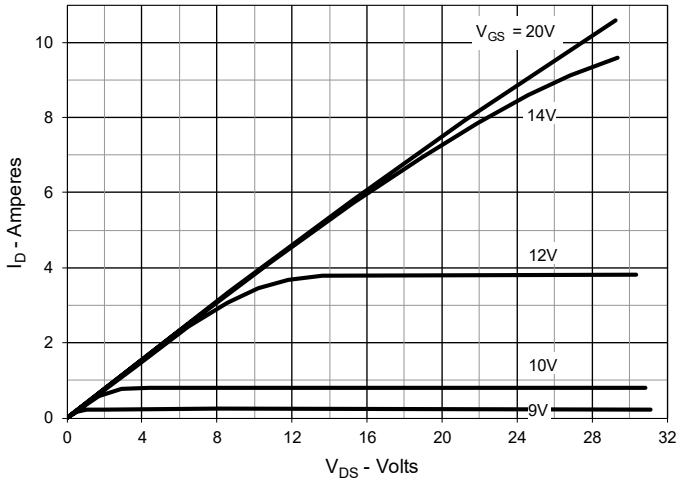


Fig. 2. Output Characteristics @ $T_J = 125^\circ\text{C}$

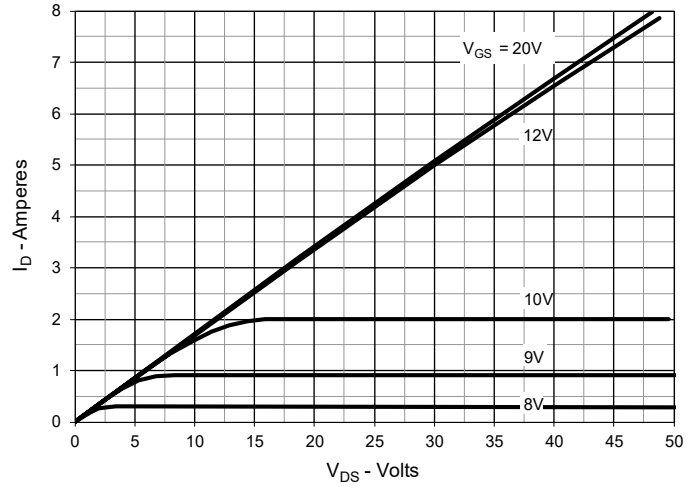


Fig. 3. $R_{DS(on)}$ Normalized to $I_D = 4\text{A}$ Value vs. Junction Temperature

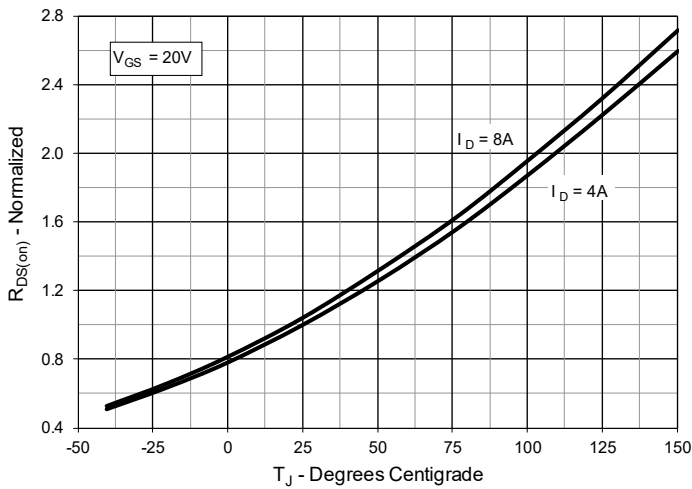


Fig. 4. $R_{DS(on)}$ Normalized to $I_D = 4\text{A}$ Value vs. Drain Current

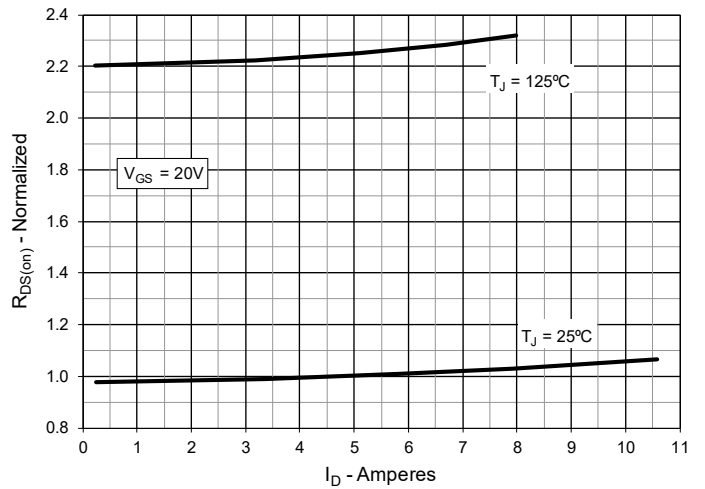


Fig. 5. Maximum Drain Current vs. Case Temperature

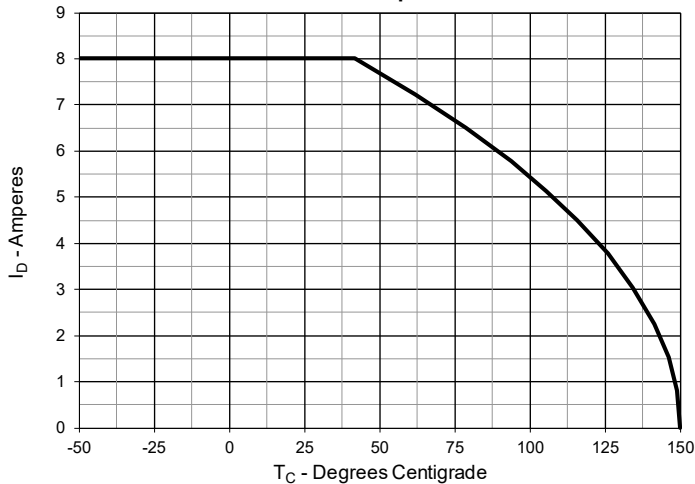


Fig. 6. Input Admittance

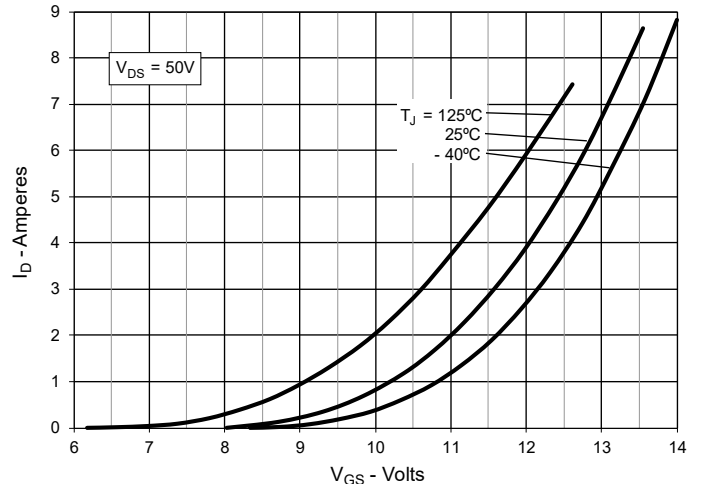


Fig. 7. Transconductance

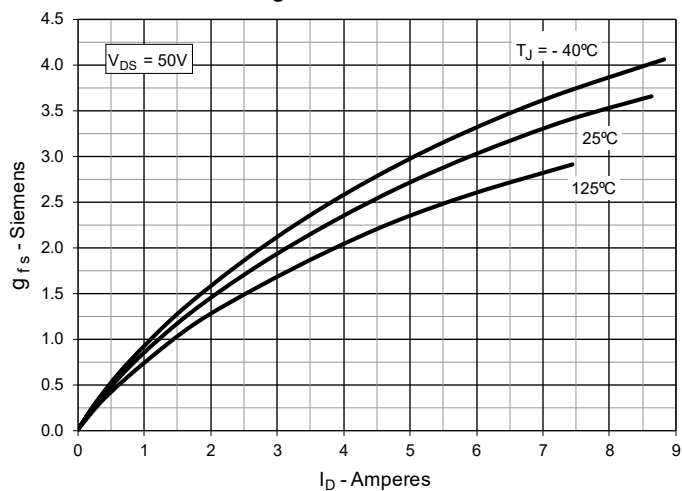


Fig. 8. Forward Voltage Drop of Intrinsic Diode

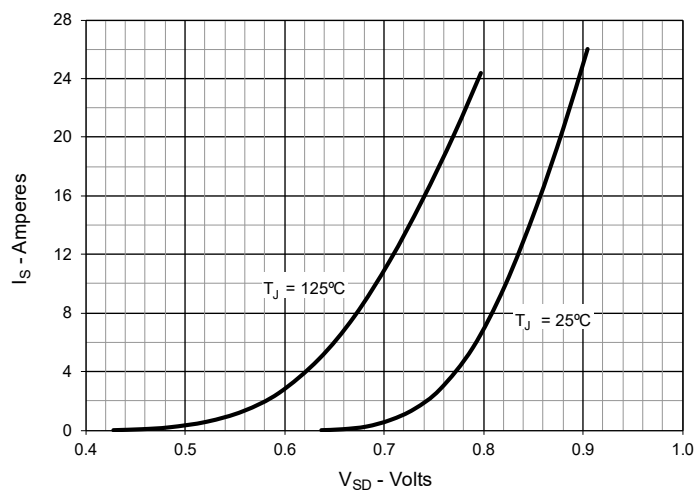


Fig. 9. Gate Charge

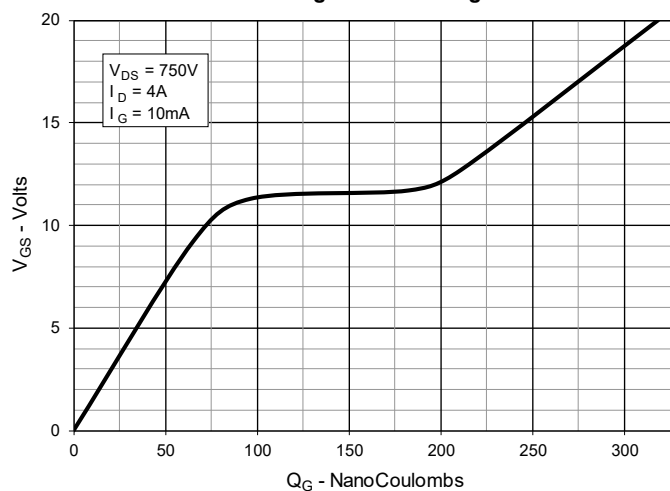


Fig. 10. Capacitance

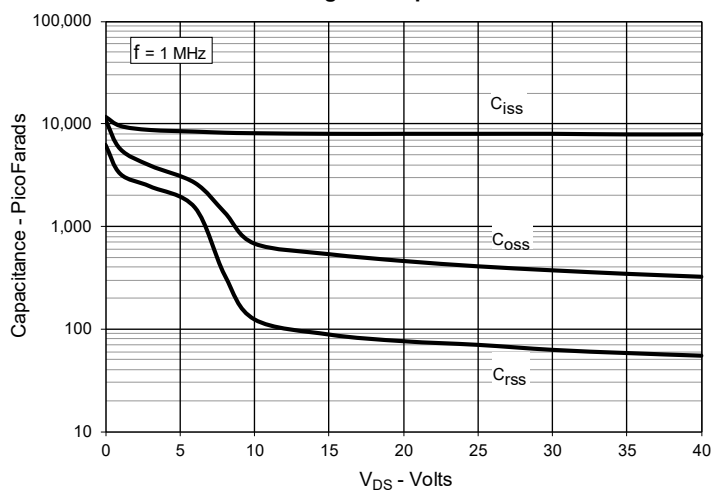
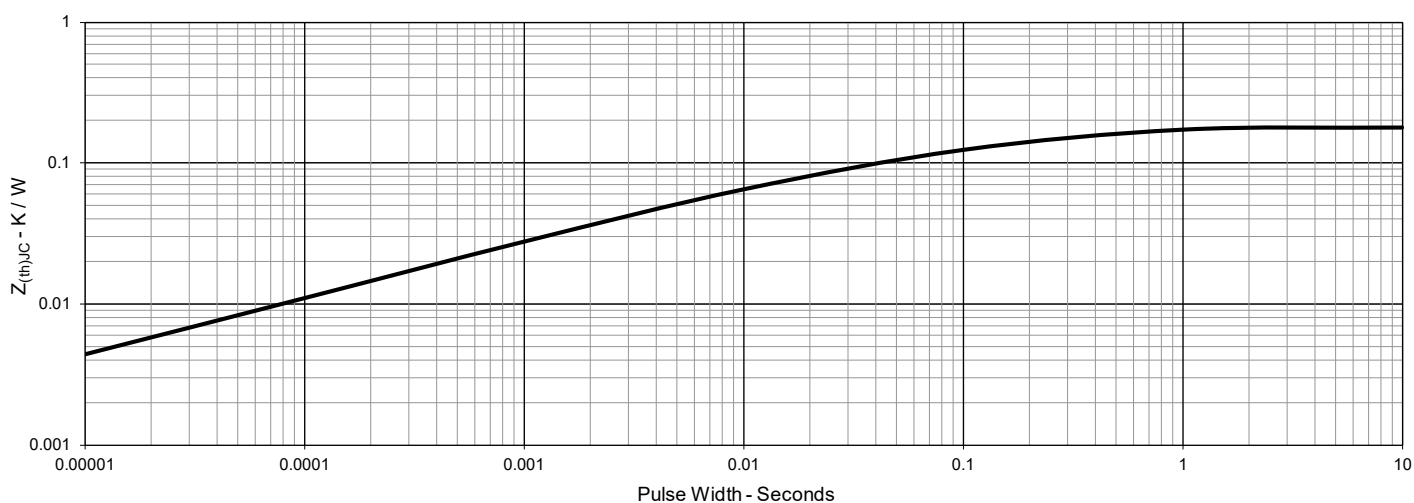
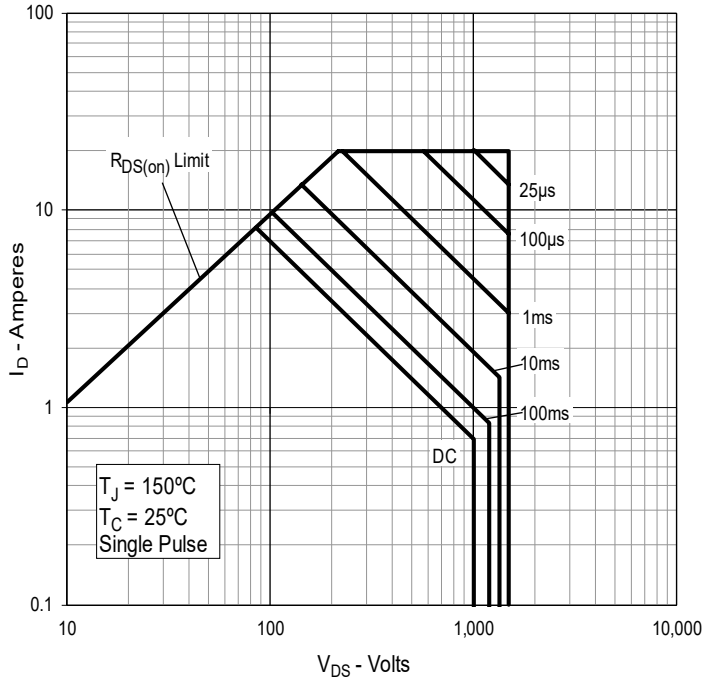


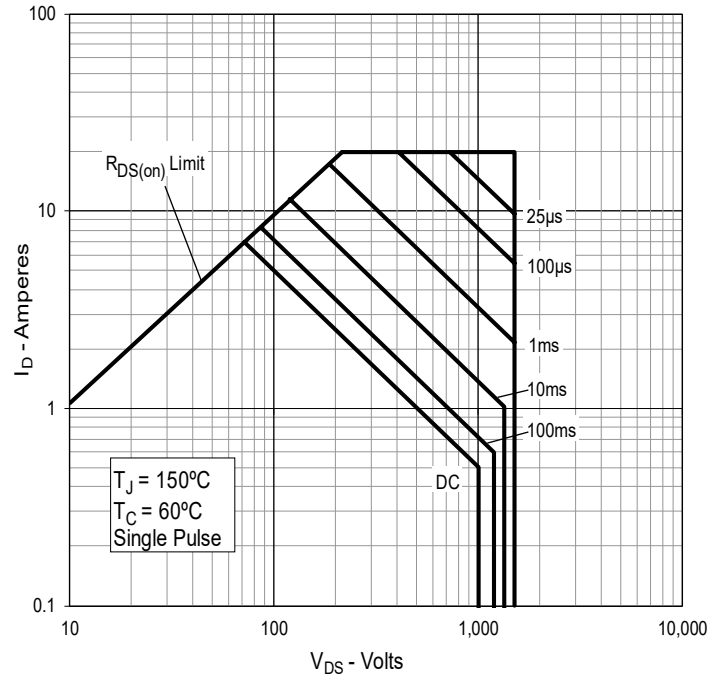
Fig. 11. Maximum Transient Thermal Impedance

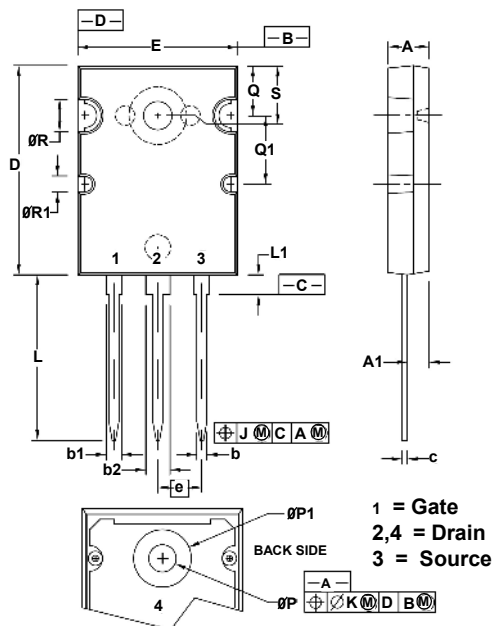


**Fig. 12. Forward-Bias Safe Operating Area
@ $T_C = 25^\circ\text{C}$**

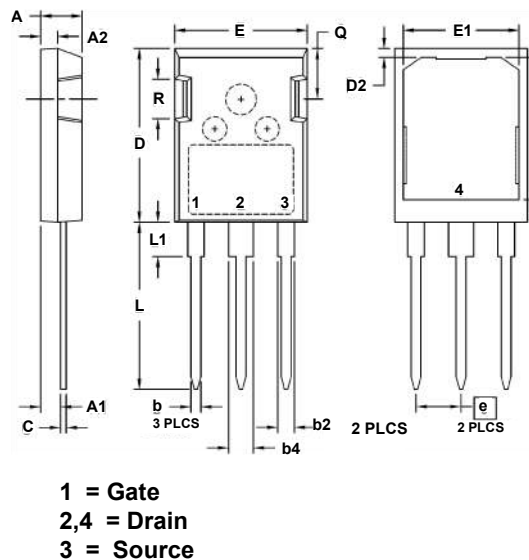


**Fig. 13. Forward-Bias Safe Operating Area
@ $T_C = 60^\circ\text{C}$**



TO-264 Outline


SYMBOL	INCHES		MILLIMETERS	
	MIN	MAX	MIN	MAX
A	.185	.209	4.70	5.31
A1	.102	.118	2.59	3.00
b	.037	.055	0.94	1.40
b1	.087	.102	2.21	2.59
b2	.110	.126	2.79	3.20
c	.017	.029	0.43	0.74
D	1.007	1.047	25.58	26.59
E	.760	.799	19.30	20.29
e	.215BSC		5.46 BSC	
J	.000	.010	0.00	0.25
K	.000	.010	0.00	0.25
L	.779	.842	19.79	21.39
L1	.087	.102	2.21	2.59
ØP	.122	.138	3.10	3.51
ØP1	.270	.290	6.86	7.37
Q	.240	.256	6.10	6.50
Q1	.330	.346	8.38	8.79
ØR	.155	.187	3.94	4.75
ØR1	.085	.093	2.16	2.36
S	.243	.253	6.17	6.43

PLUS247™ Outline


SYM	INCHES		MILLIMETERS	
	MIN	MAX	MIN	MAX
A	.190	.205	4.83	5.21
A1	.090	.100	2.29	2.54
A2	.075	.085	1.91	2.16
b	.045	.055	1.14	1.40
b2	.075	.087	1.91	2.20
b4	.115	.126	2.92	3.20
C	.024	.031	0.61	0.80
D	.819	.840	20.80	21.34
D1	.650	.690	16.51	17.53
D2	.035	.050	0.89	1.27
E	.620	.635	15.75	16.13
E1	.520	.560	13.08	14.22
e	.215 BSC		5.45 BSC	
L	.780	.810	19.81	20.57
L1	.150	.170	3.81	4.32
Q	.220	.244	5.59	6.20
R	.170	.190	4.32	4.83



Disclaimer Notice - Information furnished is believed to be accurate and reliable. However, users should independently evaluate the suitability of and test each product selected for their own applications. Littelfuse products are not designed for, and may not be used in, all applications. Read complete Disclaimer Notice at www.littelfuse.com/disclaimer-electronics.
