



PRODUCT SPECIFICATION

TABLE OF CONTENTS

- 1.0 SCOPE
- 2.0 PRODUCT DESCRIPTION
- 3.0 APPLICABLE DOCUMENTS AND SPECIFICATIONS
- 4.0 RATINGS
- 5.0 PERFORMANCE
- 6.0 PROCESSING GUIDELINES

1.0 SCOPE

This Product Specification covers the 1.0mm pitch board-to-board plug and receptacle connectors.

2.0 PRODUCT DESCRIPTION

2.1 The 71436 plug and the 71439 receptacle connectors have been designed in accordance with EIA standard 700 AAAB for 1.0mm two-part connectors for use with parallel printed boards.

2.1.1 All 1.0mm connectors are available with or without locating pegs.

2.1.2 All 1.0mm connectors can be supplied with a vacuum cap for robotic placement.

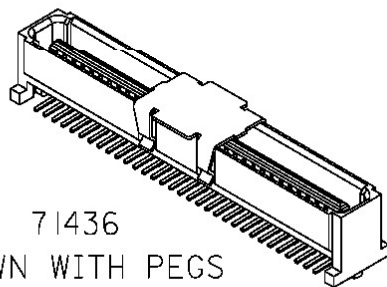

71436
SHOWN WITH PEGS
AND VACUUM CAP

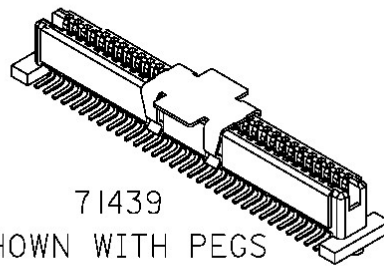

71439
SHOWN WITH PEGS
AND VACUUM CAP

REVISION: F	EGR/ECN INFORMATION: EC No: UCP2008-0856 DATE: 2007/10/15	TITLE: PRODUCT SPECIFICATION FOR 1.0mm BOARD-TO-BOARD CONNECTORS	SHEET No. 1 of 7
DOCUMENT NUMBER: PS-71436-9999	CREATED / REVISED BY: Marc Ibarra	CHECKED BY: Bob Barker	APPROVED BY: Steve Miller



PRODUCT SPECIFICATION

2.0 PRODUCT DESCRIPTION (CONT'D)

2.2 Product Name and Item Numbers
See figure 1 and table 1.

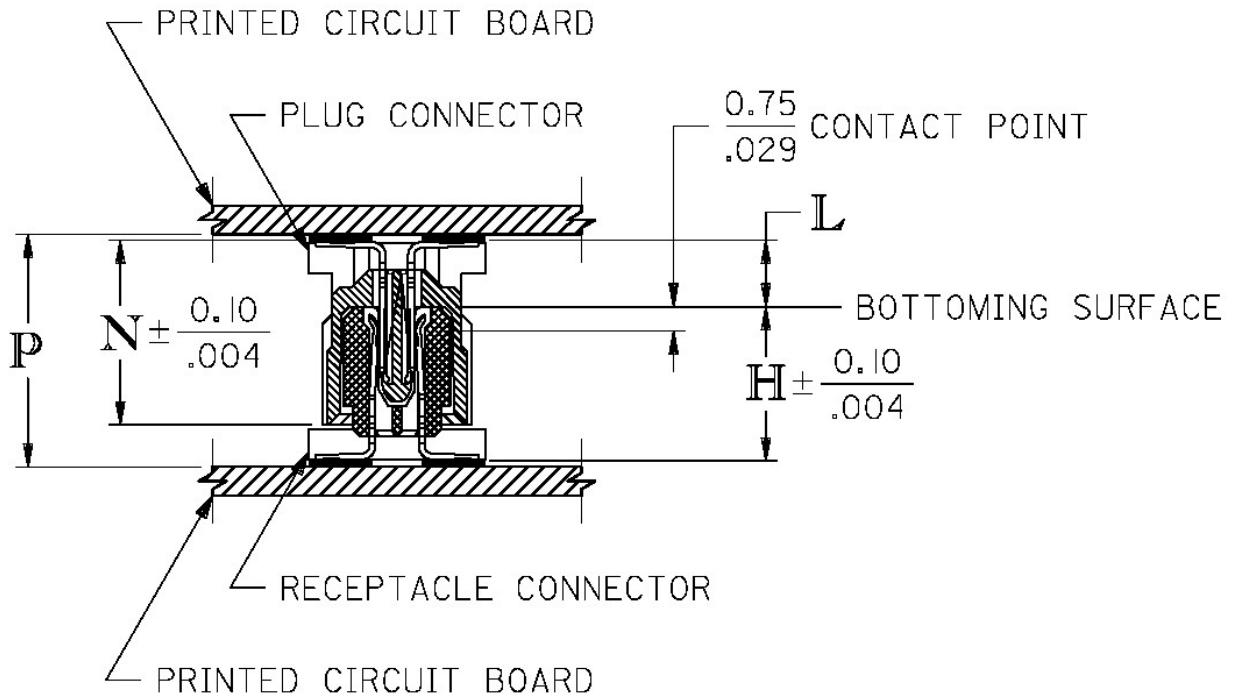

Figure 1

PLUG CONNECTOR			RECEPTACLE CONNECTOR		STACK HEIGHT DIMENSION P +0.00/-0.40 mm +.000/-0.16 Inch
ITEM NO.	DIM. N	DIM. L	ITEM NO.	DIM. H	
71436-0***	6.35/.250	2.30/.090	71439-0***	5.30/.209	8.00/.315
71436-1***	7.35/.289	3.30/.130	71439-0***	5.30/.209	9.00/.354
71436-2***	8.35/.329	4.30/.169	71439-0***	5.30/.209	10.00/.394
71436-1***	7.35/.289	3.30/.130	71439-1***	7.30/.287	11.00/.433
71436-2***	8.35/.329	4.30/.169	71439-1***	7.30/.287	12.00/.472
71436-2***	8.35/.329	4.30/.169	71439-2***	8.30/.327	13.00/.512
71436-1***	7.35/.289	3.30/.130	71439-3***	10.30/.406	14.00/.551
71436-2***	8.35/.329	4.30/.169	71439-3***	10.30/.406	15.00/.591

Table 1

REVISION: F	EGR/ECN INFORMATION: EC No: UCP2008-0856 DATE: 2007/10/15	TITLE: PRODUCT SPECIFICATION FOR 1.0mm BOARD-TO-BOARD CONNECTORS	SHEET No. 2 of 7
DOCUMENT NUMBER: PS-71436-9999	CREATED / REVISED BY: Marc Ibarra	CHECKED BY: Bob Barker	APPROVED BY: Steve Miller



PRODUCT SPECIFICATION

2.3 Dimensions, Materials, and Platings:

See appropriate sales drawings for information on dimensions, materials, and platings.

3.0 APPLICABLE DOCUMENTS AND SPECIFICATIONS

3.1 See sales drawings and other sections of this specification for necessary referenced documents and specifications.

3.2 Recognized Agency Approvals:

3.2.1 Underwriters Laboratories Inc.: File Number E29179

4.0 RATINGS

4.1 VOLTAGE

250Volts AC (RMS) (contact to contact)

4.2 CURRENT (30°C Temperature rise)

0.5 Amps maximum, all circuits wired in series ; 1.0 Amps maximum, five adjacent circuits wired in series

4.3 TEMPERATURE

Operating: - 55°C to + 85°C

5.0 PERFORMANCE

5.1 ELECTRICAL REQUIREMENTS

ITEM	DESCRIPTION	TEST CONDITION	REQUIREMENT
1	Contact Resistance (Low Level)	Mate connectors, measure by dry circuit: apply a maximum voltage of 20 mV and a current of 10 mA.	30 milliohms MAXIMUM [initial]
2	Contact Resistance @ Rated Current	Mate connectors: apply a maximum voltage of 20 mV at rated current.	15 milliohms MAXIMUM [initial]
3	Insulation Resistance	Apply 250±50 VDC, measure resistance between adjacent terminals.	100 megaohms MINIMUM
4	Dielectric Withstanding Voltage	Apply 250VAC for 1 minute between adjacent terminals.	No breakdown;

REVISION: F	EGR/ECN INFORMATION: EC No: UCP2008-0856 DATE: 2007/10/15	TITLE: PRODUCT SPECIFICATION FOR 1.0mm BOARD-TO-BOARD CONNECTORS	SHEET No. 3 of 7
DOCUMENT NUMBER: PS-71436-9999		CREATED / REVISED BY: Marc Ibarra	CHECKED BY: Bob Barker
		APPROVED BY: Steve Miller	



PRODUCT SPECIFICATION

5.2 MECHANICAL REQUIREMENTS

ITEM	DESCRIPTION	TEST CONDITION	REQUIREMENT
5	Terminal Retention Force	Apply axial force on terminal in housing at rate of 25±6mm (1 ± ¼ inch) per minute.	3.9 N (0.4 Kgf) MINIMUM retention force
6	Connector Mate and Unmate Forces	Mate and unmate connectors (male to female) at a rate of 25 ± 6 mm (1 ± ¼ inch) per minute.	Mate Force: 60g X no. of circuits maximum & Un-Mate Force: 23g X no. of circuits, minimum
7	Durability	Mate connectors up to 100 cycles at a maximum rate of 10mm (0.40in) per second; rest 30 seconds minimum (when unmated).	Maximum contact resistance change: 15 milliohms
8	Vibration (Random)	Amplitude: 1.9mm (.076in) peak-to-peak; Sweep: 10-55-10 Hz in one minute; Duration: 2 hours in each axis x, y and z.	Maximum contact resistance change: 15 milliohms & Discontinuity < 1 microsecond
10	Shock (Mechanical)	490 m/s ² (50g) peak saw-tooth, 11 milliseconds duration; one shock each direction in each axis x, y and z.	Maximum contact resistance change: 15 milliohms & Discontinuity < 1 microsecond

5.3 ENVIRONMENTAL REQUIREMENTS

ITEM	DESCRIPTION	TEST CONDITION	REQUIREMENT						
11	Shock (Thermal)	Mate connectors; expose to 5 cycles of: <table border="1"> <tr> <td><u>Temperature °C</u></td> <td><u>Duration (Minutes)</u></td> </tr> <tr> <td>-40 +0/-3</td> <td>30</td> </tr> <tr> <td>+105 +3/-0</td> <td>30</td> </tr> </table>	<u>Temperature °C</u>	<u>Duration (Minutes)</u>	-40 +0/-3	30	+105 +3/-0	30	Maximum contact resistance change: 15 milliohms & Visual: No Damage
<u>Temperature °C</u>	<u>Duration (Minutes)</u>								
-40 +0/-3	30								
+105 +3/-0	30								
12	Thermal Aging	Mate connectors; expose to: 250 hours at 85 ± 2°C	Maximum contact resistance change: 15 milliohms & Visual: No Damage						

REVISION: F	EGR/ECN INFORMATION: EC No: UCP2008-0856 DATE: 2007/10/15	TITLE: PRODUCT SPECIFICATION FOR 1.0mm BOARD-TO-BOARD CONNECTORS	SHEET No. 4 of 7
DOCUMENT NUMBER: PS-71436-9999	CREATED / REVISED BY: Marc Ibarra	CHECKED BY: Bob Barker	APPROVED BY: Steve Miller



PRODUCT SPECIFICATION

5.3 ENVIRONMENTAL REQUIREMENTS (continued)

ITEM	DESCRIPTION	TEST CONDITION	REQUIREMENT
27	Humidity (Steady State)	Mate connectors: expose to a temperature of $40 \pm 2^{\circ}\text{C}$ with a relative humidity of 90-95% for 240 hours. Per MIL-STD-202F, Method 103B, Test Condition A.	Maximum contact resistance change: 15 milliohms & Visual: No Damage
28	Humidity (Cyclic)	Test mated connectors per MIL-STD-202F, Method 106E, excluding steps 7a and 7b.	Maximum contact resistance change: 15 milliohms & Visual: No Damage
30	Temperature Rise and Current Cycling	Measure Temperature rise of mated connectors at rated current after 96 hours, then after 45 minutes ON, 15 minutes OFF for 240 hours, and finally after 96 hours at rated current.	Maximum Temperature rise: 30°C over ambient Maximum contact resistance change: 15 milliohms
36	Mixed Flowing Gas	Environmental Class II, 7 days unmated.	Maximum contact resistance change: 15 milliohms

6.0 PROCESSING GUIDELINES

<u>PROCESSING STEPS</u>	<u>RECOMMENDATION</u>	<u>COMMENTS</u>
Resistance to Soldering Heat	Peak soldering temperature to be 265 degrees C. Maximum time within 5 degrees of peak temperature to be 40 seconds. Note: Connectors must be dried for 8 hours @ 70°C prior to processing at temperatures over 245°C . Connectors may be left in the tape and reel or tubes during the drying operation.	Appearance: No Physical Damage

REVISION: F	EGR/ECN INFORMATION: EC No: UCP2008-0856 DATE: 2007/10/15	TITLE: PRODUCT SPECIFICATION FOR 1.0mm BOARD-TO-BOARD CONNECTORS	SHEET No. 5 of 7
DOCUMENT NUMBER: PS-71436-9999	CREATED / REVISED BY: Marc Ibarra	CHECKED BY: Bob Barker	APPROVED BY: Steve Miller



PRODUCT SPECIFICATION

MATED ENVIRONMENTAL
AND MECHANICAL

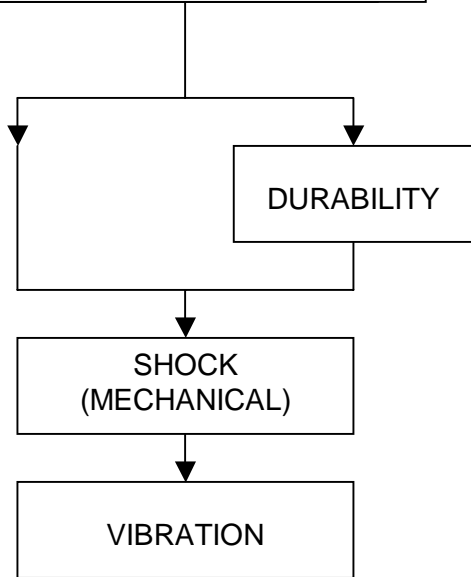

MATED ENVIRONMENTAL

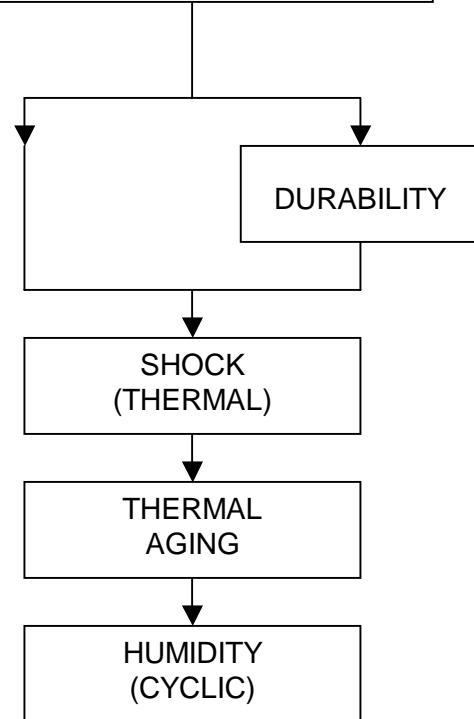

REVISION: F	EGR/ECN INFORMATION: EC No: UCP2008-0856 DATE: 2007/10/15	TITLE: PRODUCT SPECIFICATION FOR 1.0mm BOARD-TO-BOARD CONNECTORS	SHEET No. 6 of 7
DOCUMENT NUMBER: PS-71436-9999	CREATED / REVISED BY: Marc Ibarra	CHECKED BY: Bob Barker	APPROVED BY: Steve Miller



PRODUCT SPECIFICATION

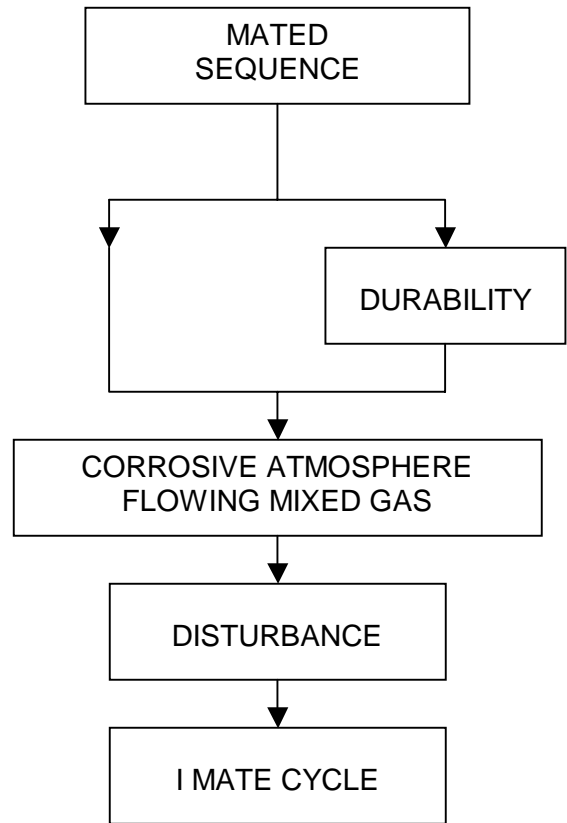
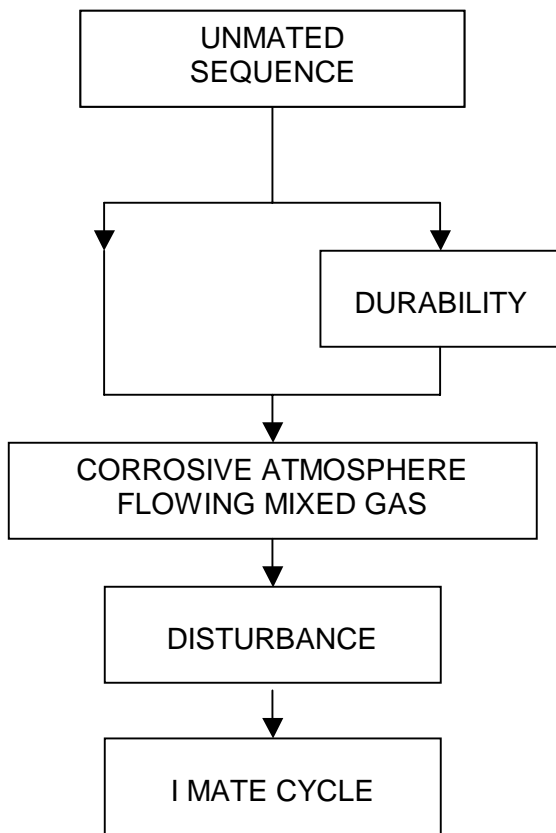

REVISION: F	EGR/ECN INFORMATION: EC No: UCP2008-0856 DATE: 2007/10/15	TITLE: PRODUCT SPECIFICATION FOR 1.0mm BOARD-TO-BOARD CONNECTORS	SHEET No. 7 of 7
DOCUMENT NUMBER: PS-71436-9999	CREATED / REVISED BY: Marc Ibarra	CHECKED BY: Bob Barker	APPROVED BY: Steve Miller