



# FOCUS LCDs

LCDs MADE SIMPLE®

Ph. 480-503-4295 | [NOPP@FocusLCDs.com](mailto:NOPP@FocusLCDs.com)

TFT | OLED | CHARACTER | GRAPHIC | UWVD | SEGMENT | CUSTOM

## TFT Display Module

Part Number

E50GB-RW800-R

### Overview:

- 5.0-inch TFT (120.7x75.8mm)
- 800x400 Pixels
- RGB Interface
- Wide Temp Range
- 12:00 Viewing Angle
- Transmissive, Normally White
- Resistive Touch Panel
- 800 NITS
- TFT IC: ILI6122 / ILI5960
- RoHS Compliant

## Description

This is a color active matrix TFT (Thin Film Transistor) LCD (Liquid Crystal Display) that uses amorphous silicon TFT as a switching device. This model is composed of a transmissive type TFT-LCD panel, driver circuit, resistive touch panel, and backlight unit. The resolution of the 5.0" TFT-LCD contains 800x480 pixels and can display up to 16.7M colors.

## Features

Input Voltage: 3.3V

TFT Interface: 24-Bit RGB

General Information Items	Specification	Unit
	Main Panel	
TFT Display Area (AA)	108 (H) x 64.8 (V) (5.0-Inch)	mm
Driver Element	TFT Active Matrix	--
Display Colors	16.7M	Colors
Number of Pixels	800(RGB)x480	Dots
TFT Pixel Arrangement	RGB Vertical Stripe	--
Viewing Angle	12:00	O'clock
TFT IC	ILI6122 / ILI5960	--
Display Mode	Transmissive / Normally White	--
Operating Temperature	-20 to +70	°C
Storage Temperature	-30 to +80	°C

## Mechanical Information

Item		Min.	Typ.	Max.	Unit
Module Size	Horizontal (H)	--	120.7	--	mm
	Vertical (V)	--	75.8	--	mm
	Depth (D)	--	4.15	--	mm
Weight		--	TBD	--	g

# 1. Outline Dimensions

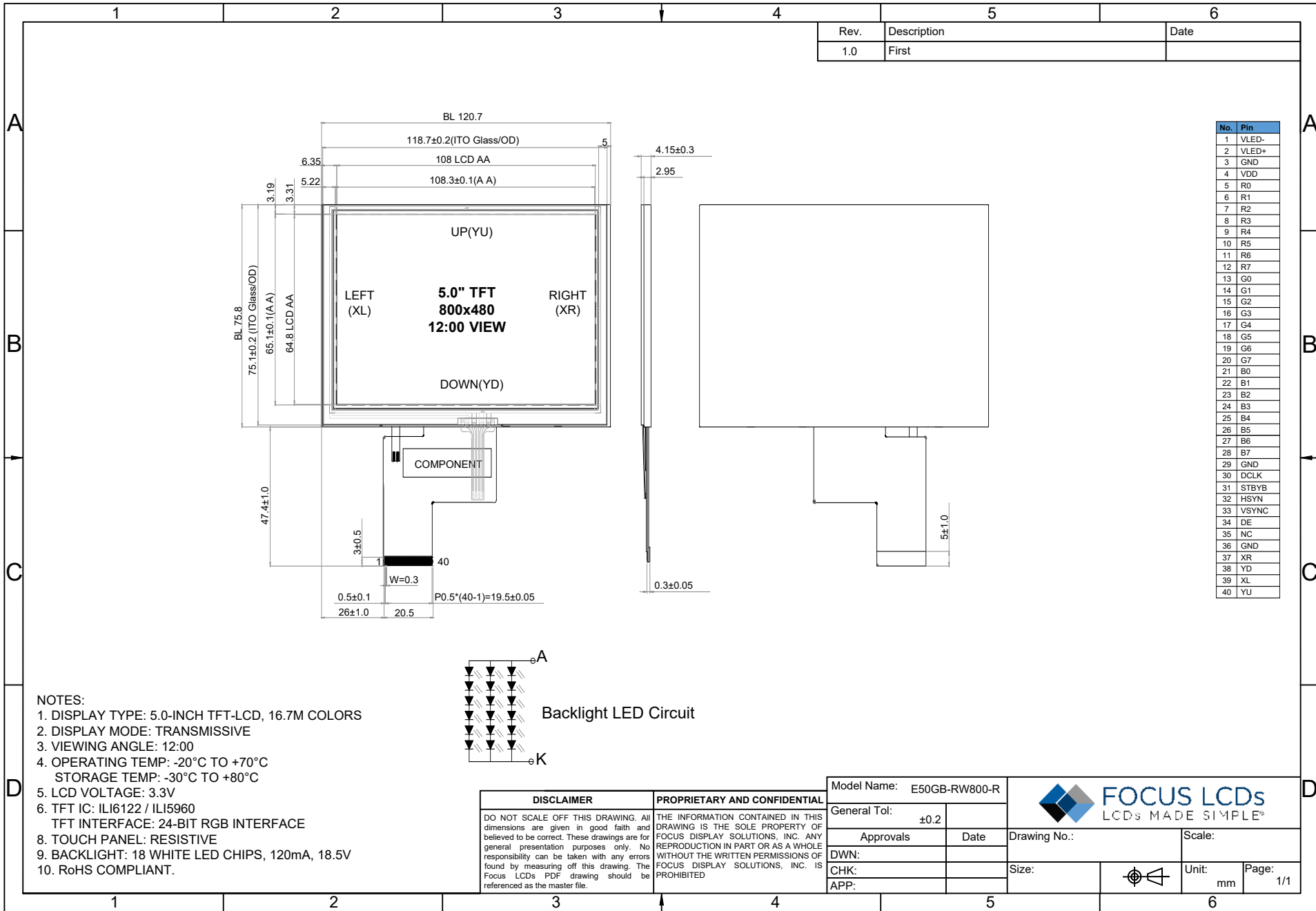

## 2. Input Terminal Pin Assignment

### 2.1 TFT Pin Assignment

Recommended TFT Connector: FH12S-40S-0.5SH(55)

NO.	Symbol	Description	I/O
1	VLED-	Power for backlight (Ground)	P
2	VLED+	Power for backlight (Anode)	P
3	GND	Ground	P
4	VDD	Power Supply	P
5	R0	Red Data	I/O
6	R1	Red Data	I/O
7	R2	Red Data	I/O
8	R3	Red Data	I/O
9	R4	Red Data	I/O
10	R5	Red Data	I/O
11	R6	Red Data	I/O
12	R7	Red Data	I/O
13	G0	Green Data	I/O
14	G1	Green Data	I/O
15	G2	Green Data	I/O
16	G3	Green Data	I/O
17	G4	Green Data	I/O
18	G5	Green Data	I/O
19	G6	Green Data	I/O
20	G7	Green Data	I/O
21	B0	Blue Data	I/O
22	B1	Blue Data	I/O
23	B2	Blue Data	I/O
24	B3	Blue Data	I/O
25	B4	Blue Data	I/O
26	B5	Blue Data	I/O
27	B6	Blue Data	I/O

28	B7	Blue Data	I/O
29	GND	Ground	P
30	DCLK	Dot clock signal for RGB interface operation.	I
31	DISP	Display ON / OFF	I
32	HSYNC	Line synchronous signal for RGB interface operation	I
33	VSYNC	Frame synchronous signal for RGB interface operation	I
34	DE	Data enable signal for RGB interface operation	I
35	NC	No connect	-
36	GND	Ground	P
37	XR	TP electrode for right	-
38	YD	TP electrode for down	-
39	XL	TP electrode for left	-
40	YU	TP electrode for up	-

I: Input, P: Power, O: Output

### 3. LCD Optical Characteristics

#### 3.1 Optical Specifications

Item	Symbol	Condition	Min.	Typ.	Max.	Unit	Note	
Contrast Ratio	CR	$\Theta = 0$ Normal Viewing Angle	300	350	--	%	(2)	
Response Time	Rising		$T_R$	--	3	6	ms	(4)
	Falling		$T_F$	--	7	14		
Color Filter Chromaticity	White		$W_X$	0.25	0.30	0.35		(5)(6)
		$W_Y$	0.27	0.32	0.37			
Viewing Angle	Hor.	$\Theta_L$	65	75	--	Degree	(1)(6)	
		$\Theta_R$	65	75	--			
	Ver.	$\Theta_T$	50	60	--			
		$\Theta_B$	60	70	--			

## Optical Specification Reference Notes:

### (1) Definition of Viewing Angle:

The viewing angle is the angle at which the contrast ratio is greater than 10. The viewing angles are determined for the horizontal or 3,9 o'clock direction and the vertical or 6,12 o'clock direction with respect to the optical axis which is normal to the LCD surface.

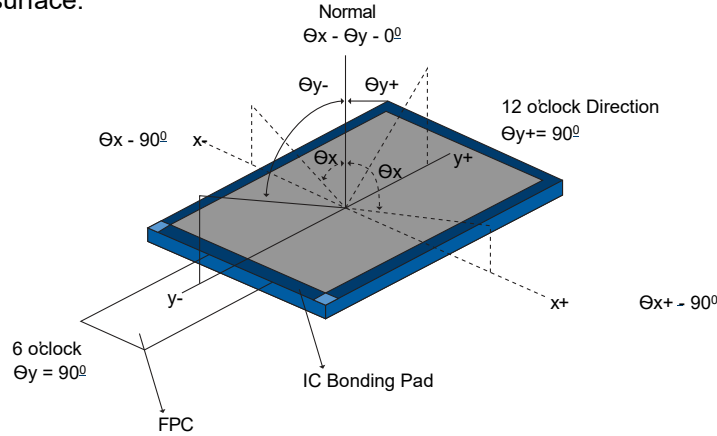

### (2) Definition of Contrast Ratio:

Measured at the center point of panel. The contrast ratio (Cr) measured on a module, is the ratio between the luminance (Lw) in a full white area (R=G=B=1) and the luminance (Ld) in a dark area (R=G=B=0).

$$Cr = \frac{Lw}{Ld}$$

### (3) Definition of Transmittance (T%):

The transmittance of the panel including the polarizers is measured with electrical driving. The equation for transmittance Tr is:

$$Tr = \frac{It}{Io} \times 100\%$$

$Io$  = the brightness of the light source.

$It$  = the brightness after panel transmission

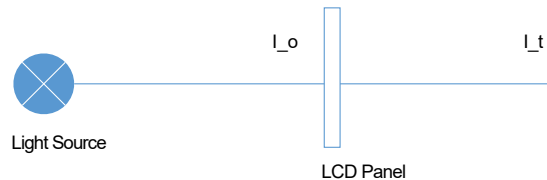

### (4) Definition of Response Time (TR, TF):

The rise time 'Tr' is defined as the time for luminance to change from 90% to 10% as a result of a change of the electrical condition. The fall time 'Tf' is defined as the time for luminance to change from 10% to 90% as a result of a change of the electrical condition.

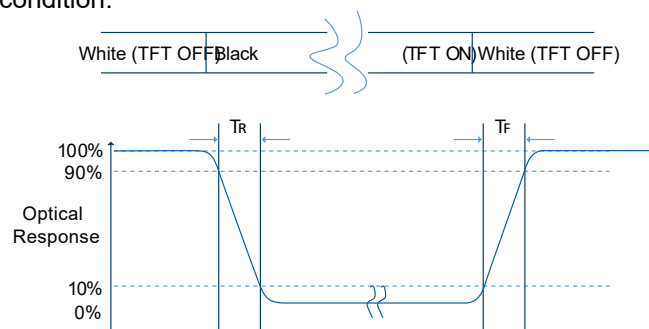

**(5) Definition of Color Gamut:**

Measuring machine CFT-01. NTSC's Primaries: R(x,y,Y),G(x,y,Y), B(x,y,Y). FPM520 of Westar Display Technologies, INC., which utilized SR-3 for Chromaticity and BM-5A for other optical characteristics. The color chromaticity shall be calculated from the spectral data measured with all pixels first in red, green, blue and white. Measurements shall be made at the center of the panel.

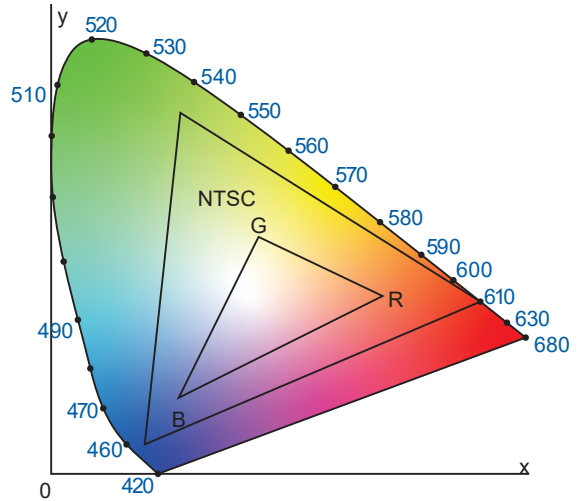
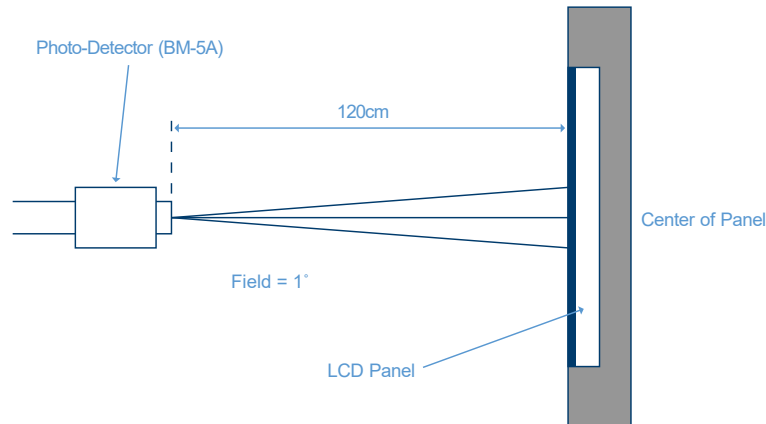
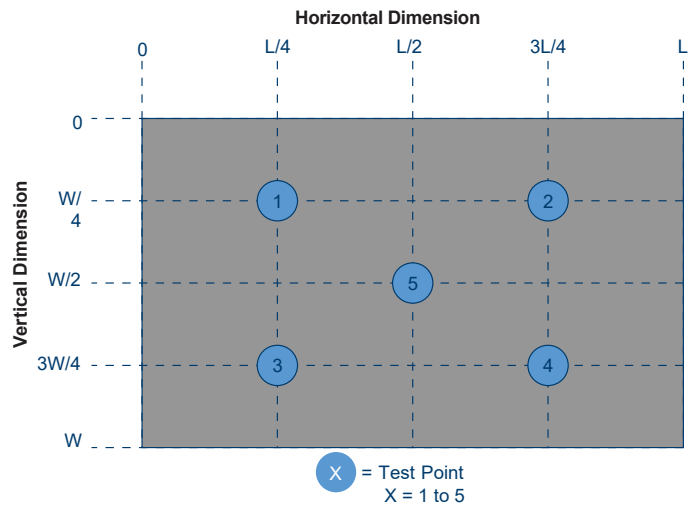
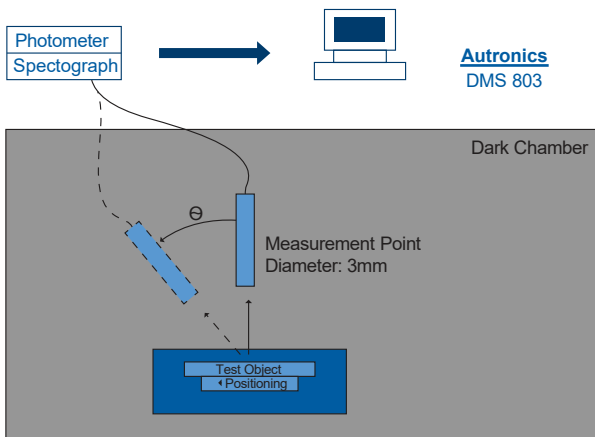

Fig. 1931 CIE Chromacity Diagram

Color Gamut:  $S = \frac{\text{Area of RGB Triangle}}{\text{Area of NTSC Triangle}} \times 100\%$

**(6) Definition of Optical Measurement Setup:**

The LCD module should be stabilized at a given temperature for 20 minutes to avoid abrupt temperature change during measuring. In order to stabilize the luminance, the measurement should be executed after lighting backlight for 20 minutes.



## 4. TFT Electrical Characteristics

### 4.1 Absolute Maximum Ratings (Ta=25±2°C, VSS=GND=0V)

Characteristics	Symbol	Min.	Max.	Unit
Digital Supply Voltage	VDD	VSS-0.3	5.0	V
Operating Temperature	TOP	-20	70	°C
Storage Temperature	TST	-30	80	°C

*NOTE: If the absolute maximum rating of the above parameters is exceeded, even momentarily, the quality of the product may be degraded. Absolute maximum ratings specify the values which the product may be physically damaged if exceeded. Be sure to use the product within the range of the absolute maximum ratings.*

### 4.2 LED Backlight Characteristics

This module utilizes an edge-lit backlight system with 18 LED chips.

Item	Symbol	Min.	Typ.	Max.	Unit	Note
Forward Current	I <sub>F</sub>	--	120	--	mA	
Forward Voltage	V <sub>F</sub>	16.2	--	19.8	V	
LCM Luminance	L <sub>v</sub>	650	800	--	cd/m <sup>2</sup>	(1)
Uniformity	Avg	70	80	--	%	(1)

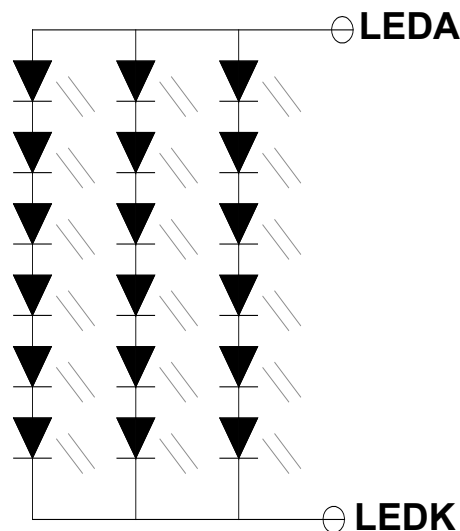

**BL CIRCUIT DIAGRAM**



**Note 1:** Luminance Uniformity of these 9 points is defined as below:

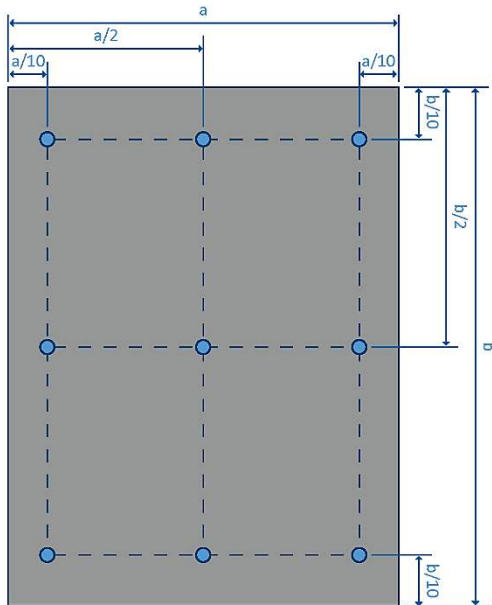

$$\text{Luminance} = \frac{\text{Total Luminance of 9 Points}}{9}$$

$$\text{Uniformity} = \frac{\text{Minimum Luminance in 9 Points(1-9)}}{\text{Maximum Luminance in 9 Points(1-9)}}$$

## 5. TFT AC Characteristics

For further details and configurations, please see the spec for IC [ILI6122](#) and [ILI5960](#).

### 5.1 Parallel 24-Bit RGB Mode

Note: VDD=2.7V ~ 3.6V, AVDD=6.5V ~ 13.5V, GND=AGND=0V, Ta=-20 ~ +80°C

Parameter	Symbol	Min.	Typ.	Max.	Unit	Conditions
CLKIN Frequency	Fclk	--	33	50	MHz	VDD=2.7V ~ 3.6V
CLKIN Cycle Time	Tclk	20	30	--	Ns	
CLKIN Pulse Duty	Tcwh	40	50	60	%	Tclk
Time from HSD to Source Output	Thso	--	64	--	CLKIN	
Time from HSD to LD	Thld	--	64	--	CLKIN	
Time from HSD to STV	Thstve	--	2	--	CLKIN	
Time from HSD to CKV	Thckv	--	20	--	CLKIN	
Time from HSD to OEV	Thoev	--	4	--	CLKIN	
LD Pulse Width	Twld	--	10	--	CLKIN	
CKV Pulse Width	Twckv	--	66	--	CLKIN	
OEV Pulse Width	Twoev	--	92	--	CLKIN	

## 5.2 Input Clock and Data Timing

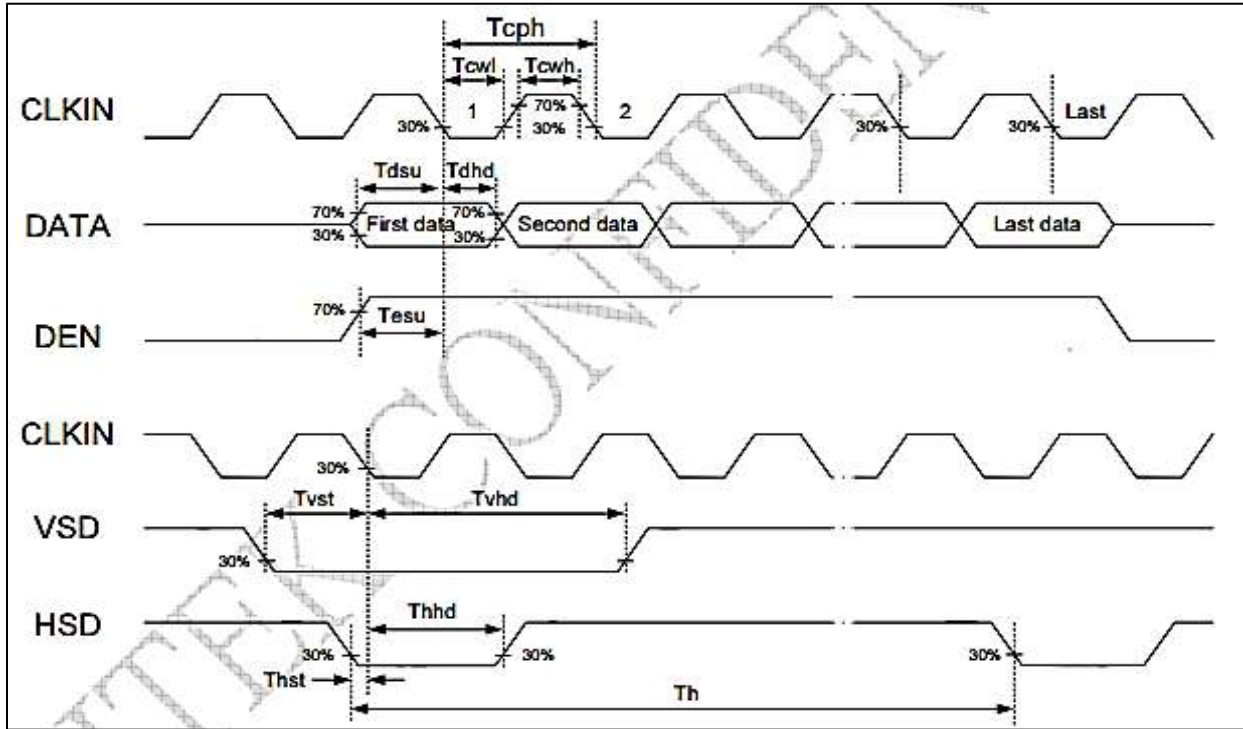

*Input Clock and Data Timing*

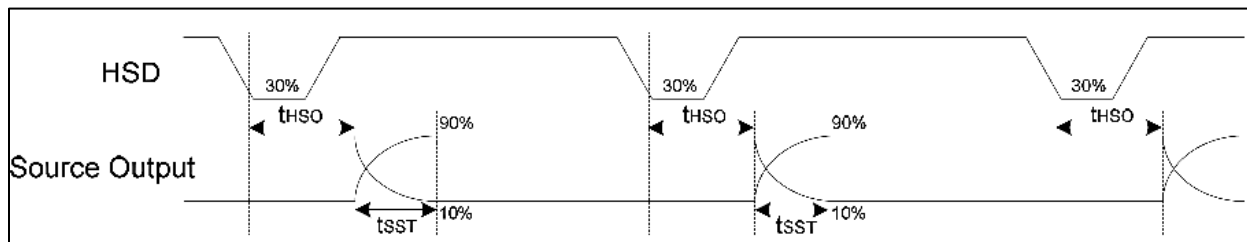

*Source Output Timing Diagram*

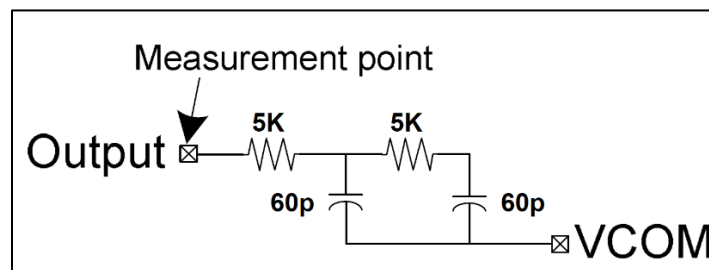

*Output Loading Condition*

### 5.3 Vertical Timing Diagram of HV Mode (Dual Gate)

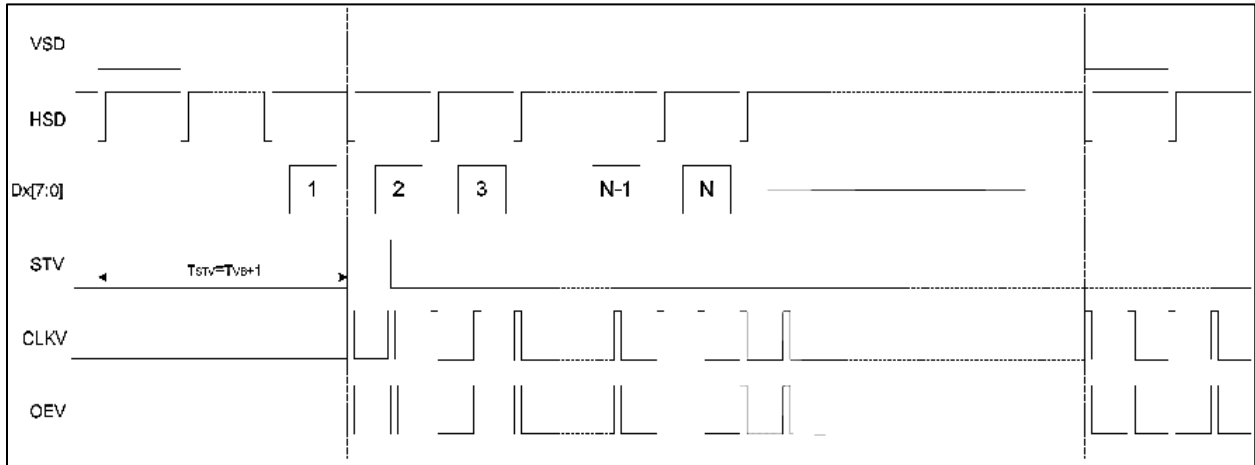

### 5.4 Vertical Timing Diagram of DE Mode (Dual Gate)

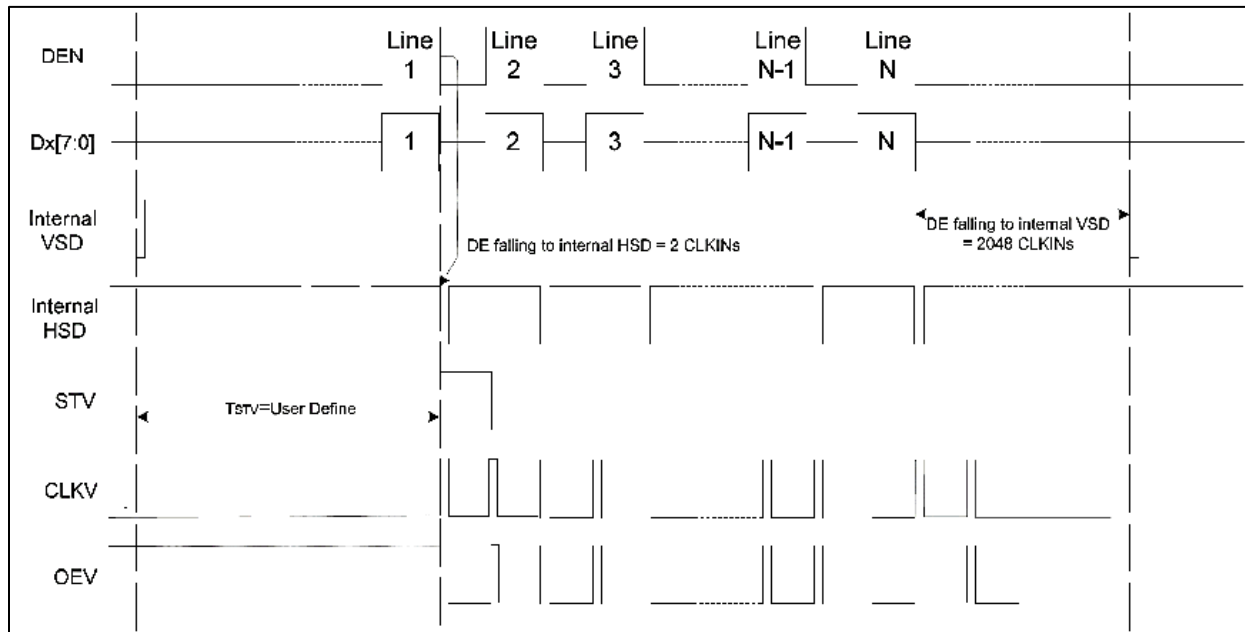

## 5.5 Gate Output Timing Diagram (Dual Gate)

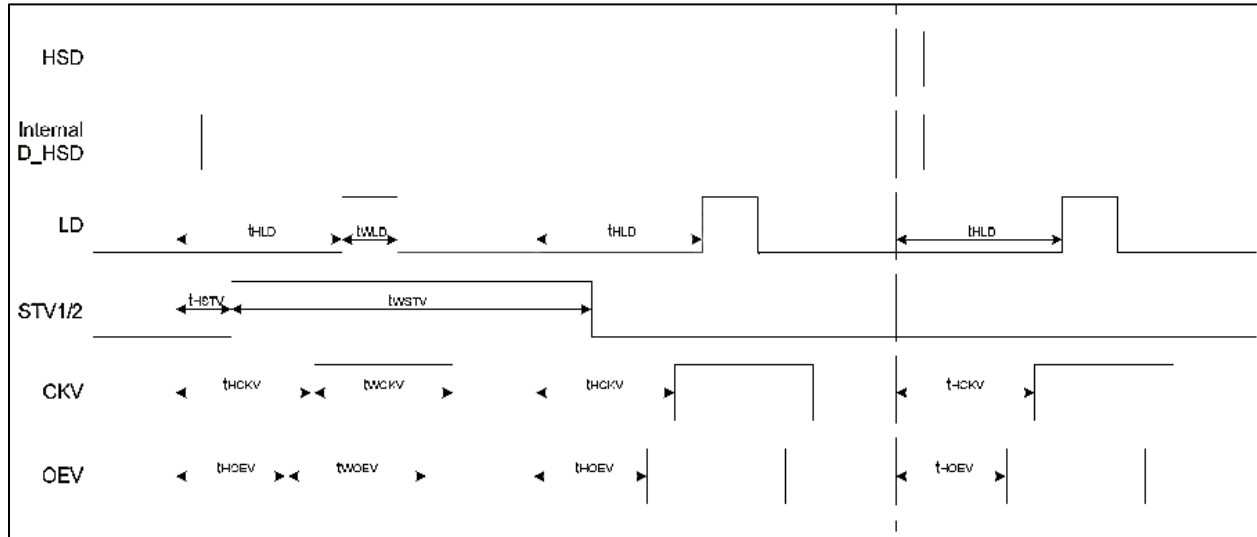

## 5.6 SPI Timing

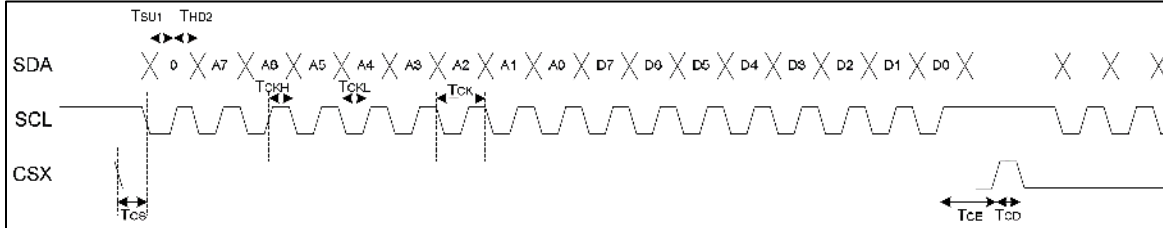

Parameter	Symbol	Specifications			Unit
		Min.	Typ.	Max.	
SCL Period	$T_{CK}$	60	--	--	Ns
SCL High Width	$T_{CKH}$	30	--	--	Ns
SCL Low Width	$T_{CKL}$	30	--	--	Ns
Data Setup Time	$T_{SU1}$	12	--	--	Ns
Data Hold Time	$T_{HD1}$	12	--	--	Ns
CSB to SCL Setup Time	$T_{CS}$	20	--	--	Ns
CSB to SDA Hold Time	$T_{CE}$	20	--	--	Ns
CSB High Pulse Width	$T_{CD}$	50	--	--	Ns

## 6. Quality Inspection Standards

For TFT quality inspection standards, please see the following link: <https://focuslcds.com/tft-quality-inspectionstandards/>

## 7. Cautions and Handling Precautions

### 7.1 Handling and Operating the Module

1. When the module is assembled, it should be attached to the system firmly. Do not warp or twist the module during assembly work.
2. Protect the module from physical shock or any force. In addition to damage, this may cause improper operation or damage to the module and back-light unit.
3. Note that polarizer is very fragile and could be easily damaged. Do not press or scratch the surface.
4. Do not allow drops of water or chemicals to remain on the display surface. If you have the droplets for a long time, staining and discoloration may occur.
5. If the surface of the polarizer is dirty, clean it using some absorbent cotton or soft cloth.
6. The desirable cleaners are water, IPA (Isopropyl Alcohol) or Hexane. Do not use ketene type materials (ex. Acetone), Ethyl alcohol, Toluene, Ethyl acid or Methyl chloride. It might permanent damage to the polarizer due to chemical reaction.
7. If the liquid crystal material leaks from the panel, it should be kept away from the eyes or mouth. In case of contact with hands, legs, or clothes, it must be washed away thoroughly with soap.
8. Protect the module from static; it may cause damage to the CMOS ICs.
9. Use fingerstalls with soft gloves in order to keep display clean during the incoming inspection and assembly process.
10. Do not disassemble the module.
11. Protection film for polarizer on the module shall be slowly peeled off just before use so that the electrostatic charge can be minimized.
12. Pins of I/F connector shall not be touched directly with bare hands.
13. Do not connect, disconnect the module in the "Power ON" condition.
14. Power supply should always be turned on/off by the item Power On Sequence & Power Off Sequence.

### 7.2 Storage and Transportation

1. Do not leave the panel in high temperature, and high humidity for a long time. It is highly recommended to store the module with temperature from 0 to 35 °C and relative humidity of less than 70%
2. Do not store the TFT-LCD module in direct sunlight.
3. The module shall be stored in a dark place. When storing the modules for a long time, be sure to adopt effective measures for protecting the modules from strong ultraviolet radiation, sunlight, or fluorescent light.
4. It is recommended that the modules should be stored under a condition where no condensation is allowed. Formation of dewdrops may cause an abnormal operation or a failure of the module. In particular, the greatest possible care should be taken to prevent any module from being operated where condensation has occurred inside.
5. This panel has its circuitry FPC on the bottom side and should be handled carefully in order not to be stressed.