

**RECOMMENDED PCB LAYOUT**

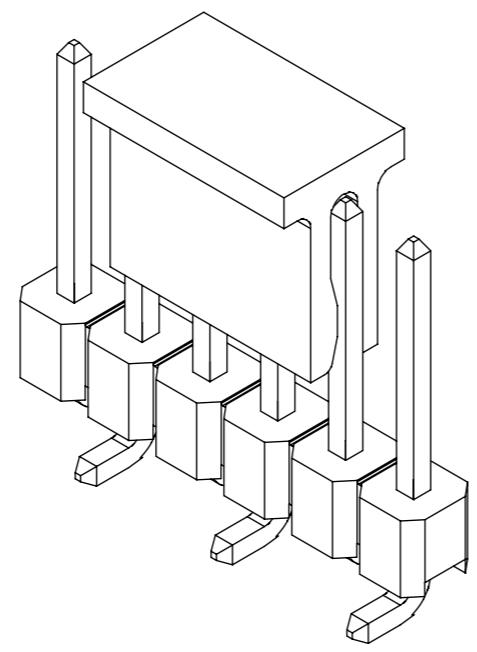
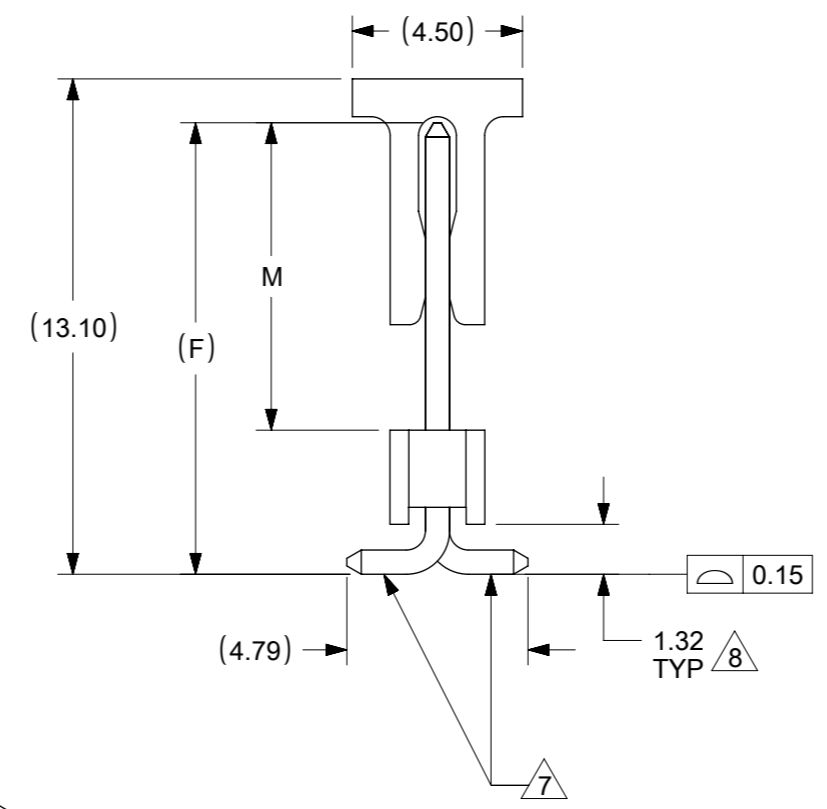
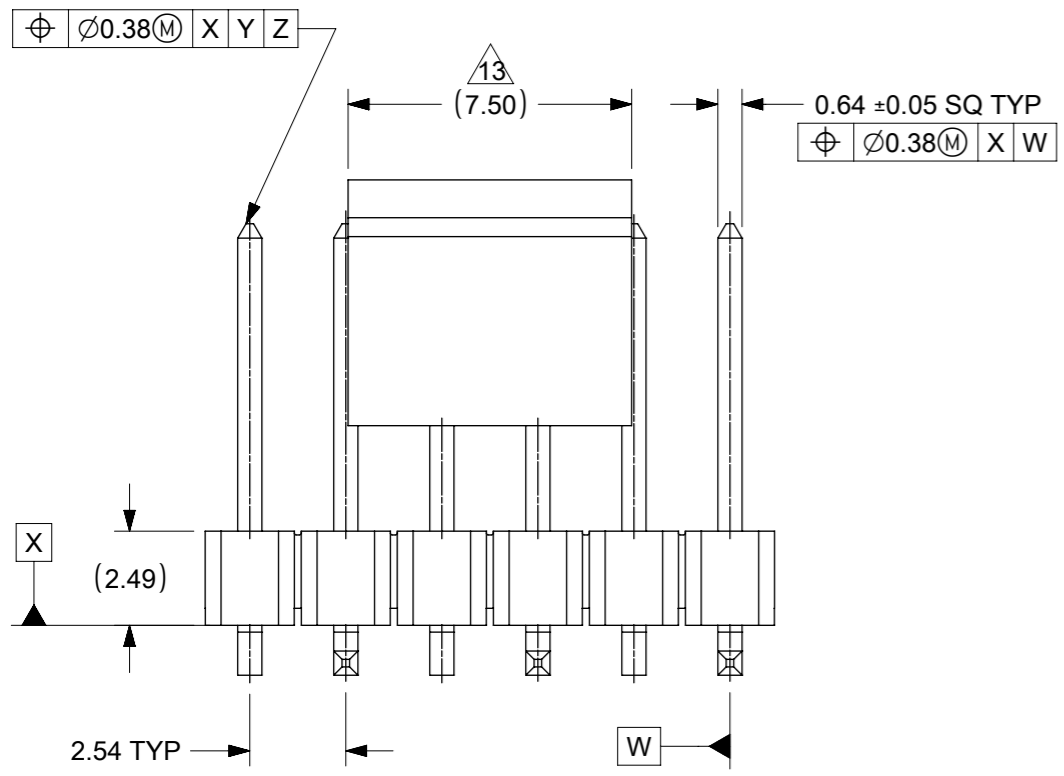

**NOTES:**

1. MATERIAL:  
HSG: NYLON, GLASS-FILLED, UL94V-0, COLOR: BLACK  
PIN: 0.64MM SQ, COPPER ALLOY
2. PLATING TYPE:
  - (1) GOLD FLASH OVER  
1.25µm MIN. NICKEL OVERALL.
  - (2) GOLD FLASH ON CONTACT AND  
2.50µm MIN. TIN ON SOLDER TAIL OVER  
1.25µm MIN. NICKEL OVERALL.
  - (4) 0.38µm MIN. GOLD PLATE ON CONTACT AND  
2.00µm MIN. TIN ON SOLDER TAIL OVER  
1.25µm MIN. NICKEL OVERALL.
  - (5) 0.75µm MIN. GOLD PLATE ON CONTACT AND  
2.00µm MIN. TIN ON SOLDER TAIL OVER  
1.25µm MIN. NICKEL OVERALL.
  - (6) 2.50µm MIN. TIN OVERALL  
1.25µm MIN. NICKEL OVERALL
3. PRODUCT SPECIFICATION: PS-87920-019
4. PACKAGING TYPE: SEE TABLE
5. PACKAGING SPEC: PK-89990-545(TUBE), PK-89990-486(T&R) & PK-87898-400 (T&R)
6. WAFER TO BE FLAT WITHIN 0.003 mm/mm
7. BEND DEPRESSION IS ACCEPTED SO LONG AS IT DOES NOT AFFECT THE OVERALL COPLANARITY OF TAIL
8. COPLANARITY IS TO BE MEASURED BY RESTING THE SOLDER TAIL ON A FLAT SURFACE
9. IRREGULAR CIRCUIT CUTOFF WITHIN BREAKAWAY SECTION IS PERMISSIBLE. CUTTING OR CHIPPING OF THE MAIN BODY IS NOT ACCEPTABLE
10. TUBE LENGTH AS PER STANDARD 560mm
11. RECOMMENDED PCB THICKNESS IS 1.60mm±0.10
12. THE ABOVE CKT 6 IS FOR ILLUSTRATION PURPOSE ONLY
13. CAP LOCATION IS CENTERED ALONG THE MATING ENDS AS SHOWN. TOP SURFACE OF CAP TO BE FLAT FOR THE PURPOSE OF PICK & PLACE BY VACUUM SUCTION NOZZLE.

THIS DRAWING CONTAINS INFORMATION THAT IS PROPRIETARY TO MOLEX ELECTRONIC TECHNOLOGIES, LLC AND SHOULD NOT BE USED WITHOUT WRITTEN PERMISSION		CURRENT REV DESC:		<b>molex</b>	
DIMENSION UNITS: mm		SCALE: NTS			
GENERAL TOLERANCES (UNLESS SPECIFIED)				2.54MM PITCH SINGLE ROW SINGLE WAFER SMT HEADER	
				PRODUCT CUSTOMER DRAWING	
4 PLACES ±				DOCUMENT NUMBER	
3 PLACES ±				SD-87898-003	
2 PLACES ± 0.2				DOC TYPE	
1 PLACE ±				PSD	
0 PLACES ±				DOC PART	
ANGULAR TOL ± 3.0°				001	
DRAFT WHERE APPLICABLE MUST REMAIN WITHIN DIMENSIONS		THIRD ANGLE PROJECTION		REVISION	
		DRAWING: A3-SIZE		C1	
		SERIES: 87898		SHEET NUMBER	
		MATERIAL NUMBER: SEE TABLE		1 OF 17	
		CUSTOMER: GENERAL MARKET			

9 8 7 6 5 4 3 2 1

E

PART WITHOUT CAP  
IN TUBE  
ORIENTATION

PART WITH CAP  
IN TUBE  
ORIENTATION

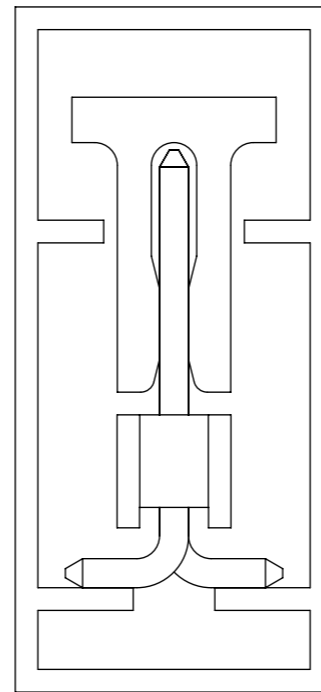
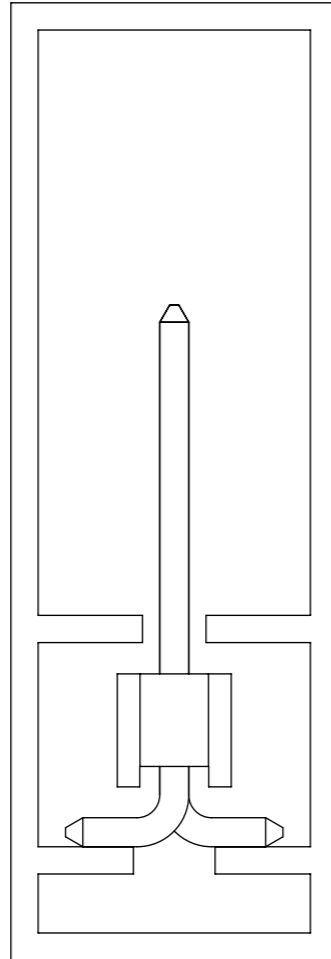

D

C

B

A

THIS DRAWING CONTAINS INFORMATION THAT IS PROPRIETARY TO MOLEX ELECTRONIC TECHNOLOGIES, LLC AND SHOULD NOT BE USED WITHOUT WRITTEN PERMISSION									
DIMENSION UNITS		SCALE		CURRENT REV DESC:				<b>molex</b>	
mm		NTS							
GENERAL TOLERANCES (UNLESS SPECIFIED)				EC NO: 698212				CUSTOM HEADER 2.54MM PITCH SINGLE ROW SINGLE WAFER SMT HEADER	
		MM	INCH	DRWN: DANUSA 2022/03/03					
4 PLACES		±	±	CHK'D: DANUSA 2022/03/04				PRODUCT CUSTOMER DRAWING	
3 PLACES		±	±	APPR: MRAMAKRISHNA 2022/03/04					
2 PLACES		±	0.2	INITIAL REVISION:				DOCUMENT NUMBER	
1 PLACE		±	±	DRWN: SKLIM01 2005/10/26				SD-87898-003	
0 PLACES		±	±	APPR: PTLIM 2005/11/07				DOC TYPE DOC PART REVISION	
ANGULAR TOL		±	3.0°	DRAWING				PSD 001 C1	
DRAFT WHERE APPLICABLE MUST REMAIN WITHIN DIMENSIONS		THIRD ANGLE PROJECTION		SERIES		MATERIAL NUMBER		CUSTOMER	
				A3-SIZE		87898		GENERAL MARKET	
SHEET NUMBER		2 OF 17							

DOCUMENT STATUS	P1	RELEASE DATE	2022/03/04	09:00:56
-----------------	----	--------------	------------	----------

9 8 7 6 5 4 3 2 1

CKT	DIMENSION						QTY/REEL
	Bo	Ao	Ko	F	So	W	
3	8.02	5.20	13.60	11.50	--	24.00	320
4	10.51	5.79	15.05	14.20	28.40	32.00	250
5	13.10	5.20	13.60	11.50	---	24.00	320

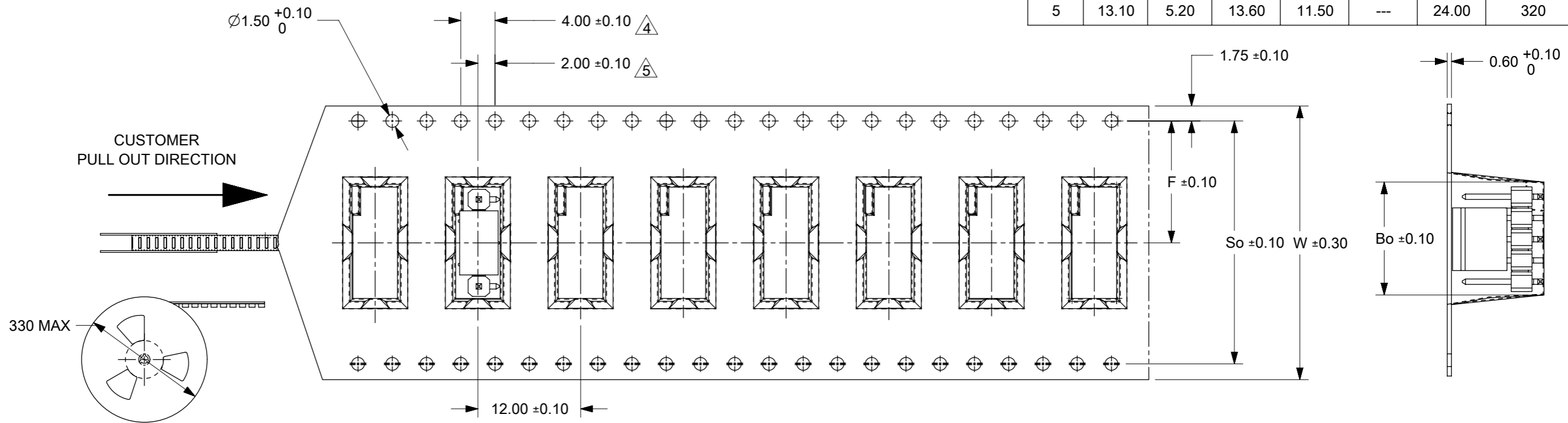

NOTES:

1. LEADER AND TRAILER TAPE

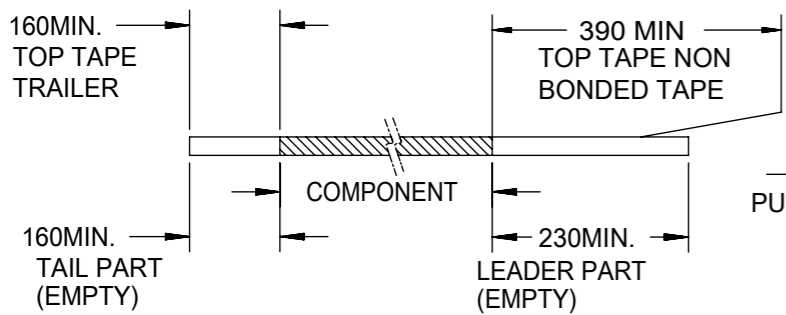

2. PEELING OFF FORCE OF THE TOP TAPE: 20 - 80gf. (PEELING DIRECTION AS SHOWN IN FOLLOWING FIGURE)

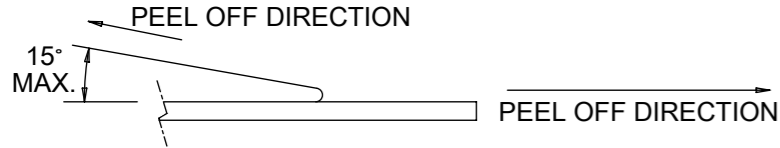

- 3. MATERIAL: BLACK P.S CONDUCTIVE, BLACK
- 4. MEASURED FROM CENTRELINE OF SPROCKET HOLE TO CENTRELINE OF POCKET
- 5. CUMULATIVE TOLERANCE OF 10 SPROCKET HOLE IS ±0.20mm
- 6. A0 AND B0 ARE MEASURE FROM ABOVE POCKET BASE 0.30mm
- 7. TAPE AND REEL SPECIFICATION IS AS PER EIA-481.
- 8. THE TAPE IS TREATED FOR ANTI-STATIC.
- 9. ALL RADIUS ARE 0.30MM UNLESS SPECIFY
- 10. SURFACE RESISTIVITY 10<sup>3</sup> TO 10 OHMS.

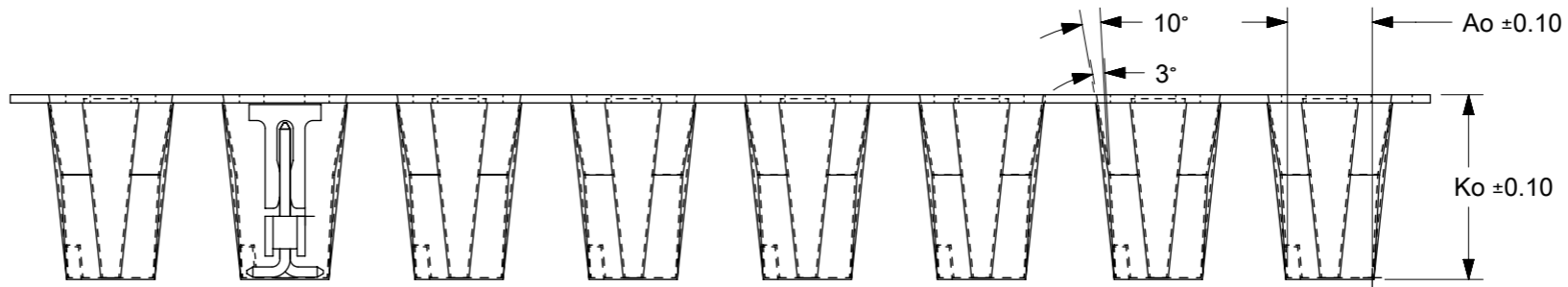

PART PACK IN E/TAPE ORIENTATION (FOR REF USE)

THIS DRAWING CONTAINS INFORMATION THAT IS PROPRIETARY TO MOLEX ELECTRONIC TECHNOLOGIES, LLC AND SHOULD NOT BE USED WITHOUT WRITTEN PERMISSION

DIMENSION UNITS	SCALE	CURRENT REV DESC:		<b>molex</b>		
mm	NTS					
GENERAL TOLERANCES (UNLESS SPECIFIED)		EC NO: 698212		CUSTOMER		
		DRWN: DANUSA 2022/03/03		2.54MM PITCH SINGLE ROW SINGLE WAFER SMT HEADER		
		CHK'D: DANUSA 2022/03/04		PRODUCT CUSTOMER DRAWING		
		APPR: MRAMAKRISHNA 2022/03/04		DOCUMENT NUMBER		
		INITIAL REVISION:		SD-87898-003		
		DRWN: SKLIM01 2005/10/26		DOC TYPE		
		APPR: PTLIM 2005/11/07		PSD		
		ANGULAR TOL ± 3.0°		DOC PART		
		DRAFT WHERE APPLICABLE MUST REMAIN WITHIN DIMENSIONS		001		
		THIRD ANGLE PROJECTION		REVISION		
		DRAWING		C1		
		SERIES		SHEET NUMBER		
		A3-SIZE 87898		3 OF 17		
		MATERIAL NUMBER		CUSTOMER		
		SEE TABLE		GENERAL MARKET		

9 8 7 6 5 4 3 2 1

PACKAGING OPTION PART NO.						CKT SIZE	VOID POSITION	PLATING TYPE	DIMENSION			
TRAY WITHOUT CAP	TRAY WITH CAP	TUBE WITHOUT CAP	TUBE WITH CAP	TAPE & REEL WITHOUT CAP	TAPE & REEL WITH CAP				A	B	F	M
-----	(C) 87898-0361	-----	-----	-----	-----	3	----	1	7.62	5.08	11.94	8.13
-----	(C) 87898-0362	-----	-----	-----	-----	3	----	2	7.62	5.08	11.94	8.13
-----	(C) 87898-0364	-----	-----	-----	87898-0369	3	----	4	7.62	5.08	11.94	8.13
-----	(C) 87898-0365	-----	-----	-----	-----	3	----	5	7.62	5.08	11.94	8.13
-----	(C) 87898-0366	-----	87898-0367	-----	87898-0368	3	----	6	7.62	5.08	11.94	8.13

E

E

D

D

C

C

B

B

A

A

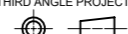
THIS DRAWING CONTAINS INFORMATION THAT IS PROPRIETARY TO MOLEX ELECTRONIC TECHNOLOGIES, LLC AND SHOULD NOT BE USED WITHOUT WRITTEN PERMISSION																
DIMENSION UNITS		SCALE		CURRENT REV DESC:												
mm		NTS														
GENERAL TOLERANCES (UNLESS SPECIFIED)				EC NO: 698212 DRWN: DANUSA 2022/03/03 CHK'D: DANUSA 2022/03/04 APPR: MRAMAKRISHNA 2022/03/04 INITIAL REVISION: DRWN: SKLIM01 2005/10/26 APPR: PTLIM 2005/11/07						CUSTOM HEADER						
										2.54MM PITCH SINGLE ROW SINGLE WAFER SMT HEADER						
										PRODUCT CUSTOMER DRAWING						
										DOCUMENT NUMBER		DOC TYPE	DOC PART	REVISION		
										SD-87898-003		PSD	001	C1		
DRAFT WHERE APPLICABLE MUST REMAIN WITHIN DIMENSIONS				THIRD ANGLE PROJECTION		DRAWING	SERIES	MATERIAL NUMBER	CUSTOMER		SHEET NUMBER					
						A3-SIZE	87898	SEE TABLE	GENERAL MARKET		4 OF 17					

DOCUMENT STATUS	P1	RELEASE DATE	2022/03/04	09:00:56
-----------------	----	--------------	------------	----------

9 8 7 6 5 4 3 2 1

FORMAT: Mel-lega-master-ib-prod-A3  
 REVISION: D  
 DATE: 2018/01/18

PACKAGING OPTION PART NO.						CKT SIZE	PEG	VOID POSITION	PLATING TYPE	DIMENSION			
TRAY WITHOUT CAP	TRAY WITH CAP	TUBE WITHOUT CAP	TUBE WITH CAP	TAPE & REEL WITHOUT CAP	TAPE & REEL WITH CAP					A	B	F	M
-----	-----	87898-0461	-----	-----	-----	4	---	----	1	10.16	7.62	11.94	8.13
-----	-----	87898-0462	-----	-----	-----	4	---	----	2	10.16	7.62	11.94	8.13
-----	-----	87898-0464	-----	-----	-----	4	---	----	4	10.16	7.62	11.94	8.13
-----	-----	87898-0465	-----	-----	-----	4	---	----	5	10.16	7.62	11.94	8.13
-----	-----	87898-0466	-----	-----	87898-0467	4	---	----	6	10.16	7.62	11.94	8.13
-----	-----	-----	-----	-----	87898-0468	4	Y	----	6	10.16	7.62	11.94	8.13
-----	-----	-----	-----	87898-0489	-----	4	Y	----	5	10.16	7.62	16.74	12.93
-----	-----	87898-0561	-----	-----	-----	5	---	----	1	12.70	10.16	11.94	8.13
-----	-----	87898-0562	-----	-----	-----	5	---	----	2	12.70	10.16	11.94	8.13
-----	-----	87898-0564	-----	-----	-----	5	---	----	4	12.70	10.16	11.94	8.13
-----	-----	87898-0565	-----	-----	-----	5	---	----	5	12.70	10.16	11.94	8.13
-----	-----	87898-0566	87898-0567	-----	87898-0568	5	---	----	6	12.70	10.16	11.94	8.13
-----	-----	87898-0661	-----	-----	-----	6	---	----	1	15.24	12.70	11.94	8.13
-----	-----	87898-0662	-----	-----	-----	6	---	----	2	15.24	12.70	11.94	8.13
-----	-----	87898-0664	-----	-----	-----	6	---	----	4	15.24	12.70	11.94	8.13
-----	-----	87898-0665	-----	-----	(C) -----	6	---	----	5	15.24	12.70	11.94	8.13
-----	-----	87898-0666	-----	-----	87898-0605	6	---	----	6	15.24	12.70	11.94	8.13

4 CKT WITH PEG FOR ILLUSTRATION ONLY

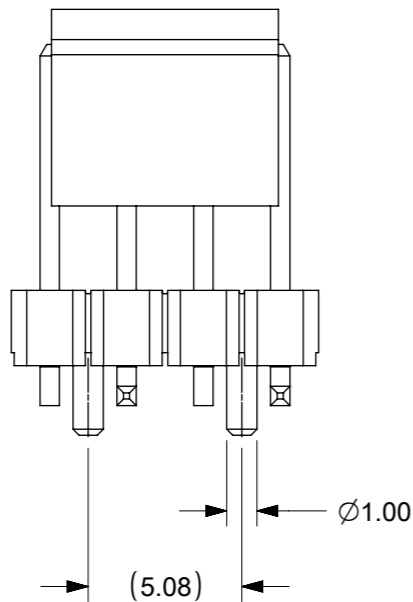

THIS DRAWING CONTAINS INFORMATION THAT IS PROPRIETARY TO MOLEX ELECTRONIC TECHNOLOGIES, LLC AND SHOULD NOT BE USED WITHOUT WRITTEN PERMISSION											
DIMENSION UNITS		SCALE		CURRENT REV DESC:							
mm		NTS		EC NO: 698212							
GENERAL TOLERANCES (UNLESS SPECIFIED)				DRWN: DANUSA		2022/03/03		CUSTOM HEADER 2.54MM PITCH SINGLE ROW SINGLE WAFER SMT HEADER			
4 PLACES ±		±		CHK'D: DANUSA		2022/03/04					
3 PLACES ±		±		APPR: MRAMAKRISHNA		2022/03/04		PRODUCT CUSTOMER DRAWING			
2 PLACES ±		0.2 ±		INITIAL REVISION:				DOCUMENT NUMBER		DOC TYPE	
1 PLACE ±		±		DRWN: SKLIM01				2005/10/26		DOC PART	
0 PLACES ±		±		APPR: PTLIM				2005/11/07		REVISION	
ANGULAR TOL ± 3.0°				DRAWING		SERIES		MATERIAL NUMBER		CUSTOMER	
DRAFT WHERE APPLICABLE MUST REMAIN WITHIN DIMENSIONS				THIRD ANGLE PROJECTION		A3-SIZE		87898		SEE TABLE	
GENERAL MARKET				SHEET NUMBER		5 OF 17					

PACKAGING OPTION PART NO.						CKT SIZE	VOID POSITION	PLATING TYPE	DIMENSION			
TRAY WITHOUT CAP	TRAY WITH CAP	TUBE WITHOUT CAP	TUBE WITH CAP	TAPE & REEL WITHOUT CAP	TAPE & REEL WITH CAP				A	B	F	M
-----	-----	87898-0761	-----	-----	-----	7	----	1	17.78	15.24	11.94	8.13
-----	-----	87898-0762	-----	-----	-----	7	----	2	17.78	15.24	11.94	8.13
-----	-----	87898-0764	-----	-----	-----	7	----	4	17.78	15.24	11.94	8.13
-----	-----	87898-0765	-----	-----	-----	7	----	5	17.78	15.24	11.94	8.13
-----	-----	87898-0766	-----	-----	-----	7	----	6	17.78	15.24	11.94	8.13
-----	-----	87898-0861	-----	-----	-----	8	----	1	20.32	17.78	11.94	8.13
-----	-----	87898-0862	-----	-----	-----	8	----	2	20.32	17.78	11.94	8.13
-----	-----	87898-0864	-----	-----	-----	8	----	4	20.32	17.78	11.94	8.13
-----	-----	87898-0865	-----	-----	-----	8	----	5	20.32	17.78	11.94	8.13
-----	-----	87898-0866	-----	-----	-----	8	----	6	20.32	17.78	11.94	8.13
-----	-----	87898-0961	-----	-----	-----	9	----	1	22.86	20.32	11.94	8.13
-----	-----	87898-0962	-----	-----	-----	9	----	2	22.86	20.32	11.94	8.13
-----	-----	87898-0964	-----	-----	-----	9	----	4	22.86	20.32	11.94	8.13
-----	-----	87898-0965	-----	-----	-----	9	----	5	22.86	20.32	11.94	8.13
-----	-----	87898-0966	-----	-----	-----	9	----	6	22.86	20.32	11.94	8.13

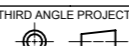
THIS DRAWING CONTAINS INFORMATION THAT IS PROPRIETARY TO MOLEX ELECTRONIC TECHNOLOGIES, LLC AND SHOULD NOT BE USED WITHOUT WRITTEN PERMISSION													
DIMENSION UNITS		SCALE		CURRENT REV DESC:									
mm		NTS											
GENERAL TOLERANCES (UNLESS SPECIFIED)				EC NO: 698212 DRWN: DANUSA 2022/03/03 CHK'D: DANUSA 2022/03/04 APPR: MRAMAKRISHNA 2022/03/04						CUSTOM HEADER 2.54MM PITCH SINGLE ROW SINGLE WAFER SMT HEADER			
4 PLACES		±		INITIAL REVISION: DRWN: SKLIM01 2005/10/26 APPR: PTLIM 2005/11/07						PRODUCT CUSTOMER DRAWING DOCUMENT NUMBER: SD-87898-003 DOC TYPE: PSD DOC PART: 001 REVISION: C1			
3 PLACES		±											
2 PLACES		± 0.2		DRAFT WHERE APPLICABLE MUST REMAIN WITHIN DIMENSIONS						THIRD ANGLE PROJECTION 			
1 PLACE		±											
0 PLACES		±		DRAWING		SERIES		MATERIAL NUMBER		CUSTOMER		SHEET NUMBER	
ANGULAR TOL		± 3.0°		A3-SIZE		87898		SEE TABLE		GENERAL MARKET		6 OF 17	

PACKAGING OPTION PART NO.						CKT SIZE	VOID POSITION	PLATING TYPE	DIMENSION			
TRAY WITHOUT CAP	TRAY WITH CAP	TUBE WITHOUT CAP	TUBE WITH CAP	TAPE & REEL WITHOUT CAP	TAPE & REEL WITH CAP				A	B	F	M
-----	-----	87898-1061	-----	-----	-----	10	----	1	25.40	22.86	11.94	8.13
-----	-----	87898-1062	-----	-----	-----	10	----	2	25.40	22.86	11.94	8.13
-----	-----	87898-1064	-----	-----	-----	10	----	4	25.40	22.86	11.94	8.13
-----	-----	87898-1065	-----	-----	-----	10	----	5	25.40	22.86	11.94	8.13
-----	-----	87898-1066	-----	-----	-----	10	----	6	25.40	22.86	11.94	8.13
-----	-----	87898-1161	-----	-----	-----	11	----	1	27.94	25.40	11.94	8.13
-----	-----	87898-1162	-----	-----	-----	11	----	2	27.94	25.40	11.94	8.13
-----	-----	87898-1164	-----	-----	-----	11	----	4	27.94	25.40	11.94	8.13
-----	-----	87898-1165	-----	-----	-----	11	----	5	27.94	25.40	11.94	8.13
-----	-----	87898-1166	-----	-----	-----	11	----	6	27.94	25.40	11.94	8.13
-----	-----	87898-1261	-----	-----	-----	12	----	1	30.48	27.94	11.94	8.13
-----	-----	87898-1262	-----	-----	-----	12	----	2	30.48	27.94	11.94	8.13
-----	-----	87898-1264	-----	-----	-----	12	----	4	30.48	27.94	11.94	8.13
-----	-----	87898-1265	-----	-----	-----	12	----	5	30.48	27.94	11.94	8.13
-----	-----	87898-1266	-----	-----	-----	12	----	6	30.48	27.94	11.94	8.13

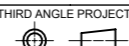
THIS DRAWING CONTAINS INFORMATION THAT IS PROPRIETARY TO MOLEX ELECTRONIC TECHNOLOGIES, LLC AND SHOULD NOT BE USED WITHOUT WRITTEN PERMISSION													
DIMENSION UNITS		SCALE		CURRENT REV DESC:									
mm		NTS											
GENERAL TOLERANCES (UNLESS SPECIFIED)				EC NO: 698212 DRWN: DANUSA 2022/03/03 CHK'D: DANUSA 2022/03/04 APPR: MRAMAKRISHNA 2022/03/04						CUSTOM HEADER 2.54MM PITCH SINGLE ROW SINGLE WAFER SMT HEADER			
4 PLACES		±	±	INITIAL REVISION: DRWN: SKLIM01 2005/10/26 APPR: PTLIM 2005/11/07						PRODUCT CUSTOMER DRAWING DOCUMENT NUMBER: SD-87898-003 DOC TYPE: PSD DOC PART: 001 REVISION: C1			
3 PLACES		±	±										
2 PLACES		± 0.2	±	DRAFT WHERE APPLICABLE MUST REMAIN WITHIN DIMENSIONS						THIRD ANGLE PROJECTION 			
1 PLACE		±	±										
0 PLACES		±	±	DRAWING		SERIES		MATERIAL NUMBER		CUSTOMER		SHEET NUMBER	
ANGULAR TOL		± 3.0°		A3-SIZE		87898		SEE TABLE		GENERAL MARKET		7 OF 17	

PACKAGING OPTION PART NO.						CKT SIZE	VOID POSITION	PLATING TYPE	DIMENSION			
TRAY WITHOUT CAP	TRAY WITH CAP	TUBE WITHOUT CAP	TUBE WITH CAP	TAPE & REEL WITHOUT CAP	TAPE & REEL WITH CAP				A	B	F	M
-----	-----	87898-1361	-----	-----	-----	13	----	1	33.02	30.48	11.94	8.13
-----	-----	87898-1362	-----	-----	-----	13	----	2	33.02	30.48	11.94	8.13
-----	-----	87898-1364	-----	-----	-----	13	----	4	33.02	30.48	11.94	8.13
-----	-----	87898-1365	-----	-----	-----	13	----	5	33.02	30.48	11.94	8.13
-----	-----	87898-1366	-----	-----	-----	13	----	6	33.02	30.48	11.94	8.13
-----	-----	87898-1461	-----	-----	-----	14	----	1	35.56	33.02	11.94	8.13
-----	-----	87898-1462	-----	-----	-----	14	----	2	35.56	33.02	11.94	8.13
-----	-----	87898-1464	-----	-----	-----	14	----	4	35.56	33.02	11.94	8.13
-----	-----	87898-1465	-----	-----	-----	14	----	5	35.56	33.02	11.94	8.13
-----	-----	87898-1466	-----	-----	-----	14	----	6	35.56	33.02	11.94	8.13
-----	-----	87898-1561	-----	-----	-----	15	----	1	38.10	35.56	11.94	8.13
-----	-----	87898-1562	-----	-----	-----	15	----	2	38.10	35.56	11.94	8.13
-----	-----	87898-1564	-----	-----	-----	15	----	4	38.10	35.56	11.94	8.13
-----	-----	87898-1565	-----	-----	-----	15	----	5	38.10	35.56	11.94	8.13
-----	-----	87898-1566	-----	-----	-----	15	----	6	38.10	35.56	11.94	8.13

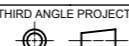
THIS DRAWING CONTAINS INFORMATION THAT IS PROPRIETARY TO MOLEX ELECTRONIC TECHNOLOGIES, LLC AND SHOULD NOT BE USED WITHOUT WRITTEN PERMISSION													
DIMENSION UNITS		SCALE		CURRENT REV DESC:									
mm		NTS											
GENERAL TOLERANCES (UNLESS SPECIFIED)				EC NO: 698212 DRWN: DANUSA 2022/03/03 CHK'D: DANUSA 2022/03/04 APPR: MRAMAKRISHNA 2022/03/04						CUSTOM HEADER 2.54MM PITCH SINGLE ROW SINGLE WAFER SMT HEADER			
		MM	INCH										
4 PLACES	±		±	INITIAL REVISION: DRWN: SKLIM01 2005/10/26 APPR: PTLIM 2005/11/07						PRODUCT CUSTOMER DRAWING DOCUMENT NUMBER: SD-87898-003 DOC TYPE: PSD DOC PART: 001 REVISION: C1			
3 PLACES	±		±										
2 PLACES	±	0.2	±	DRAFT WHERE APPLICABLE MUST REMAIN WITHIN DIMENSIONS						THIRD ANGLE PROJECTION 			
1 PLACE	±		±										
0 PLACES	±		±	DRAWING		SERIES		MATERIAL NUMBER		CUSTOMER		SHEET NUMBER	
ANGULAR TOL ± 3.0°				A3-SIZE		87898		SEE TABLE		GENERAL MARKET		8 OF 17	

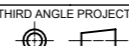

PACKAGING OPTION PART NO.						CKT SIZE	VOID POSITION	PLATING TYPE	DIMENSION			
TRAY WITHOUT CAP	TRAY WITH CAP	TUBE WITHOUT CAP	TUBE WITH CAP	TAPE & REEL WITHOUT CAP	TAPE & REEL WITH CAP				A	B	F	M
-----	-----	87898-1661	-----	-----	-----	16	----	1	40.64	38.10	11.94	8.13
-----	-----	87898-1662	-----	-----	-----	16	----	2	40.64	38.10	11.94	8.13
-----	-----	87898-1664	-----	-----	-----	16	----	4	40.64	38.10	11.94	8.13
-----	-----	87898-1665	-----	-----	-----	16	----	5	40.64	38.10	11.94	8.13
-----	-----	87898-1666	-----	-----	-----	16	----	6	40.64	38.10	11.94	8.13
-----	-----	87898-1761	-----	-----	-----	17	----	1	43.18	40.64	11.94	8.13
-----	-----	87898-1762	-----	-----	-----	17	----	2	43.18	40.64	11.94	8.13
-----	-----	87898-1764	-----	-----	-----	17	----	4	43.18	40.64	11.94	8.13
-----	-----	87898-1765	-----	-----	-----	17	----	5	43.18	40.64	11.94	8.13
-----	-----	87898-1766	-----	-----	-----	17	----	6	43.18	40.64	11.94	8.13
-----	-----	87898-1861	-----	-----	-----	18	----	1	45.72	43.18	11.94	8.13
-----	-----	87898-1862	-----	-----	-----	18	----	2	45.72	43.18	11.94	8.13
-----	-----	87898-1864	-----	-----	-----	18	----	4	45.72	43.18	11.94	8.13
-----	-----	87898-1865	-----	-----	-----	18	----	5	45.72	43.18	11.94	8.13
-----	-----	87898-1866	-----	-----	-----	18	----	6	45.72	43.18	11.94	8.13

THIS DRAWING CONTAINS INFORMATION THAT IS PROPRIETARY TO MOLEX ELECTRONIC TECHNOLOGIES, LLC AND SHOULD NOT BE USED WITHOUT WRITTEN PERMISSION												
DIMENSION UNITS		SCALE		CURRENT REV DESC:								
mm		NTS										
GENERAL TOLERANCES (UNLESS SPECIFIED)				EC NO: 698212 DRWN: DANUSA 2022/03/03 CHK'D: DANUSA 2022/03/04 APPR: MRAMAKRISHNA 2022/03/04				CUSTOM HEADER 2.54MM PITCH SINGLE ROW SINGLE WAFER SMT HEADER				
		MM	INCH									
4 PLACES	±		±	INITIAL REVISION: DRWN: SKLIM01 2005/10/26 APPR: PTLIM 2005/11/07				DOCUMENT NUMBER		DOC TYPE	DOC PART	REVISION
3 PLACES	±		±					SD-87898-003		PSD	001	C1
2 PLACES	±	0.2	±	DRAFT WHERE APPLICABLE MUST REMAIN WITHIN DIMENSIONS				MATERIAL NUMBER		CUSTOMER		SHEET NUMBER
1 PLACE	±		±					SEE TABLE		GENERAL MARKET		9 OF 17
0 PLACES	±		±	THIRD ANGLE PROJECTION		DRAWING	SERIES	CUSTOMER		SHEET NUMBER		
ANGULAR TOL		± 3.0°				A3-SIZE	87898	GENERAL MARKET		9 OF 17		

PACKAGING OPTION PART NO.						CKT SIZE	VOID POSITION	PLATING TYPE	DIMENSION			
TRAY WITHOUT CAP	TRAY WITH CAP	TUBE WITHOUT CAP	TUBE WITH CAP	TAPE & REEL WITHOUT CAP	TAPE & REEL WITH CAP				A	B	F	M
-----	-----	87898-1961	-----	-----	-----	19	----	1	48.26	45.72	11.94	8.13
-----	-----	87898-1962	-----	-----	-----	19	----	2	48.26	45.72	11.94	8.13
-----	-----	87898-1964	-----	-----	-----	19	----	4	48.26	45.72	11.94	8.13
-----	-----	87898-1965	-----	-----	-----	19	----	5	48.26	45.72	11.94	8.13
-----	-----	87898-1966	-----	-----	-----	19	----	6	48.26	45.72	11.94	8.13
-----	-----	87898-2061	-----	-----	-----	20	----	1	50.80	48.26	11.94	8.13
-----	-----	87898-2062	-----	-----	-----	20	----	2	50.80	48.26	11.94	8.13
-----	-----	87898-2064	-----	-----	-----	20	----	4	50.80	48.26	11.94	8.13
-----	-----	87898-2065	-----	-----	-----	20	----	5	50.80	48.26	11.94	8.13
-----	-----	87898-2066	-----	-----	-----	20	----	6	50.80	48.26	11.94	8.13
-----	-----	87898-2161	-----	-----	-----	21	----	1	53.34	50.80	11.94	8.13
-----	-----	87898-2162	-----	-----	-----	21	----	2	53.34	50.80	11.94	8.13
-----	-----	87898-2164	-----	-----	-----	21	----	4	53.34	50.80	11.94	8.13
-----	-----	87898-2165	-----	-----	-----	21	----	5	53.34	50.80	11.94	8.13
-----	-----	87898-2166	-----	-----	-----	21	----	6	53.34	50.80	11.94	8.13

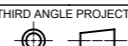
THIS DRAWING CONTAINS INFORMATION THAT IS PROPRIETARY TO MOLEX ELECTRONIC TECHNOLOGIES, LLC AND SHOULD NOT BE USED WITHOUT WRITTEN PERMISSION											
DIMENSION UNITS		SCALE		CURRENT REV DESC:							
mm		NTS		EC NO: 698212							
GENERAL TOLERANCES (UNLESS SPECIFIED)				DRWN: DANUSA		2022/03/03		CUSTOM HEADER 2.54MM PITCH SINGLE ROW SINGLE WAFER SMT HEADER			
				CHK'D: DANUSA		2022/03/04					
				APPR: MRAMAKRISHNA		2022/03/04		PRODUCT CUSTOMER DRAWING			
				INITIAL REVISION:				DOCUMENT NUMBER		DOC TYPE   DOC PART   REVISION	
				DRWN: SKLIM01		2005/10/26		SD-87898-003		PSD   001   C1	
				APPR: PTLIM		2005/11/07		MATERIAL NUMBER		CUSTOMER	
DRAFT WHERE APPLICABLE MUST REMAIN WITHIN DIMENSIONS				THIRD ANGLE PROJECTION		DRAWING		SERIES		SHEET NUMBER	
						A3-SIZE		87898		SEE TABLE   GENERAL MARKET   10 OF 17	

PACKAGING OPTION PART NO.						CKT SIZE	VOID POSITION	PLATING TYPE	DIMENSION			
TRAY WITHOUT CAP	TRAY WITH CAP	TUBE WITHOUT CAP	TUBE WITH CAP	TAPE & REEL WITHOUT CAP	TAPE & REEL WITH CAP				A	B	F	M
-----	-----	87898-2261	-----	-----	-----	22	----	1	55.88	53.34	11.94	8.13
-----	-----	87898-2262	-----	-----	-----	22	----	2	55.88	53.34	11.94	8.13
-----	-----	87898-2264	-----	-----	-----	22	----	4	55.88	53.34	11.94	8.13
-----	-----	87898-2265	-----	-----	-----	22	----	5	55.88	53.34	11.94	8.13
-----	-----	87898-2266	-----	-----	-----	22	----	6	55.88	53.34	11.94	8.13
-----	-----	87898-2361	-----	-----	-----	23	----	1	58.42	55.88	11.94	8.13
-----	-----	87898-2362	-----	-----	-----	23	----	2	58.42	55.88	11.94	8.13
-----	-----	87898-2364	-----	-----	-----	23	----	4	58.42	55.88	11.94	8.13
-----	-----	87898-2365	-----	-----	-----	23	----	5	58.42	55.88	11.94	8.13
-----	-----	87898-2366	-----	-----	-----	23	----	6	58.42	55.88	11.94	8.13
-----	-----	87898-2461	-----	-----	-----	24	----	1	60.96	58.42	11.94	8.13
-----	-----	87898-2462	-----	-----	-----	24	----	2	60.96	58.42	11.94	8.13
-----	-----	87898-2464	-----	-----	-----	24	----	4	60.96	58.42	11.94	8.13
-----	-----	87898-2465	-----	-----	-----	24	----	5	60.96	58.42	11.94	8.13
-----	-----	87898-2466	-----	-----	-----	24	----	6	60.96	58.42	11.94	8.13

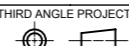
THIS DRAWING CONTAINS INFORMATION THAT IS PROPRIETARY TO MOLEX ELECTRONIC TECHNOLOGIES, LLC AND SHOULD NOT BE USED WITHOUT WRITTEN PERMISSION												
DIMENSION UNITS		SCALE		CURRENT REV DESC:								
mm		NTS										
GENERAL TOLERANCES (UNLESS SPECIFIED)				EC NO: 698212 DRWN: DANUSA 2022/03/03 CHK'D: DANUSA 2022/03/04 APPR: MRAMAKRISHNA 2022/03/04				CUSTOM HEADER 2.54MM PITCH SINGLE ROW SINGLE WAFER SMT HEADER				
		MM	INCH									
4 PLACES	±		±	INITIAL REVISION: DRWN: SKLIM01 2005/10/26 APPR: PTLIM 2005/11/07				DOCUMENT NUMBER		DOC TYPE	DOC PART	REVISION
3 PLACES	±		±					SD-87898-003		PSD	001	C1
2 PLACES	±	0.2	±	DRAFT WHERE APPLICABLE MUST REMAIN WITHIN DIMENSIONS				MATERIAL NUMBER		CUSTOMER		SHEET NUMBER
1 PLACE	±		±					SEE TABLE		GENERAL MARKET		11 OF 17
0 PLACES	±		±	THIRD ANGLE PROJECTION		DRAWING	SERIES	CUSTOMER		SHEET NUMBER		
ANGULAR TOL ± 3.0°				A3-SIZE	87898	GENERAL MARKET		11 OF 17				

PACKAGING OPTION PART NO.						CKT SIZE	VOID POSITION	PLATING TYPE	DIMENSION			
TRAY WITHOUT CAP	TRAY WITH CAP	TUBE WITHOUT CAP	TUBE WITH CAP	TAPE & REEL WITHOUT CAP	TAPE & REEL WITH CAP				A	B	F	M
-----	-----	87898-2561	-----	-----	-----	25	----	1	63.50	60.96	11.94	8.13
-----	-----	87898-2562	-----	-----	-----	25	----	2	63.50	60.96	11.94	8.13
-----	-----	87898-2564	-----	-----	-----	25	----	4	63.50	60.96	11.94	8.13
-----	-----	87898-2565	-----	-----	-----	25	----	5	63.50	60.96	11.94	8.13
-----	-----	87898-2566	-----	-----	-----	25	----	6	63.50	60.96	11.94	8.13
-----	-----	87898-2661	-----	-----	-----	26	----	1	66.04	63.50	11.94	8.13
-----	-----	87898-2662	-----	-----	-----	26	----	2	66.04	63.50	11.94	8.13
-----	-----	87898-2664	-----	-----	-----	26	----	4	66.04	63.50	11.94	8.13
-----	-----	87898-2665	-----	-----	-----	26	----	5	66.04	63.50	11.94	8.13
-----	-----	87898-2666	-----	-----	-----	26	----	6	66.04	63.50	11.94	8.13
-----	-----	87898-2761	-----	-----	-----	27	----	1	68.58	66.04	11.94	8.13
-----	-----	87898-2762	-----	-----	-----	27	----	2	68.58	66.04	11.94	8.13
-----	-----	87898-2764	-----	-----	-----	27	----	4	68.58	66.04	11.94	8.13
-----	-----	87898-2765	-----	-----	-----	27	----	5	68.58	66.04	11.94	8.13
-----	-----	87898-2766	-----	-----	-----	27	----	6	68.58	66.04	11.94	8.13

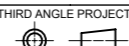
THIS DRAWING CONTAINS INFORMATION THAT IS PROPRIETARY TO MOLEX ELECTRONIC TECHNOLOGIES, LLC AND SHOULD NOT BE USED WITHOUT WRITTEN PERMISSION												
DIMENSION UNITS		SCALE		CURRENT REV DESC:								
mm		NTS										
GENERAL TOLERANCES (UNLESS SPECIFIED)				EC NO: 698212 DRWN: DANUSA 2022/03/03 CHK'D: DANUSA 2022/03/04 APPR: MRAMAKRISHNA 2022/03/04				CUSTOM HEADER 2.54MM PITCH SINGLE ROW SINGLE WAFER SMT HEADER				
		MM	INCH									
4 PLACES	±		±	INITIAL REVISION: DRWN: SKLIM01 2005/10/26 APPR: PTLIM 2005/11/07				DOCUMENT NUMBER		DOC TYPE	DOC PART	REVISION
3 PLACES	±		±					SD-87898-003		PSD	001	C1
2 PLACES	±	0.2	±	DRAFT WHERE APPLICABLE MUST REMAIN WITHIN DIMENSIONS				MATERIAL NUMBER		CUSTOMER		SHEET NUMBER
1 PLACE	±		±					SEE TABLE		GENERAL MARKET		12 OF 17
0 PLACES	±		±	THIRD ANGLE PROJECTION		DRAWING	SERIES	CUSTOMER		SHEET NUMBER		
ANGULAR TOL		± 3.0°				A3-SIZE	87898	GENERAL MARKET		12 OF 17		

PACKAGING OPTION PART NO.						CKT SIZE	VOID POSITION	PLATING TYPE	DIMENSION			
TRAY WITHOUT CAP	TRAY WITH CAP	TUBE WITHOUT CAP	TUBE WITH CAP	TAPE & REEL WITHOUT CAP	TAPE & REEL WITH CAP				A	B	F	M
-----	-----	87898-2861	-----	-----	-----	28	----	1	71.12	68.58	11.94	8.13
-----	-----	87898-2862	-----	-----	-----	28	----	2	71.12	68.58	11.94	8.13
-----	-----	87898-2864	-----	-----	-----	28	----	4	71.12	68.58	11.94	8.13
-----	-----	87898-2865	-----	-----	-----	28	----	5	71.12	68.58	11.94	8.13
-----	-----	87898-2866	-----	-----	-----	28	----	6	71.12	68.58	11.94	8.13
-----	-----	87898-2961	-----	-----	-----	29	----	1	73.66	71.12	11.94	8.13
-----	-----	87898-2962	-----	-----	-----	29	----	2	73.66	71.12	11.94	8.13
-----	-----	87898-2964	-----	-----	-----	29	----	4	73.66	71.12	11.94	8.13
-----	-----	87898-2965	-----	-----	-----	29	----	5	73.66	71.12	11.94	8.13
-----	-----	87898-2966	-----	-----	-----	29	----	6	73.66	71.12	11.94	8.13
-----	-----	87898-3061	-----	-----	-----	30	----	1	76.20	73.66	11.94	8.13
-----	-----	87898-3062	-----	-----	-----	30	----	2	76.20	73.66	11.94	8.13
-----	-----	87898-3064	-----	-----	-----	30	----	4	76.20	73.66	11.94	8.13
-----	-----	87898-3065	-----	-----	-----	30	----	5	76.20	73.66	11.94	8.13
-----	-----	87898-3066	-----	-----	-----	30	----	6	76.20	73.66	11.94	8.13

THIS DRAWING CONTAINS INFORMATION THAT IS PROPRIETARY TO MOLEX ELECTRONIC TECHNOLOGIES, LLC AND SHOULD NOT BE USED WITHOUT WRITTEN PERMISSION

DIMENSION UNITS		SCALE		CURRENT REV DESC:		<b>molex</b>	
mm		NTS		EC NO: 698212			
GENERAL TOLERANCES (UNLESS SPECIFIED)				DRWN: DANUSA 2022/03/03		CUSTOM HEADER 2.54MM PITCH SINGLE ROW SINGLE WAFER SMT HEADER	
				CHK'D: DANUSA 2022/03/04			
				APPR: MRAMAKRISHNA 2022/03/04		PRODUCT CUSTOMER DRAWING	
4 PLACES ±				INITIAL REVISION:		DOCUMENT NUMBER	
3 PLACES ±				DRWN: SKLIM01 2005/10/26		SD-87898-003	
2 PLACES ± 0.2				APPR: PTLIM 2005/11/07		DOC TYPE DOC PART REVISION	
1 PLACE ±						PSD 001 C1	
0 PLACES ±							
ANGULAR TOL ± 3.0°				THIRD ANGLE PROJECTION		MATERIAL NUMBER	
DRAFT WHERE APPLICABLE MUST REMAIN WITHIN DIMENSIONS				DRAWING		CUSTOMER	
				A3-SIZE		GENERAL MARKET	
				SERIES		SHEET NUMBER	
				87898		13 OF 17	

PACKAGING OPTION PART NO.						CKT SIZE	VOID POSITION	PLATING TYPE	DIMENSION			
TRAY WITHOUT CAP	TRAY WITH CAP	TUBE WITHOUT CAP	TUBE WITH CAP	TAPE & REEL WITHOUT CAP	TAPE & REEL WITH CAP				A	B	F	M
-----	-----	87898-3161	-----	-----	-----	31	----	1	78.74	76.20	11.94	8.13
-----	-----	87898-3162	-----	-----	-----	31	----	2	78.74	76.20	11.94	8.13
-----	-----	87898-3164	-----	-----	-----	31	----	4	78.74	76.20	11.94	8.13
-----	-----	87898-3165	-----	-----	-----	31	----	5	78.74	76.20	11.94	8.13
-----	-----	87898-3166	-----	-----	-----	31	----	6	78.74	76.20	11.94	8.13
-----	-----	87898-3261	-----	-----	-----	32	----	1	81.28	78.74	11.94	8.13
-----	-----	87898-3262	-----	-----	-----	32	----	2	81.28	78.74	11.94	8.13
-----	-----	87898-3264	-----	-----	-----	32	----	4	81.28	78.74	11.94	8.13
-----	-----	87898-3265	-----	-----	-----	32	----	5	81.28	78.74	11.94	8.13
-----	-----	87898-3266	-----	-----	-----	32	----	6	81.28	78.74	11.94	8.13
-----	-----	87898-3361	-----	-----	-----	33	----	1	83.82	81.28	11.94	8.13
-----	-----	87898-3362	-----	-----	-----	33	----	2	83.82	81.28	11.94	8.13
-----	-----	87898-3364	-----	-----	-----	33	----	4	83.82	81.28	11.94	8.13
-----	-----	87898-3365	-----	-----	-----	33	----	5	83.82	81.28	11.94	8.13
-----	-----	87898-3366	-----	-----	-----	33	----	6	83.82	81.28	11.94	8.13

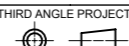
THIS DRAWING CONTAINS INFORMATION THAT IS PROPRIETARY TO MOLEX ELECTRONIC TECHNOLOGIES, LLC AND SHOULD NOT BE USED WITHOUT WRITTEN PERMISSION												
DIMENSION UNITS		SCALE		CURRENT REV DESC:								
mm		NTS										
GENERAL TOLERANCES (UNLESS SPECIFIED)				EC NO: 698212 DRWN: DANUSA 2022/03/03 CHK'D: DANUSA 2022/03/04 APPR: MRAMAKRISHNA 2022/03/04				CUSTOM HEADER 2.54MM PITCH SINGLE ROW SINGLE WAFER SMT HEADER				
		MM	INCH									
4 PLACES	±		±	INITIAL REVISION: DRWN: SKLIM01 2005/10/26 APPR: PTLIM 2005/11/07				DOCUMENT NUMBER		DOC TYPE	DOC PART	REVISION
3 PLACES	±		±					SD-87898-003		PSD	001	C1
2 PLACES	±	0.2	±	DRAFT WHERE APPLICABLE MUST REMAIN WITHIN DIMENSIONS				MATERIAL NUMBER		CUSTOMER		SHEET NUMBER
1 PLACE	±		±					SEE TABLE		GENERAL MARKET		14 OF 17
0 PLACES	±		±	THIRD ANGLE PROJECTION		DRAWING	SERIES	CUSTOMER		SHEET NUMBER		
ANGULAR TOL		± 3.0°				A3-SIZE	87898	GENERAL MARKET		14 OF 17		

PACKAGING OPTION PART NO.						CKT SIZE	VOID POSITION	PLATING TYPE	DIMENSION			
TRAY WITHOUT CAP	TRAY WITH CAP	TUBE WITHOUT CAP	TUBE WITH CAP	TAPE & REEL WITHOUT CAP	TAPE & REEL WITH CAP				A	B	F	M
-----	-----	87898-3461	-----	-----	-----	34	----	1	86.36	83.82	11.94	8.13
-----	-----	87898-3462	-----	-----	-----	34	----	2	86.36	83.82	11.94	8.13
-----	-----	87898-3464	-----	-----	-----	34	----	4	86.36	83.82	11.94	8.13
-----	-----	87898-3465	-----	-----	-----	34	----	5	86.36	83.82	11.94	8.13
-----	-----	87898-3466	-----	-----	-----	34	----	6	86.36	83.82	11.94	8.13
-----	-----	87898-3561	-----	-----	-----	35	----	1	88.90	86.36	11.94	8.13
-----	-----	87898-3562	-----	-----	-----	35	----	2	88.90	86.36	11.94	8.13
-----	-----	87898-3564	-----	-----	-----	35	----	4	88.90	86.36	11.94	8.13
-----	-----	87898-3565	-----	-----	-----	35	----	5	88.90	86.36	11.94	8.13
-----	-----	87898-3566	-----	-----	-----	35	----	6	88.90	86.36	11.94	8.13
-----	-----	87898-3661	-----	-----	-----	36	----	1	91.44	88.90	11.94	8.13
-----	-----	87898-3662	-----	-----	-----	36	----	2	91.44	88.90	11.94	8.13
-----	-----	87898-3664	-----	-----	-----	36	----	4	91.44	88.90	11.94	8.13
-----	-----	87898-3665	-----	-----	-----	36	----	5	91.44	88.90	11.94	8.13
-----	-----	87898-3666	-----	-----	-----	36	----	6	91.44	88.90	11.94	8.13

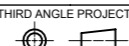
THIS DRAWING CONTAINS INFORMATION THAT IS PROPRIETARY TO MOLEX ELECTRONIC TECHNOLOGIES, LLC AND SHOULD NOT BE USED WITHOUT WRITTEN PERMISSION												
DIMENSION UNITS		SCALE		CURRENT REV DESC:								
mm		NTS										
GENERAL TOLERANCES (UNLESS SPECIFIED)				EC NO: 698212 DRWN: DANUSA 2022/03/03 CHK'D: DANUSA 2022/03/04 APPR: MRAMAKRISHNA 2022/03/04				CUSTOM HEADER 2.54MM PITCH SINGLE ROW SINGLE WAFER SMT HEADER				
		MM	INCH									
4 PLACES	±		±	INITIAL REVISION: DRWN: SKLIM01 2005/10/26 APPR: PTLIM 2005/11/07				DOCUMENT NUMBER		DOC TYPE	DOC PART	REVISION
3 PLACES	±		±					SD-87898-003		PSD	001	C1
2 PLACES	±	0.2	±	DRAFT WHERE APPLICABLE MUST REMAIN WITHIN DIMENSIONS				MATERIAL NUMBER		CUSTOMER		SHEET NUMBER
1 PLACE	±		±					SEE TABLE		GENERAL MARKET		15 OF 17
0 PLACES	±		±	THIRD ANGLE PROJECTION		DRAWING	SERIES	CUSTOMER		SHEET NUMBER		
ANGULAR TOL		± 3.0°				A3-SIZE	87898	GENERAL MARKET		15 OF 17		

PACKAGING OPTION PART NO.						CKT SIZE	VOID POSITION	PLATING TYPE	DIMENSION			
TRAY WITHOUT CAP	TRAY WITH CAP	TUBE WITHOUT CAP	TUBE WITH CAP	TAPE & REEL WITHOUT CAP	TAPE & REEL WITH CAP				A	B	F	M
-----	-----	87898-3761	-----	-----	-----	37	----	1	93.98	91.44	11.94	8.13
-----	-----	87898-3762	-----	-----	-----	37	----	2	93.98	91.44	11.94	8.13
-----	-----	87898-3764	-----	-----	-----	37	----	4	93.98	91.44	11.94	8.13
-----	-----	87898-3765	-----	-----	-----	37	----	5	93.98	91.44	11.94	8.13
-----	-----	87898-3766	-----	-----	-----	37	----	6	93.98	91.44	11.94	8.13
-----	-----	87898-3861	-----	-----	-----	38	----	1	96.52	93.98	11.94	8.13
-----	-----	87898-3862	-----	-----	-----	38	----	2	96.52	93.98	11.94	8.13
-----	-----	87898-3864	-----	-----	-----	38	----	4	96.52	93.98	11.94	8.13
-----	-----	87898-3865	-----	-----	-----	38	----	5	96.52	93.98	11.94	8.13
-----	-----	87898-3866	-----	-----	-----	38	----	6	96.52	93.98	11.94	8.13
-----	-----	87898-3961	-----	-----	-----	39	----	1	99.06	96.52	11.94	8.13
-----	-----	87898-3962	-----	-----	-----	39	----	2	99.06	96.52	11.94	8.13
-----	-----	87898-3964	-----	-----	-----	39	----	4	99.06	96.52	11.94	8.13
-----	-----	87898-3965	-----	-----	-----	39	----	5	99.06	96.52	11.94	8.13
-----	-----	87898-3966	-----	-----	-----	39	----	6	99.06	96.52	11.94	8.13

THIS DRAWING CONTAINS INFORMATION THAT IS PROPRIETARY TO MOLEX ELECTRONIC TECHNOLOGIES, LLC AND SHOULD NOT BE USED WITHOUT WRITTEN PERMISSION											
DIMENSION UNITS		SCALE		CURRENT REV DESC:							
mm		NTS		EC NO: 698212							
GENERAL TOLERANCES (UNLESS SPECIFIED)				DRWN: DANUSA		2022/03/03		CUSTOM HEADER			
				CHK'D: DANUSA		2022/03/04		2.54MM PITCH SINGLE ROW SINGLE WAFER SMT HEADER			
				APPR: MRAMAKRISHNA		2022/03/04		PRODUCT CUSTOMER DRAWING			
				INITIAL REVISION:				DOCUMENT NUMBER		DOC TYPE	
				DRWN: SKLIM01		2005/10/26		SD-87898-003		PSD	
				APPR: PTLIM		2005/11/07		001		C1	
ANGULAR TOL ± 3.0°				DRAFT WHERE APPLICABLE MUST REMAIN WITHIN DIMENSIONS		THIRD ANGLE PROJECTION		DRAWING		SHEET NUMBER	
						A3-SIZE		87898		16 OF 17	
						SERIES		MATERIAL NUMBER		CUSTOMER	
								SEE TABLE		GENERAL MARKET	

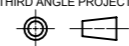

PACKAGING OPTION PART NO.						CKT SIZE	VOID POSITION	PLATING TYPE	DIMENSION			
TRAY WITHOUT CAP	TRAY WITH CAP	TUBE WITHOUT CAP	TUBE WITH CAP	TAPE & REEL WITHOUT CAP	TAPE & REEL WITH CAP				A	B	F	M
-----	-----	87898-4061	-----	-----	-----	40	----	1	101.6	99.06	11.94	8.13
-----	-----	87898-4062	-----	-----	-----	40	----	2	101.6	99.06	11.94	8.13
-----	-----	87898-4064	-----	-----	-----	40	----	4	101.6	99.06	11.94	8.13
-----	-----	87898-4065	-----	-----	-----	40	----	5	101.6	99.06	11.94	8.13
-----	-----	87898-4066	-----	-----	-----	40	----	6	101.6	99.06	11.94	8.13

THIS DRAWING CONTAINS INFORMATION THAT IS PROPRIETARY TO MOLEX ELECTRONIC TECHNOLOGIES, LLC AND SHOULD NOT BE USED WITHOUT WRITTEN PERMISSION																	
DIMENSION UNITS		SCALE		CURRENT REV DESC:													
mm		NTS		EC NO: 698212 DRWN: DANUSA 2022/03/03 CHK'D: DANUSA 2022/03/04 APPR: MRAMAKRISHNA 2022/03/04 INITIAL REVISION: DRWN: SKLIM01 2005/10/26 APPR: PTLIM 2005/11/07								CUSTOMER					
GENERAL TOLERANCES (UNLESS SPECIFIED)										2.54MM PITCH SINGLE ROW SINGLE WAFER SMT HEADER		DOC TYPE		DOC PART		REVISION	
		MM								INCH		PRODUCT CUSTOMER DRAWING					
4 PLACES		±								±		DOCUMENT NUMBER					
3 PLACES		±								±		SD-87898-003					
2 PLACES		± 0.2								±		PSD					
1 PLACE		±		±		001											
0 PLACES		±		±		C1											
ANGULAR TOL		± 3.0°															
DRAFT WHERE APPLICABLE MUST REMAIN WITHIN DIMENSIONS				THIRD ANGLE PROJECTION		DRAWING		SERIES		SHEET NUMBER							
						A3-SIZE		87898		17 OF 17							