

# PERM-O-PADS®

## TO-5 and Integrated Circuit Mounts

### Material Specifications:

White or Natural Nylon, per ASTM D4066 PA111, UL Rated 94V-2

**Oxygen Rating Index:** Over 28%

### Standard Drawing Tolerances:

(unless otherwise indicated)

Fractions:  $\pm 1/64$  (0.4) .XX =  $\pm 0.01$  (0.25)

.X =  $\pm 0.10$  (2.5) .XXX =  $\pm 0.005$  (0.13)

### 502-120

Price Code: A

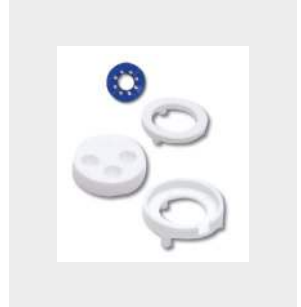
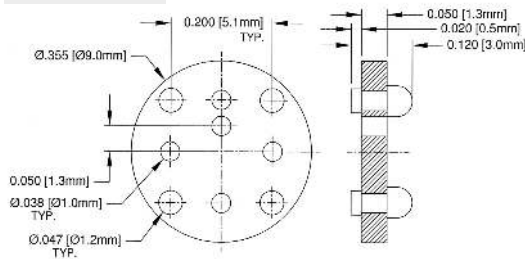

### 505-120

Price Code: A

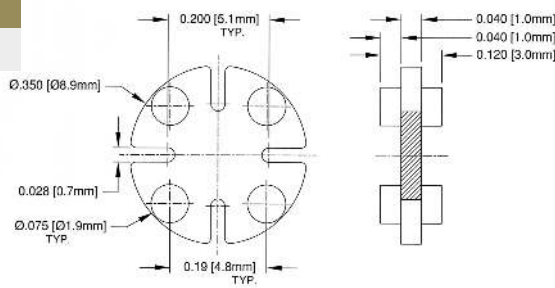

### 510-110

Price Code: A

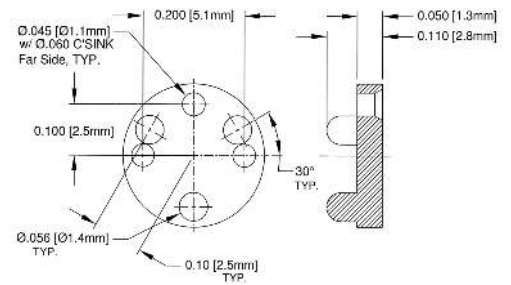

### 512-150

Price Code: A

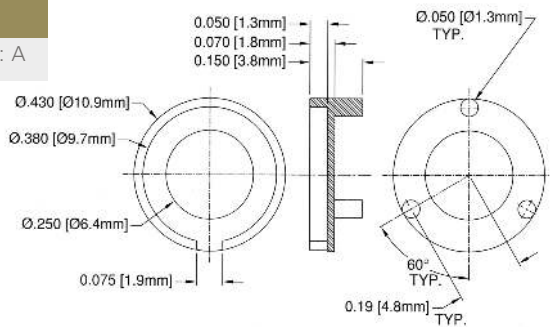

### 517-095

Price Code: A

A55485 / 02-025N  
M38527 / 02-025N

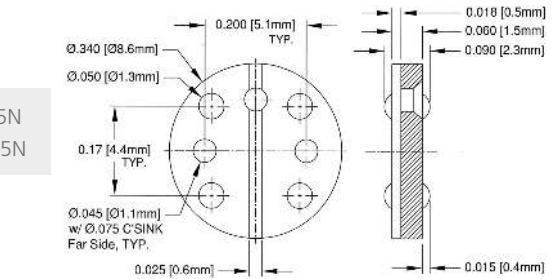

### 521-094

Price Code: A

A55485 / 01-041N  
M38527 / 01-041N

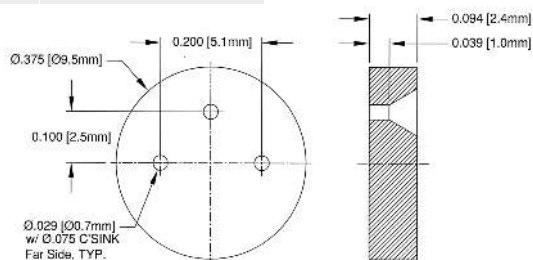

### 528-117

Price Code: A

A55485 / 02-022N  
M38527 / 02-022N

